

Single Switch IGBT Module

PDS5906 1.2 January 2009(LN26569)

FEATURES

- Soft Punch Through Silicon
- Isolated AISiC Base with AlN Substrates
- High Thermal Cycling Capability
- 10µs Short Circuit Withstand
- Lead Free construction
- 10.2kV isolation

APPLICATIONS

- High Reliability Inverters
- Motor Controllers
- Traction Drives
- Choppers

The Powerline range of high power modules includes half bridge, chopper, dual, single and bi-directional switch configurations covering voltages from 1200V to 6500V and currents up to 3600A.

The DIM800XSM33-F000 is a single switch 3300V, soft punch through n-channel enhancement mode, insulated gate bipolar transistor (IGBT) module. The IGBT has a wide bipolar reverse bias safe operating area (RBSOA) plus 10µs short circuit withstand. This device is optimised for traction drives and other applications requiring high thermal cycling capability.

The module incorporates an electrically isolated base plate and low inductance construction enabling circuit designers to optimise circuit layouts and utilise grounded heat sinks for safety.

ORDERING INFORMATION

Order As:

DIM800XSM33-F000

Note: When ordering, please use the complete part number

KEY PARAMETERS

V_{CES}		3300V
$V_{CE(sat)}$ *	(typ)	2.8V
I_C	(max)	800A
$I_{C(PK)}$	(max)	1600A

*(measured at the auxiliary terminals)

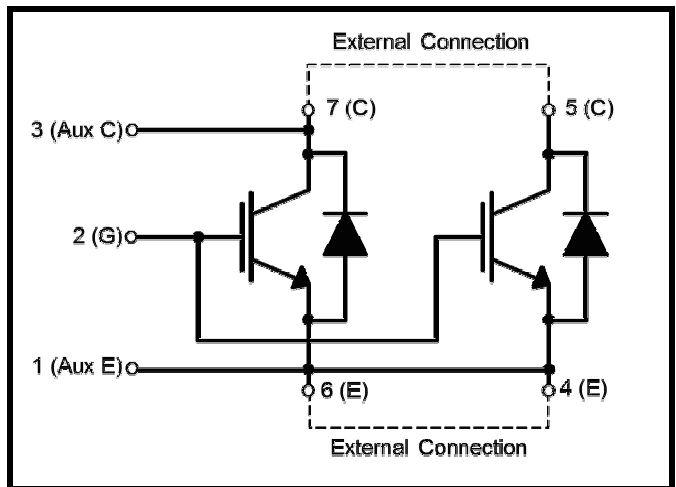

Fig. 1 Circuit configuration



Outline type code: X

(See Fig. 11 for further information)

Fig. 2 Package

ABSOLUTE MAXIMUM RATINGS

Stresses above those listed under 'Absolute Maximum Ratings' may cause permanent damage to the device. In extreme conditions, as with all semiconductors, this may include potentially hazardous rupture of the package. Appropriate safety precautions should always be followed. Exposure to Absolute Maximum Ratings may affect device reliability.

$T_{case} = 25^{\circ}C$ unless stated otherwise

Symbol	Parameter	Test Conditions	Max.	Units
V_{CES}	Collector-emitter voltage	$V_{GE} = 0V$	3300	V
V_{GES}	Gate-emitter voltage		± 20	V
I_C	Continuous collector current	$T_{case} = 90^{\circ}C$	800	A
$I_{C(PK)}$	Peak collector current	1ms, $T_{case} = 115^{\circ}C$	1600	A
P_{max}	Max. transistor power dissipation	$T_{case} = 25^{\circ}C, T_j = 150^{\circ}C$	10.4	kW
I^2t	Diode I^2t value	$V_R = 0V, t_p = 10ms, T_j = 125^{\circ}C$	320	kA^2s
V_{isol}	Isolation voltage	Commoned terminals to base plate. AC RMS, 1 min, 50Hz	10.2	kV
Q_{PD}	Partial discharge	IEC1287. $V_1 = 6900V, V_2 = 5100V, 50Hz$ RMS	10	pC

THERMAL AND MECHANICAL RATINGS

Internal insulation material: AlN
 Baseplate material: AlSiC
 Creepage distance: 56mm
 Clearance: 26mm
 CTI (Critical Tracking Index): >600

Symbol	Parameter	Test Conditions	Min	Typ.	Max	Units
$R_{th(j-c)}$	Thermal resistance - transistor	Continuous dissipation - junction to case			12	$^{\circ}C/kW$
$R_{th(j-c)}$	Thermal resistance - diode	Continuous dissipation - junction to case			24	$^{\circ}C/kW$
$R_{th(c-h)}$	Thermal resistance - case to heatsink	Mounting torque 5Nm (with mounting grease)			8	$^{\circ}C/kW$
T_j	Junction temperature	Transistor			150	$^{\circ}C$
		Diode			125	$^{\circ}C$
T_{stg}	Storage temperature range		-40		125	$^{\circ}C$
	Screw torque	Mounting M6			5	Nm
		Electrical connections – M4			2	Nm
		Electrical connections – M8			10	Nm

2/8: This device is sensitive to electrostatic discharge. Users should follow ESD handling procedures.

ELECTRICAL CHARACTERISTICS
T_{case} = 25° C unless stated otherwise.

Symbol	Parameter	Test Conditions	Min	Typ.	Max	Units	
I _{CES}	Collector cut-off current	V _{GE} = 0V, V _{CE} = V _{CES}			4	mA	
		V _{GE} = 0V, V = V, T _{case} = 125° C			60	mA	
I _{GES}	Gate leakage current	V _{GE} = ±15V, V _{CE} = 0V			1	μA	
V _{GE(TH)}	Gate threshold voltage	I _C = 80mA, V _{GE} = V _{CE}	5.5	6.5	7.0	V	
V _{CE(sat)} [†]	Collector-emitter saturation voltage	V _{GE} = 15V, I _C = 800A		2.8		V	
		V _{GE} = 15V, I _C = 800A, T _J = 125° C		3.6		V	
I _F	Diode forward current	DC		800		A	
I _{FM}	Diode maximum forward current	t _p = 1ms		1600		A	
V _F [†]	Diode forward voltage	I _F = 800A		2.9		V	
		I _F = 800A, T _J = 125° C		3.0		V	
C _{ies}	Input capacitance	V _{CE} = 25V, V _{GE} = 0V, f = 1MHz		144		nF	
C _{res}	Reverse transfer capacitance	V _{CE} = 25V, V _{GE} = 0V, f = 1MHz		2.2		nF	
L _M	Module inductance			20		nH	
R _{INT}	Internal resistance			135		μΩ	
SC _{Data}	Short circuit current, I _{SC}	T _J = 125° C, V _{CC} = 2500V V _{GE} ≤ 15V, t _p ≤ 10μs, V _{CE(max)} = V _{CES} - L* x di/dt IEC 6074-9	I ₁		4000		A
			I ₂		3700		A

Note:
[†] Measured at the auxiliary terminals

^{*} L is the circuit inductance + L_M

ELECTRICAL CHARACTERISTICS

T_{case} = 25 ° C unless stated otherwise

Symbol	Parameter	Test Conditions	Min	Typ.	Max	Units
t _{d(off)}	Turn-off delay time	I _C = 800A		3.0		μs
t _f	Fall time	V _{GE} = ±15V		270		ns
E _{OFF}	Turn-off energy loss	V _{CE} = 1800V		1050		mJ
t _{d(on)}	Turn-on delay time	R _{G(ON)} = 3.9Ω, R _{G(OFF)} = 6.2Ω		1.3		μs
t _r	Rise time	C _{ge} = 220nF, L ~ 100nH		275		ns
E _{ON}	Turn-on energy loss	I _C = 800A, V _{GE} = ±15V, V _{CE} = 1800V, R _{G(ON)} = 2.7Ω, C _{ge} = 220nF, L ~ 100nH		1250		mJ
Q _g	Gate charge			20		μC
Q _{rr}	Diode reverse recovery charge	I _F = 800A		320		μC
I _{rr}	Diode reverse recovery current	V _{CE} = 1800V		670		A
E _{rec}	Diode reverse recovery energy	di _F /dt = 4000A/us		300		mJ

T_{case} = 125 ° C unless stated otherwise

Symbol	Parameter	Test Conditions	Min	Typ.	Max	Units
t _{d(off)}	Turn-off delay time	I _C = 800A		3.1		μs
t _f	Fall time	V _{GE} = ±15V		280		ns
E _{OFF}	Turn-off energy loss	V _{CE} = 1800V		1200		mJ
t _{d(on)}	Turn-on delay time	R _{G(ON)} = 3.9Ω, R _{G(OFF)} = 6.2Ω		1.2		μs
t _r	Rise time	C _{ge} = 220nF, L ~ 100nH		315		ns
E _{ON}	Turn-on energy loss	I _C = 800A, V _{GE} = ±15V, V _{CE} = 1800V, R _{G(ON)} = 2.7Ω, C _{ge} = 220nF, L ~ 100nH		1750		mJ
Q _{rr}	Diode reverse recovery charge	I _F = 800A		600		μC
I _{rr}	Diode reverse recovery current	V _{CE} = 1800V		800		A
E _{rec}	Diode reverse recovery energy	di _F /dt = 4000A/us		600		mJ

4/8: This device is sensitive to electrostatic discharge. Users should follow ESD handling procedures.

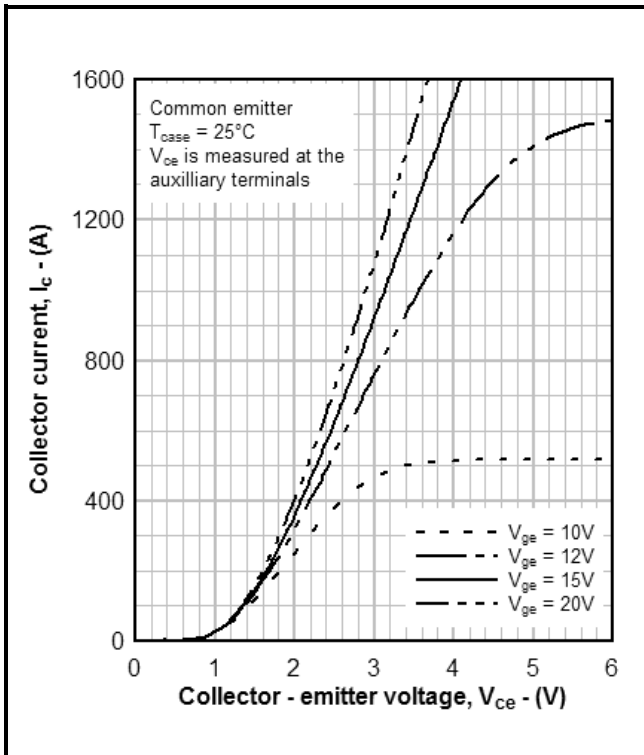

Fig. 3 Typical output characteristics

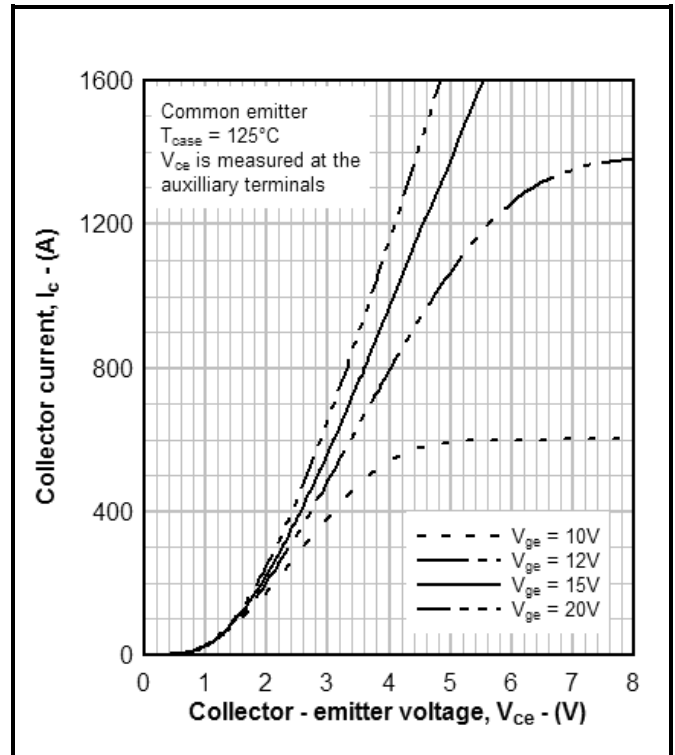

Fig. 4 Typical output characteristics

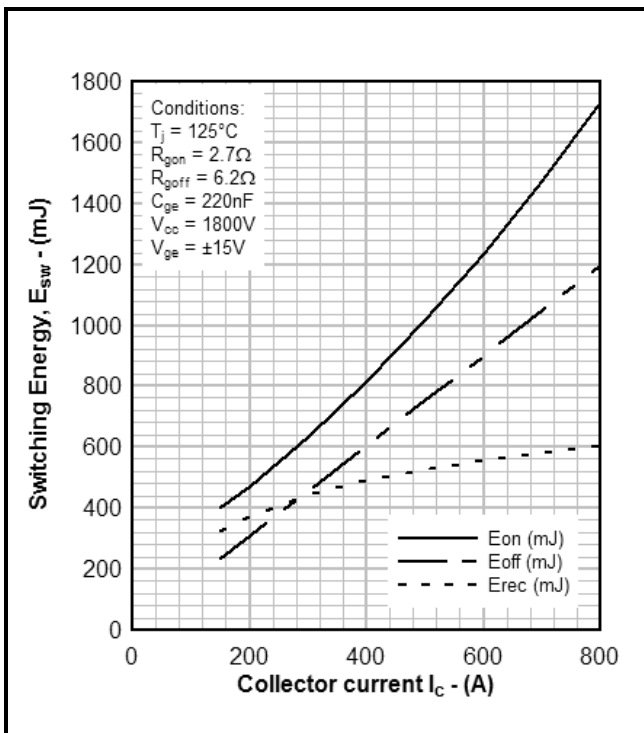

Fig.5 Typical switching energy vs collector current

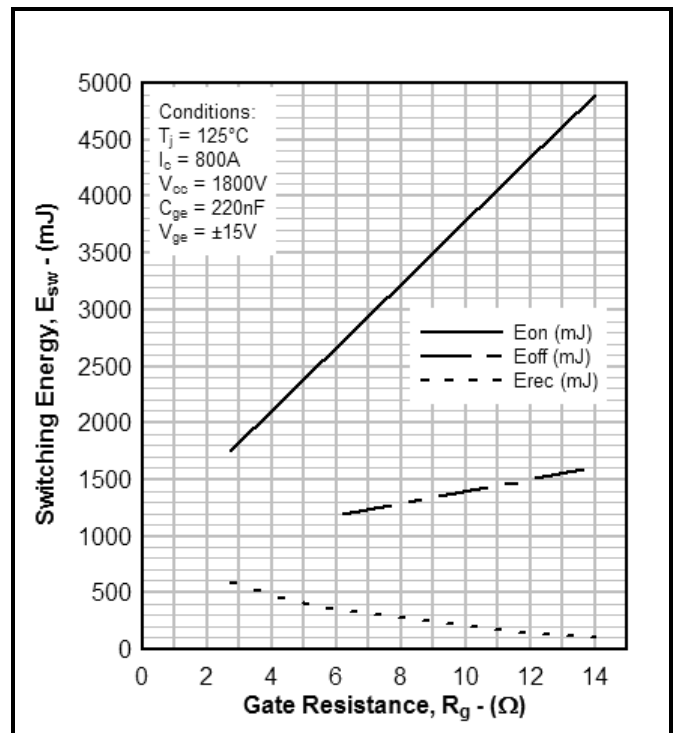

Fig. 6 Typical switching energy vs gate resistance

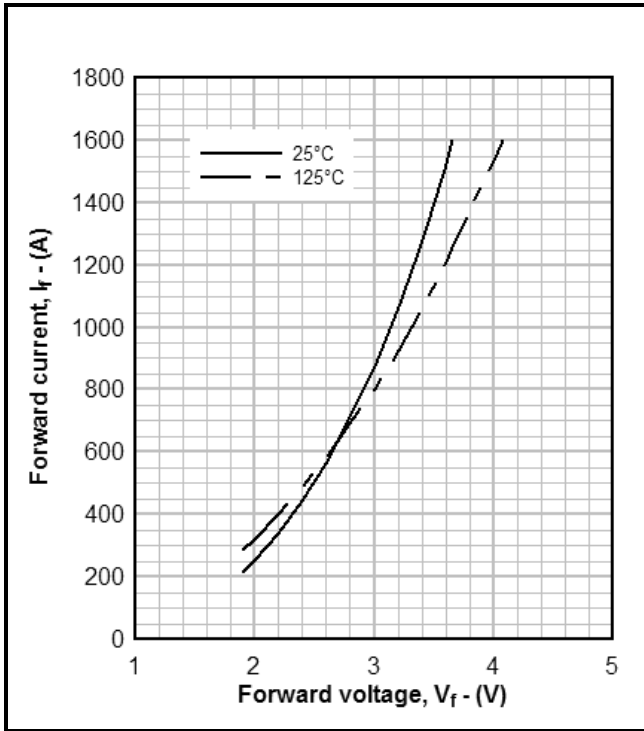

Fig. 7 Diode typical forward characteristics

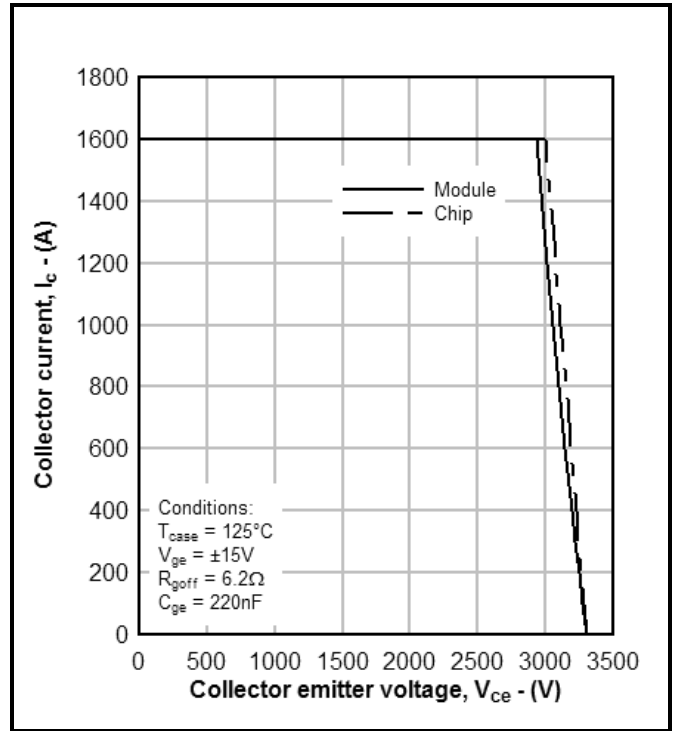

Fig. 8 Reverse bias safe operating area

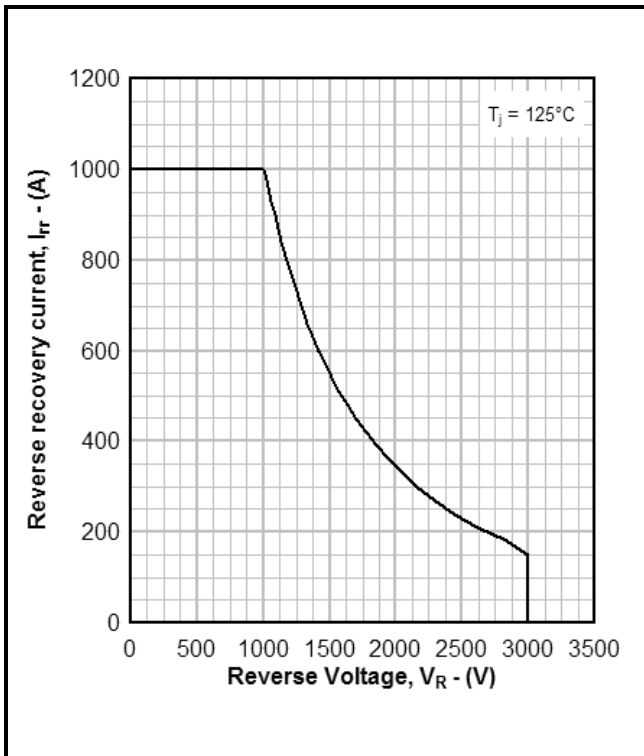

Fig. 9 Diode reverse bias safe operating area

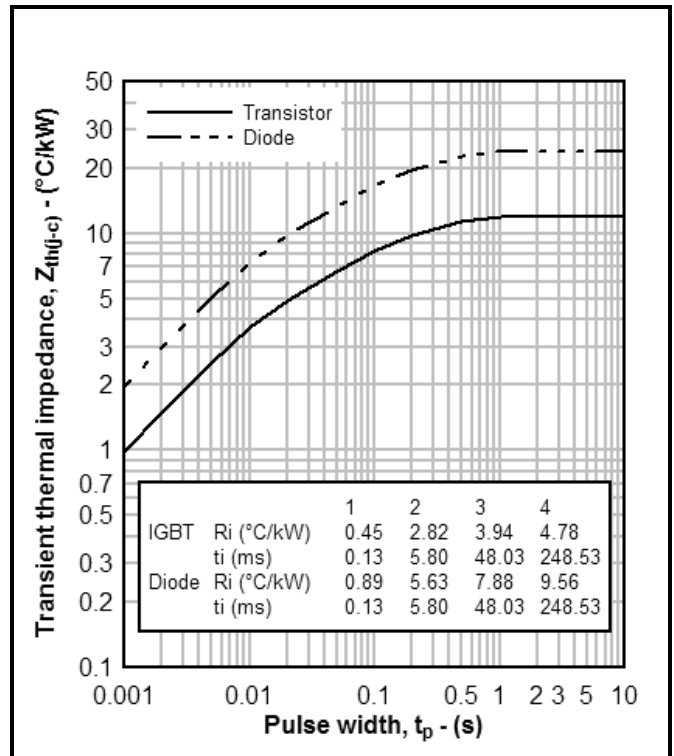
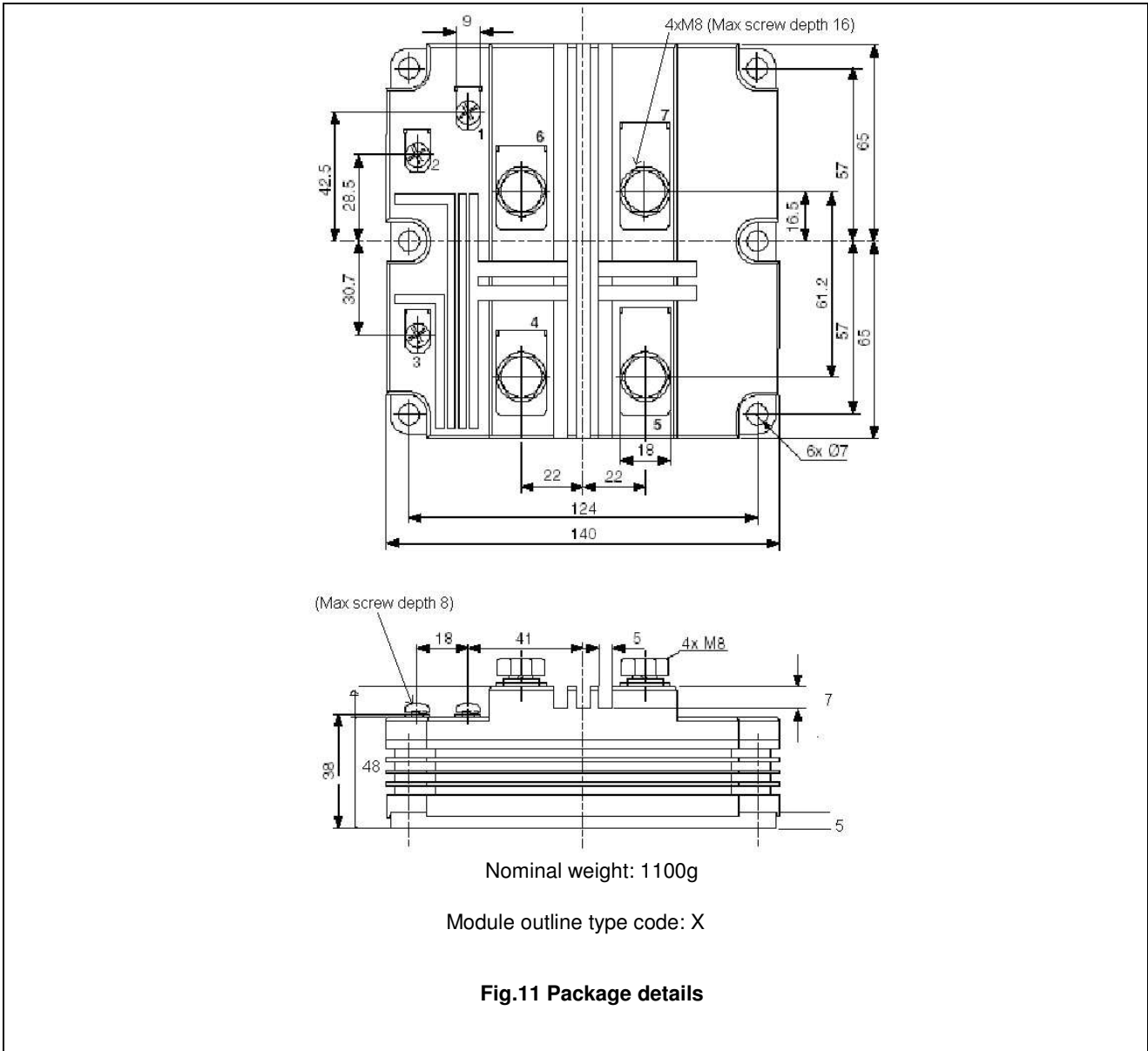

Fig. 10 Transient thermal impedance

PACKAGE DETAILS

For further package information, please visit our website or contact Customer Services. All dimensions in mm, unless stated otherwise.
DO NOT SCALE.



POWER ASSEMBLY CAPABILITY

The Power Assembly group was set up to provide a support service for those customers requiring more than the basic semiconductor, and has developed a flexible range of heatsink and clamping systems in line with advances in device voltages and current capability of our semiconductors.

We offer an extensive range of air and liquid cooled assemblies covering the full range of circuit designs in general use today. The Assembly group offers high quality engineering support dedicated to designing new units to satisfy the growing needs of our customers.

Using the latest CAD methods our team of design and applications engineers aim to provide the Power Assembly Complete Solution (PACs).

HEATSINKS

The Power Assembly group has its own proprietary range of extruded aluminium heatsinks which have been designed to optimise the performance of Dynex semiconductors. Data with respect to air natural, forced air and liquid cooling (with flow rates) is available on request.

For further information on device clamps, heatsinks and assemblies, please contact your nearest sales representative or Customer Services.



<http://www.dynexsemi.com>

e-mail: power_solutions@dynexsemi.com

HEADQUARTERS & OPERATIONS

DYNEX SEMICONDUCTOR LTD
Doddington Road, Lincoln
Lincolnshire, LN6 3LF. United Kingdom.
Fax: +44(0)1522 500550
Tel: +44(0)1522 500500

CUSTOMER SERVICE

DYNEX SEMICONDUCTOR LTD
Doddington Road, Lincoln
Lincolnshire, LN6 3LF. United Kingdom
Fax: +44(0)1522 500020
Tel: +44(0)1522 502753 / 502901

© Dynex Semiconductor 2003 TECHNICAL DOCUMENTATION – NOT FOR RESALE. PRODUCED IN THE UK

Datasheet Annotations: Dynex Semiconductor annotate datasheets in the top right hand corner of the front page, to indicate product status.

The annotations are as follows:-

Target Information: This is the most tentative form of information and represents a very preliminary specification. No actual work on the product has been started

Preliminary Information: The product is in design and development. The datasheet represents the product as it is understood but may change.

Advance Information: The product design is complete and final characterisation for volume production is well in hand.

No Annotation: The product parameters are fixed and the product is available to datasheet specification.

This publication is issued to provide information only which (unless agreed by the Company in writing) may not be used, applied or reproduced for any purpose nor form part of any order or contract nor to be regarded as a representation relating to the products or services concerned. No warranty or guarantee express or implied is made regarding the capability, performance or suitability of any product or service. The Company reserves the right to alter without prior notice the specification, design or price of any product or service. Information concerning possible methods of use is provided as a guide only and does not constitute any guarantee that such methods of use will be satisfactory in a specific piece of equipment. It is the user's responsibility to fully determine the performance and suitability of any equipment using such information and to ensure that any publication or data used is up to date and has not been superseded. These products are not suitable for use in any medical products whose failure to perform may result in significant injury or death to the user. All products and materials are sold and services provided subject to the Company's conditions of sale, which are available on request.

All brand names and product names used in this publication are trademarks, registered trademarks or trade names of their respective owners.

8/8: This device is sensitive to electrostatic discharge. Users should follow ESD handling procedures.