

BLUE-VIOLET LASER DIODE DL-3146-151

SANYO

Ver.5 Jun. 2006

Features

- Short wavelength : 405 nm (Typ.)
- Light Output: 5mW CW
- Low threshold current : I_{th} = 35 mA (Typ.)
- Package : ϕ 5.6 mm

Applications

Industrial Use
Laser module

Absolute Maximum Ratings

(T_c=25°C)

Parameter	Symbol	Ratings	Unit	
Light Output	CW	P _o	7	mW
Reverse Voltage	Laser	VR	2	V
	PD		30	
Operating Temperature	T _{opr}	0 to +60	°C	
Storage Temperature	T _{stg}	-40 to +85	°C	

Electrical and Optical Characteristics ^{1) 2)}

(T_c=25°C)

Parameter	Symbol	Condition	Min.	Typ.	Max.	Unit	
Threshold Current	I _{th}	CW	-	35	55	mA	
Operating Current	I _{op}	P _o =5mW	-	40	60	mA	
Threshold Voltage	V _{th}	CW	-	4.4	5.4	V	
Operating Voltage	V _{op}	P _o =5mW	-	4.5 ⁴⁾	5.5	V	
Lasing Wavelength	L _p	P _o =5mW	395	405	415	nm	
Beam ³⁾ Divergence	Parallel	Q _v	P _o =5mW	16	20	24	°
	Parallel	Q _h	P _o =5mW	6	8	14	°
Off Axis Angle	Perpendicular	dQ _v	-	-3	-	3	°
	Parallel	dQ _h	-	-2	-	2	°
Differential Efficiency	SE	-	0.6	0.9	-	mW/mA	
Monitoring Output Current ⁵⁾	I _m	P _o =5mW	0.1	0.2	0.5	mA	

1) Initial values 2) All the above values are evaluated with Tottori Sanyo's measuring apparatus

3) Full angle at half maximum 4) Operating Voltage of this laser is higher than conventional laser(5.0V)

5) We don't guarantee precision of light output power of this laser diode with an internal monitor diode in an APC circuit for a long period of time.

Note : The above product specification are subject to change without notice.

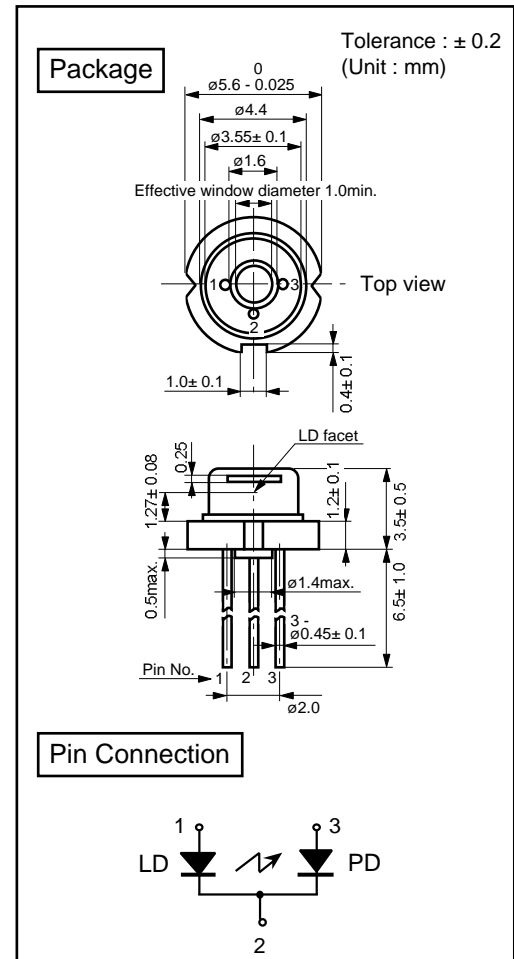



Characteristics Data for DL-3146-151

Reference Data

CONFIDENTIAL

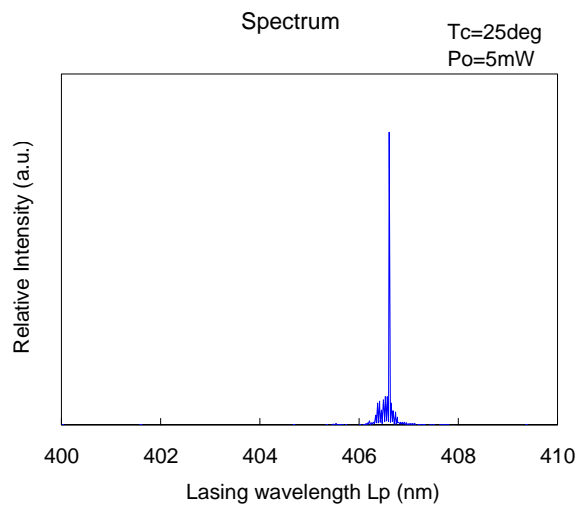
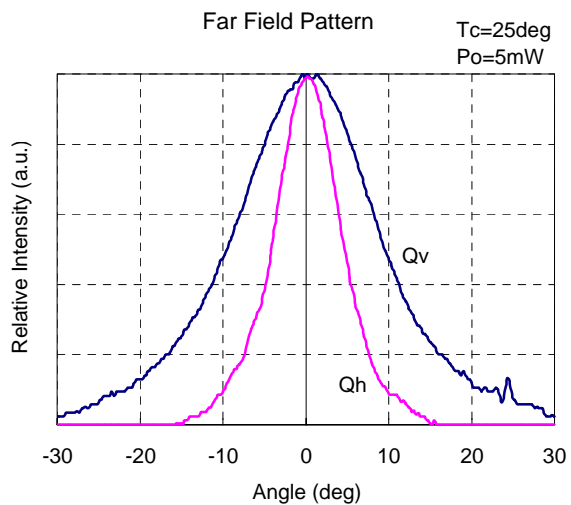
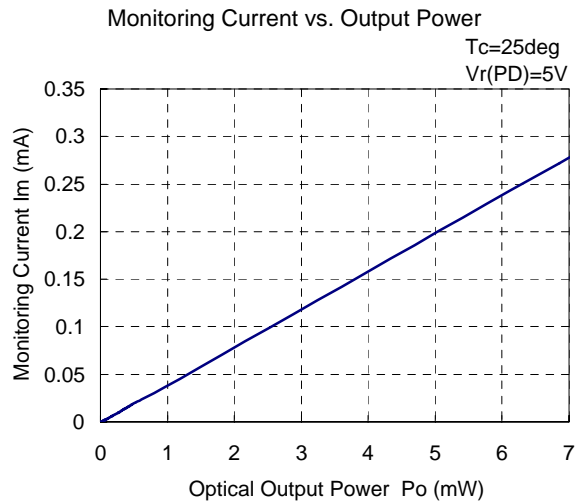
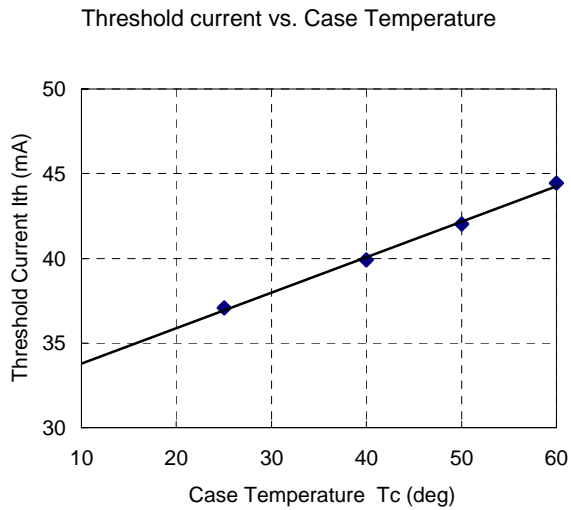
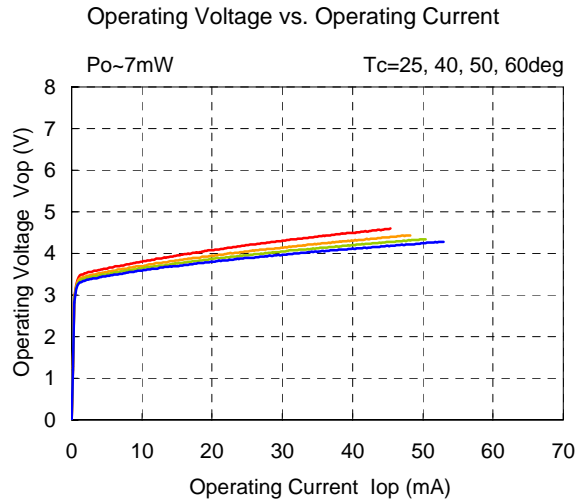
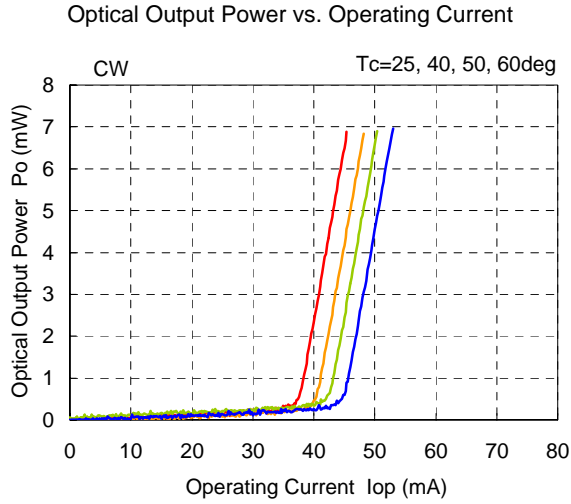

*Those are typical data for customers reference and may not represent all products.



Characteristics Data for DL-3146-151

Reference Data

CONFIDENTIAL

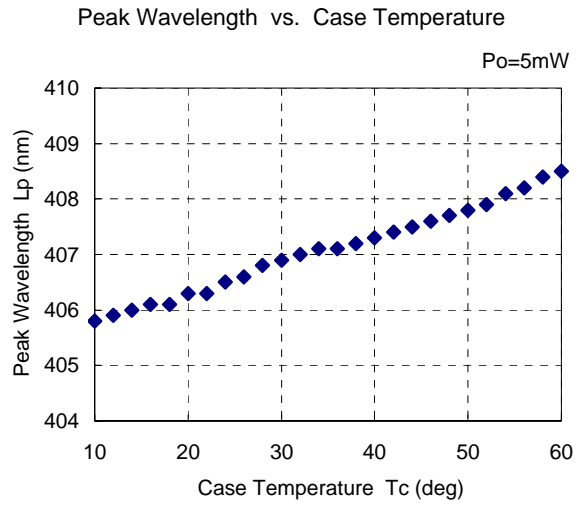
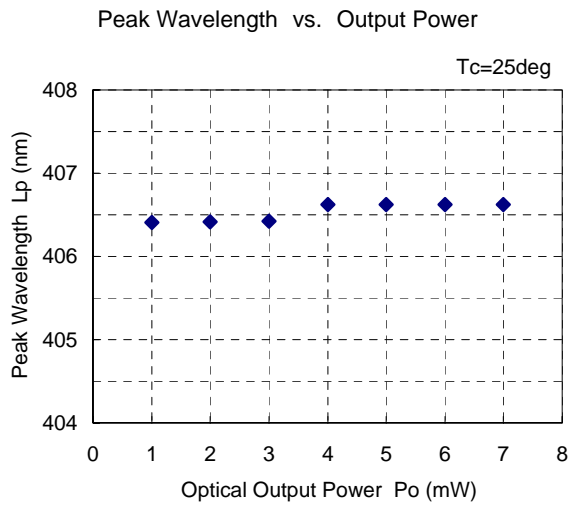

*Those are typical data for customers reference and may not represent all products.

Precautions for Use

1. Voltage of our blue-violet laser diode is 4-6V, which is higher than 1.8-3V of the other laser diodes. Take care of operating voltage when you design an APC circuit.
2. An assembly line has to be protected from static electricity or surge current. Use an earth-band or the like when handling blue-violet laser diodes.
3. Output light from our blue-violet laser diode is very reactive and harmful to a human eye. Avoid looking at the output light directly or even indirectly through a lens while oscillating.
Parts exposed to the output light such as a lens or body should be made from material strong for ultraviolet damage.
4. Don't use our blue-violet laser diode with a built-in monitor photodiode for an application which requires power control with high accuracy.
5. Reselling, disassembling, or reverse engineering of a blue-violet laser diode is prohibited.
6. Our laser diode is not intended for use in applications where extremely high reliability is required, or human life is directly involved, e.g. life-support systems or cars.
7. We are not liable to any undesirable result caused by a misuse or inappropriate use.

Export Control

1. Our laser diode is subject to the export control regulations (of foreign exchanges and foreign trading). When exporting laser diodes (including service), care should be taken to insure that any necessary procedures are complied with.
2. Laser diodes should be destroyed in cases when they are not be used to avoid infringing on export.
3. Use in military applications is prohibited.

Please ask our sales staff for more details if necessary.