

RED LASER DIODE

DL-3147-065



Ver.4 July. 1999

Features

- Short wavelength : 650 nm (Typ.)
- Low threshold current : $I_{th} = 25$ mA (Typ.)
- High operating temperature : 5 mW at 70°C
- TE mode

Applications

DVD-ROM/PLAYER

Absolute Maximum Ratings

($T_c=25^\circ\text{C}$)

Parameter		Symbol	Ratings	Unit
Light Output	CW	P_o	7	mW
Reverse Voltage	Laser	V_R	2	V
	PD		30	
Operating Temperature		T_{opr}	-10 to +70	$^\circ\text{C}$
Storage Temperature		T_{stg}	-40 to +85	$^\circ\text{C}$

Electrical and Optical Characteristics¹⁾²⁾

($T_c=25^\circ\text{C}$)

Parameter		Symbol	Condition	Min.	Typ.	Max.	Unit
Threshold Current		I_{th}	CW	-	25	40	mA
Operating Current		I_{op}	$P_o=5\text{mW}$	-	35	50	mA
Operating Voltage		V_{op}	$P_o=5\text{mW}$	-	2.3	2.6	V
Lasing Wavelength		L_p	$P_o=5\text{mW}$	645	650	660	nm
Beam ³⁾ Divergence	Perpendicular	Q_v	$P_o=5\text{mW}$	25	30	35	$^\circ$
	Parallel	Q_h	$P_o=5\text{mW}$	7.0	8.0	10	$^\circ$
Off Axis Angle	Perpendicular	dQ_v	-	-	-	± 3	$^\circ$
	Parallel	dQ_h	-	-	-	± 2	$^\circ$
Differential Efficiency		dP_o/dI_{op}	-	0.3	0.5	0.8	mW/mA
Monitoring Output Current		I_m	$P_o=5\text{mW}$	0.08	0.2	0.4	mA
Astigmatism		A_s	$P_o=5\text{mW}$	-	8	-	μm

1) Initial values 2) All the above values are evaluated with Tottori Sanyo's measuring apparatus

3) Full angle at half maximum

Note : The above product specification are subject to change without notice.

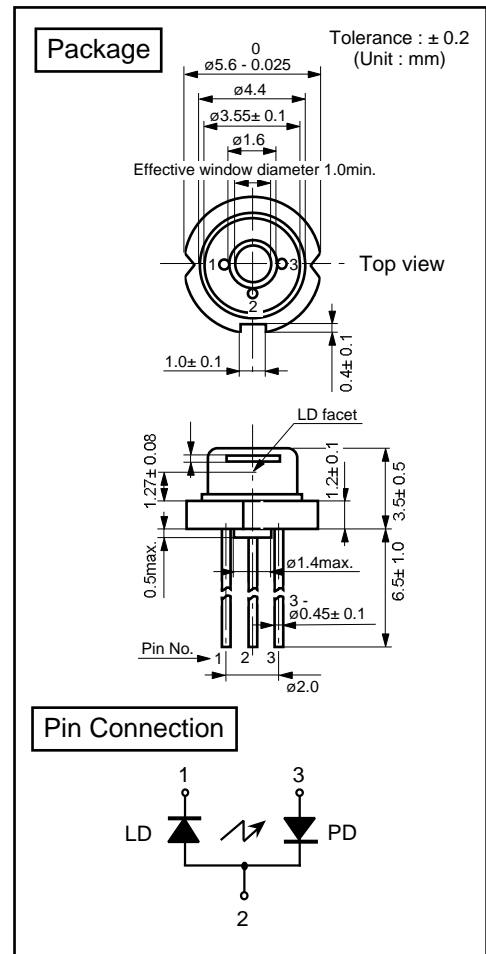

Tottori SANYO Electric Co., Ltd. Electronic Device Business Headquarters
LED Division

Characteristics

Output power vs. Forward current

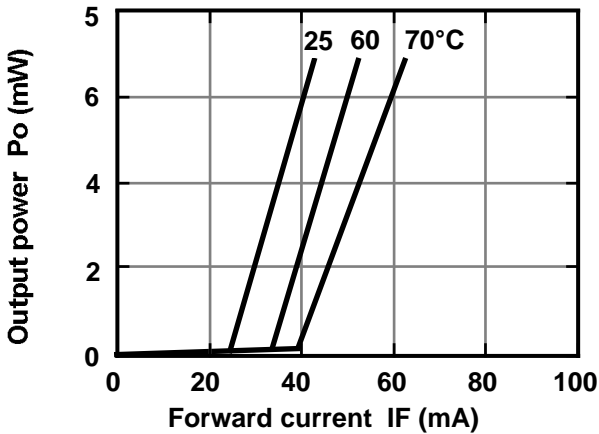

Threshold current vs. Temperature

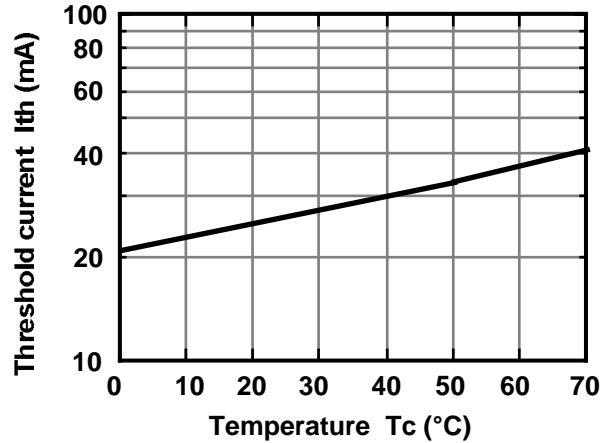

Monitoring current vs. Output power

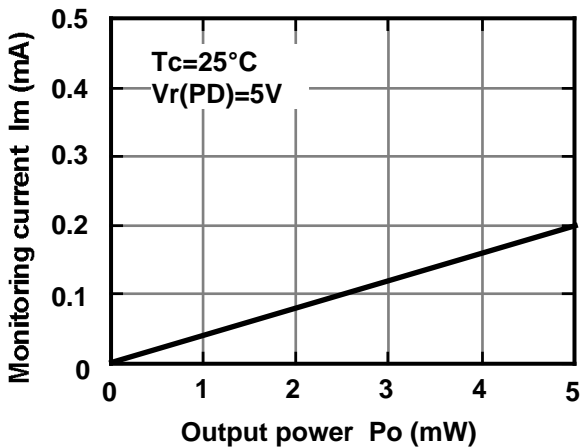

Beam divergence

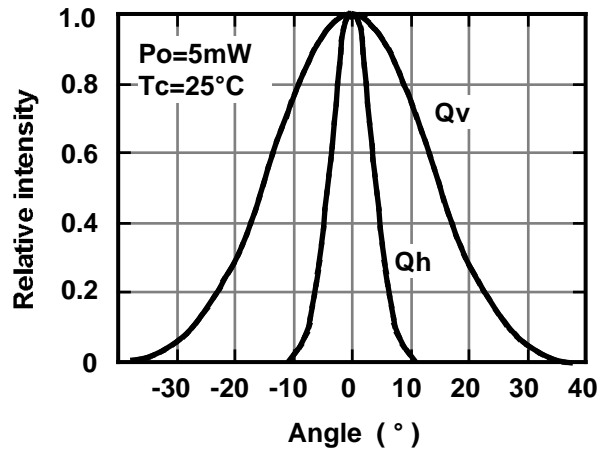

Lasing wavelength vs. Temperature

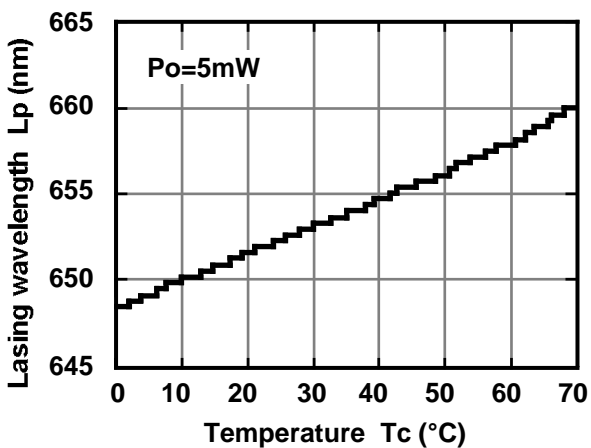

Lasing wavelength vs. Output power

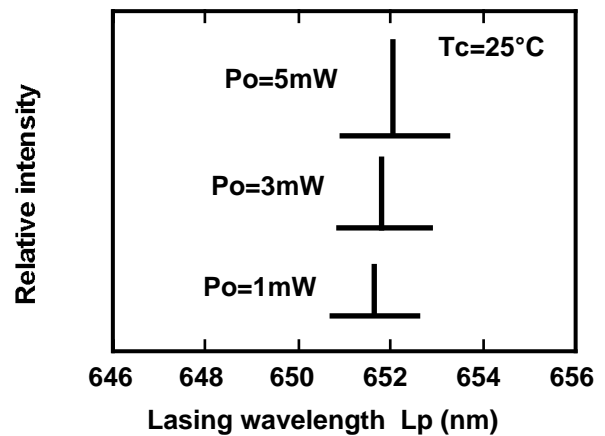

This is typical data and it may not represent all products.