



Micro Commercial Components



Micro Commercial Components  
20736 Marilla Street Chatsworth  
CA 91311  
Phon : (818) 701-4933  
F x: (818) 701-4939

# DLSF11 THRU DLSF18

## Features

- Lead Free Finish/RoHS Compliant(Note 1) ("P" Suffix designates RoHS Compliant. See ordering information)
- Epoxy meets UL 94 V-0 flammability rating
- Moisture Sensitivity Level 1
- Low Leakage and High Surge Capability
- Super Fast Switching Speed For High Efficiency

## Maximum Ratings

- Operating Temperature: -65°C to +150°C
- Storage Temperature: -65°C to +150°C

MCC Catalog Number	Device Marking	Maximum Recurrent Peak Reverse Voltage	Maximum RMS Voltage	Maximum DC Blocking Voltage
DLSF11	---	50V	35V	50V
DLSF12	---	100V	70V	100V
DLSF13	---	150V	105V	150V
DLSF14	---	200V	140V	200V
DLSF15	---	300V	210V	300V
DLSF16	---	400V	280V	400V
DLSF18	---	600V	420V	600V

## 1 Amp Glass Passivated Super Fast Recovery Rectifier 50 to 600 Volts

### MELF

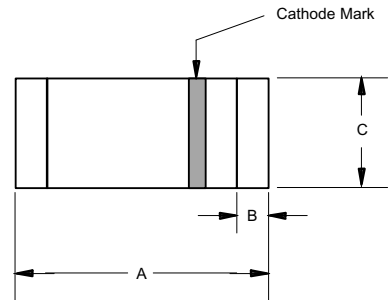

### Electrical Characteristics @ 25°C Unless Otherwise Specified

Parameter	Symbol	Value	Conditions
Average Forward Current	$I_{F(AV)}$	1 A	$T_A = 55^\circ\text{C}$
Peak Forward Surge Current	$I_{FSM}$	30A	8.3ms, half sine
Maximum Instantaneous Forward Voltage	$V_F$	.975V 1.75V	$I_{FM} = 1.0A$ ; $T_A = 25^\circ\text{C}$
Maximum DC Reverse Current At Rated DC Blocking Voltage	$I_R$	5 $\mu\text{A}$ 50 $\mu\text{A}$	$T_A = 25^\circ\text{C}$ $T_A = 150^\circ\text{C}$
Maximum Reverse Recovery Time <sup>16-18</sup>	$T_{rr}$	35ns 50ns	$I_F=0.5A, I_R=1.0A,$ $I_{rr}=0.25A$
Typical Junction Capacitance	$C_J$	15pF 10pF	Measured at 1.0MHz, $V_R=4.0V$

DIM	INCHES		MM		NOTE
	MIN	MAX	MIN	MAX	
A	.185	.205	4.70	5.20	
B	.018	.022	.46	.56	
C	.095	.105	2.40	2.67	∅

### SUGGESTED SOLDER PAD LAYOUT

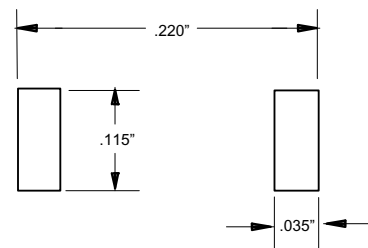

\*Pulse Test: Pulse Width 300 $\mu\text{sec}$ , Duty Cycle 1%

Notes: 1. High Temperature Solder Exemption Applied, see EU Directive Annex Notes 7.

# DLSF11 thru DLSF18

Figure 1  
Typical Forward Characteristics

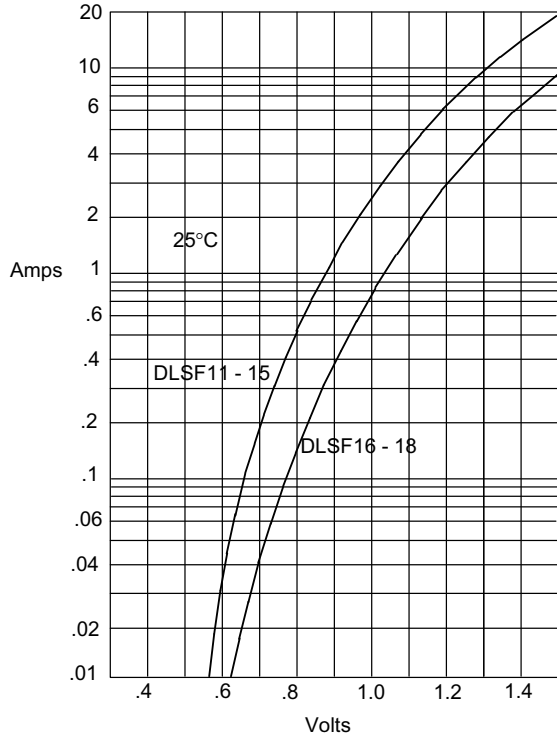

Instantaneous Forward Current - Amperes *versus*  
Instantaneous Forward Voltage - Volts

Figure 2  
Forward Derating Curve

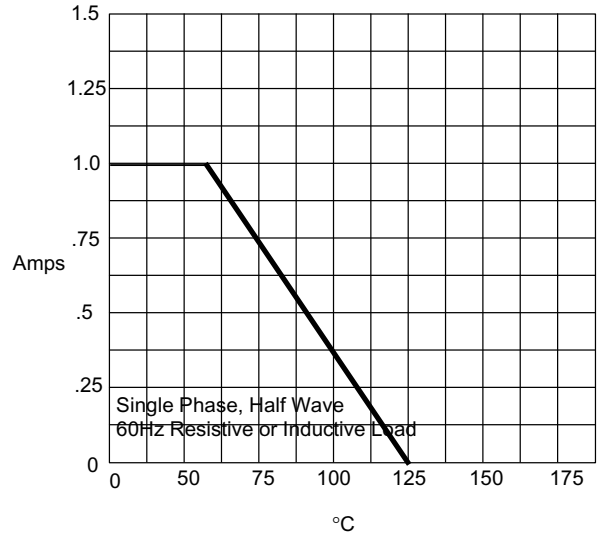

Average Forward Rectified Current - Amperes *versus*  
Ambient Temperature - °C

Figure 3  
Junction Capacitance

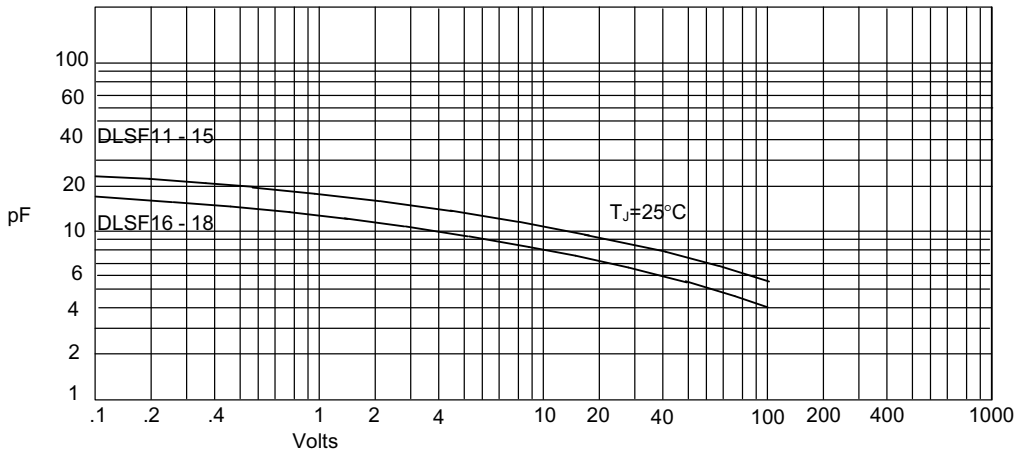

Junction Capacitance - pF *versus*  
Reverse Voltage - Volts

## DLSF11 thru DLSF18

Figure 4  
Typical Reverse Characteristics

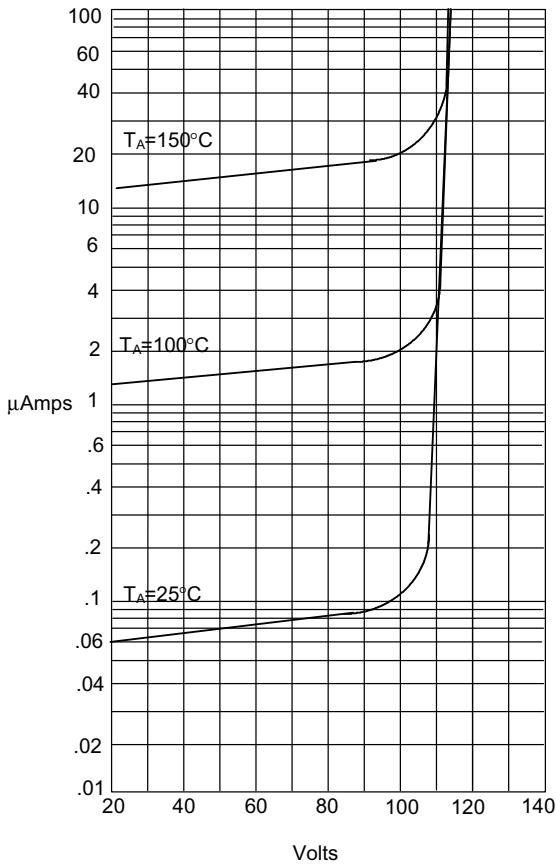

Instantaneous Reverse Leakage Current - MicroAmperes versus Percent Of Rated Peak Reverse Voltage - Volts

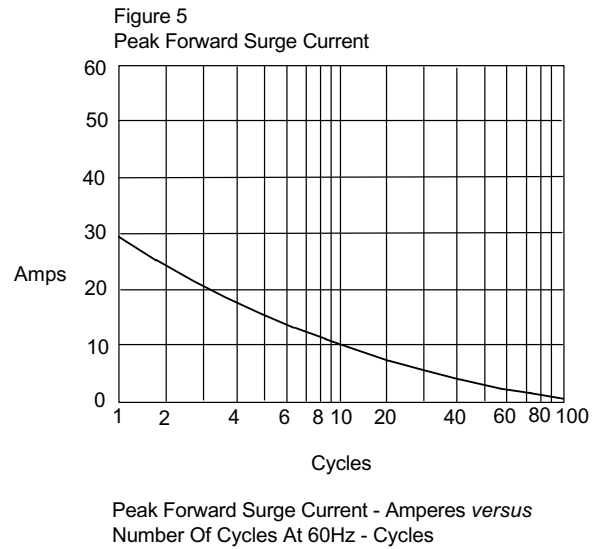

Peak Forward Surge Current - Amperes versus Number Of Cycles At 60Hz - Cycles

Figure 6  
Reverse Recovery Time Characteristic And Test Circuit Diagram

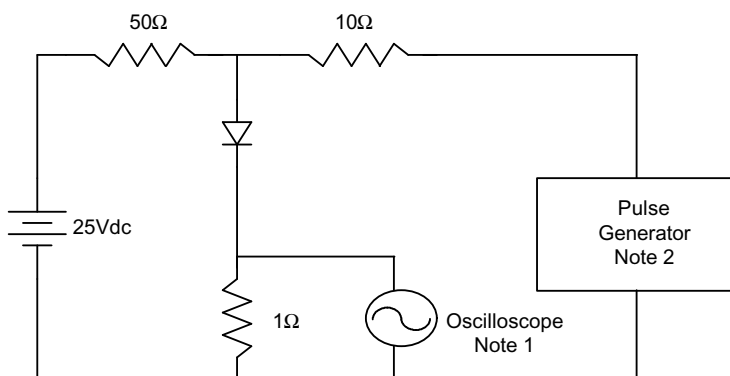

- Notes:
1. Rise Time = 7ns max.  
Input impedance = 1 megohm, 22pF
  2. Rise Time = 10ns max.  
Source impedance = 50 ohms
  3. Resistors are non-inductive

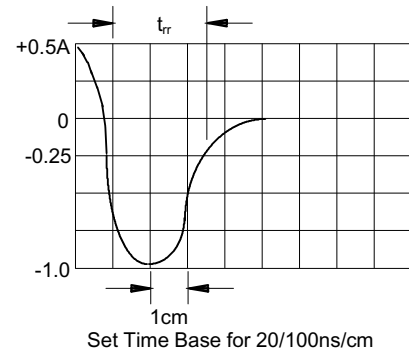



Micro Commercial Components

Ordering Information :

Device	Packing
Part Number-TP	Tape&Reel: 5Kpcs/Reel

\*\*\*IMPORTANT NOTICE\*\*\*

Micro Commercial Components Corp. reserves the right to make changes without further notice to any product herein to make corrections, modifications , enhancements , improvements , or other changes . Micro Commercial Components Corp . does not assume any liability arising out of the application or use of any product described herein; neither does it convey any license under its patent rights ,nor the rights of others . The user of products in such applications shall assume all risks of such use and will agree to hold Micro Commercial Components Corp . and all the companies whose products are represented on our website, harmless against all damages.

\*\*\*LIFE SUPPORT\*\*\*

MCC's products are not authorized for use as critical components in life support devices or systems without the express written approval of Micro Commercial Components Corporation.

\*\*\*CUSTOMER AWARENESS\*\*\*

Counterfeiting of semiconductor parts is a growing problem in the industry. Micro Commercial Components (MCC) is taking strong measures to protect ourselves and our customers from the proliferation of counterfeit parts. MCC strongly encourages customers to purchase MCC parts either directly from MCC or from Authorized MCC Distributors who are listed by country on our web page cited below. Products customers buy either from MCC directly or from Authorized MCC Distributors are genuine parts, have full traceability, meet MCC's quality standards for handling and storage. MCC will not provide any warranty coverage or other assistance for parts bought from Unauthorized Sources. MCC is committed to combat this global problem and encourage our customers to do their part in stopping this practice by buying direct or from authorized distributors.