

Wire Wound Chip Common Mode Choke Coil
DLW5ATH□□□MQ2□ Murata Standard Reference Specification [AEC-Q200]

1. Scope

This reference specification applies to Wire Wound Chip Common Mode Choke Coil DLW5ATH_MQ Series for Automotive Electronics based on AEC-Q200.

2. Part Numbering

(ex.) $\frac{DL}{(1)} \frac{W}{(2)} \frac{5A}{(3)} \frac{T}{(4)} \frac{H}{(5)} \frac{111}{(6)} \frac{M}{(7)} \frac{Q}{(8)} \frac{2}{(9)} \frac{L}{(10)}$

- | | |
|----------------------------------|--|
| (1) Chip Common Mode Choke Coil | (6) Impedance (Typ. at 100MHz) |
| (2) Structure (W : Winding Type) | (7) Circuit |
| (3) Dimension (L × W) | (8) Features |
| (4) Type | (9) Number of Line |
| (5) Category | (10) Packaging Code L : Taping (φ 180mm/reel)
K : Taping (φ 330mm/reel)
B : Bulk |

3. Rating

Customer Part Number	MURATA Part Number	Impedance at 10MHz, Under Standard Testing Conditions (Ω)	Impedance at 100MHz, Under Standard Testing Conditions (ΩTyp.)	Rated Voltage V(DC)	Withstanding Voltage V(DC)	Rated Current ^(*) (A)		DC Resistance (Rdc) (Ω max.)	Insulation Resistance (MΩ min.)	ESD Rank 2.2kV		
						at 105°C	at 125°C					
	DLW5ATH500MQ2L DLW5ATH500MQ2K DLW5ATH500MQ2B	4.6min	50	50	125	4.0	2.5	0.013	10	2		
	DLW5ATH151MQ2L DLW5ATH151MQ2K DLW5ATH151MQ2B					11min	150	3.0			2.0	0.020
	DLW5ATH331MQ2L DLW5ATH331MQ2K DLW5ATH331MQ2B							20min			330	2.5
	DLW5ATH501MQ2L DLW5ATH501MQ2K DLW5ATZ501MQ2B	35min	500									2.0
	DLW5ATH112MQ2L DLW5ATH112MQ2K DLW5ATH112MQ2B					50min	1100					1.5

(*)As for DLW5ATH_MQ type Rated Current is derated as following figure depending on the operating temperature.

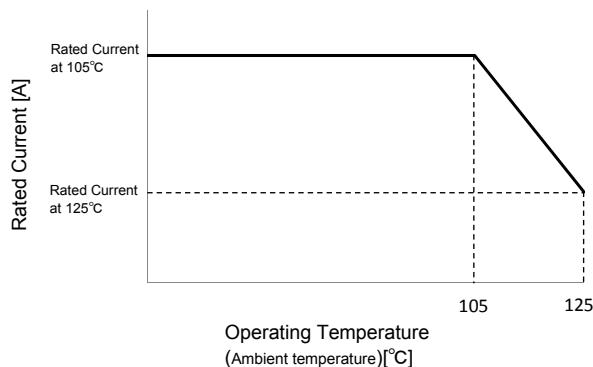

· Operating Temperature : - 40 °C to + 125 °C · Storage Temperature : - 40 °C to + 125 °C

4. Standard Testing Conditions

< Unless otherwise specified >

Temperature : Ordinary Temp. 15 °C to 35 °C

Humidity : Ordinary Humidity 25 %(RH) to 85 %(RH)

< In case of doubt >

Temperature : 20 °C ± 2 °C

Humidity : 60 %(RH) to 70 %(RH)

Atmospheric pressure : 86 kPa to 106 kPa

5. Style and Dimensions

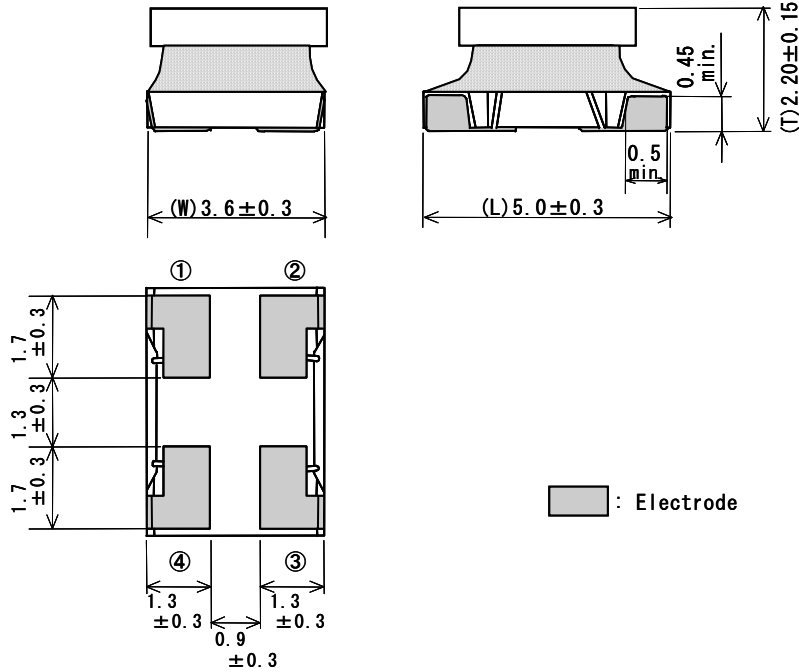

Equivalent Circuits

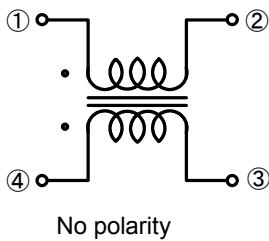

Unit Mass (Typical value)

0.14g

6. Marking

No marking.

7. Electrical Performance

No.	Item	Specifications	Test Method
7.1	Impedance (Z) (at 10MHz)	Meet item 3.	Measuring Equipment : KEYSIGHT 4191A or the equivalents. Measuring Frequency : 10MHz (ref. Item 9.)
7.2	Insulation Resistance (I.R.)		Measuring Equipment : R8340A or the equivalents. Measuring voltage : Rated Voltage Time : within 60 s (ref. Item 9.)
7.3	DC Resistance (Rdc)		Measuring Current : 100 mA max. (ref. Item 9.) (In case of doubt in the above mentioned standard condition, measure by 4 terminal method.)
7.4	Withstanding Voltage	Products shall not be damaged.	Test Voltage : 2.5 times for Rated Voltage Time : 1 to 5 seconds Charge Current : 1 mA max. (ref. Item 9.)

Reference Only

8. Q200 Requirement

7-1. Performance (based on Table 13 for Ferrite EMI SUPPRESSORS/FILTERS)

AEC-Q200 Rev.D issued June 1. 2010

AEC-Q200			Murata Specification / Deviation								
No.	Stress	Test Method									
3	High Temperature Exposure	1000hours at 125 deg C Set for 24hours at room temperature, then measured.	Meet Table A after testing. Table A <table border="1" style="margin-left: 20px; border-collapse: collapse;"> <tr> <td style="padding: 2px;">Appearance</td> <td style="padding: 2px;">No damaged.</td> </tr> <tr> <td style="padding: 2px;">Impedance change (at 10MHz)</td> <td style="padding: 2px;">within ± 20%</td> </tr> <tr> <td style="padding: 2px;">I.R.</td> <td style="padding: 2px;">10MΩ min.</td> </tr> <tr> <td style="padding: 2px;">Withstanding Voltage</td> <td style="padding: 2px;">No damaged.</td> </tr> </table>	Appearance	No damaged.	Impedance change (at 10MHz)	within ± 20%	I.R.	10MΩ min.	Withstanding Voltage	No damaged.
Appearance	No damaged.										
Impedance change (at 10MHz)	within ± 20%										
I.R.	10MΩ min.										
Withstanding Voltage	No damaged.										
4	Temperature Cycling	1000cycles -40 deg C to +125 deg C Set for 24hours at room temperature, then measured.	Meet Table A after testing.								
5	Destructive Physical Analysis	Per EIA469 No electrical tests	Not Applicable								
7	Biased Humidity	1000hours at 85 deg C, 85%RH Apply max rated voltage and current.	Meet Table A after testing. Apply rated voltage. (ref.item 9)								
8	Operational Life	Apply 125 deg C 1000hours Set for 24hours at room temperature, then measured	Meet Table A after testing. Apply derating of rated current. (ref.item 9)								
9	External Visual	Visual inspection	No abnormalities								
10	Physical Dimension	Meet ITEM 5 (Style and Dimensions)	No defects								
12	Resistance to Solvents	Per MIL-STD-202 Method 215	Not Applicable								
13	Mechanical Shock	Per MIL-STD-202 Method 213 Conditon F: 1500g's(14.7N)/0.5ms/ Half sine	Meet Table A after testing.								
14	Vibration	5g's(0.049N) for 20 minutes, 12cycles each of 3 orientations Test from 10-2000Hz. 12cycles each of 3 orientations	Meet Table A after testing.								
15	Resistance to Soldering Heat	No-heating Solder temperature 260C+/-5 deg C Immersion time 10s	Pre-heating : 150 C / 60s min. Meet Table A after testing.								
17	ESD	Per AEC-Q200-002	Meet Table A after testing. ESD Rank: Refer to Item 3. Rating.								
18	Solderbility	Per J-STD-002	Method b : Not Applicable 90% of the terminations is to be soldered. (except partly-exposed wire) Flux:Ethanol solution of rosin,25(wt)% includes activator equivalent to 0.06 to 0.10(wt)% chlorine								
19	Electrical Characterization	Measured : Impedance	No defects								

Reference Only

AEC-Q200			Murata Specification / Deviation
No.	Stress	Test Method	
20	Flammability	Per UL-94	Not Applicable
21	Board Flex	Epoxy-PCB(1.6mm) Deflection 2mm(min) 60 sec minimum holding time	Meet Table A after testing. 30 sec minimum holding time
22	Terminal Strength	Per AEC-Q200-006 A force of 17.7N for 60sec	No defects
30	Electrical Transient Conduction	Per ISO-7637-2	Not Applicable

9. Terminal to be Tested When measuring and suppling the voltage, the following terminal is applied.

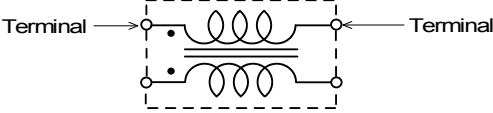
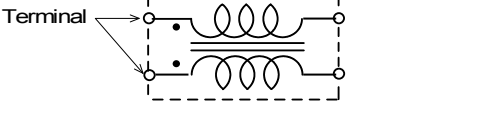
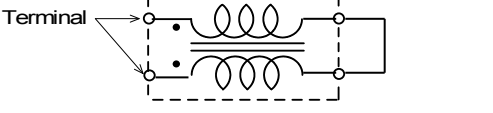
No.	Item	Terminal to be Tested
9.1	Impedance (Z) (Measurement Terminal)	
9.2	DC Resistance (Rdc) (Measurement Terminal)	
9.3	Insulation Resistance (I.R.) (Measurement Terminal)	
9.4	Withstanding Voltage (Measurement Terminal)	
9.5	Biased Humidity (Supply Terminal)	
9.6	Operational Life (Supply Terminal)	

10. Impedance Frequency Characteristics (Typical)

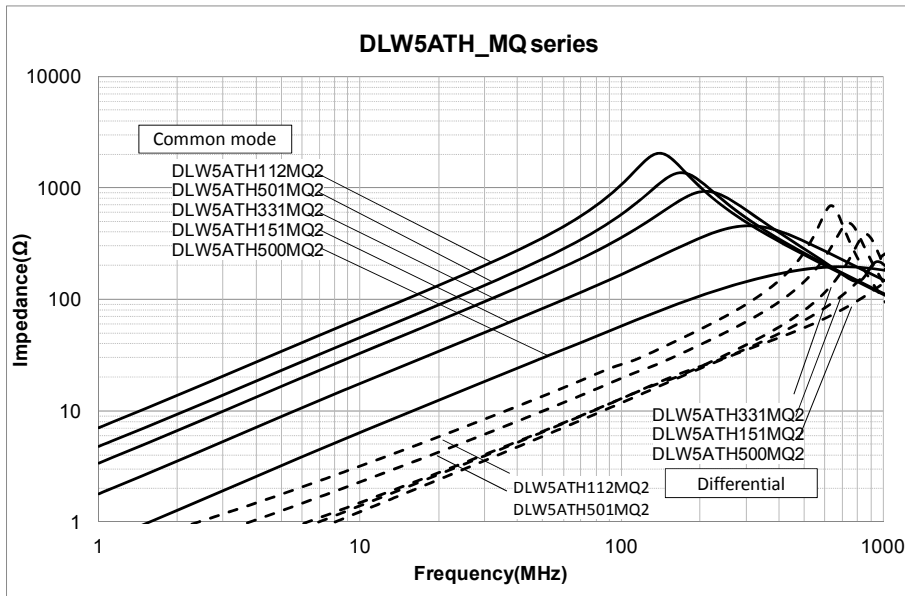

11. P.C.B., Flux, Solder and Soldering condition

Test shall be done using P.C.B., Flux, Solder and Soldering condition which are specified in item 14 except the case of being specified special condition.

12. Specification of Packaging

12.1 Appearance and Dimensions

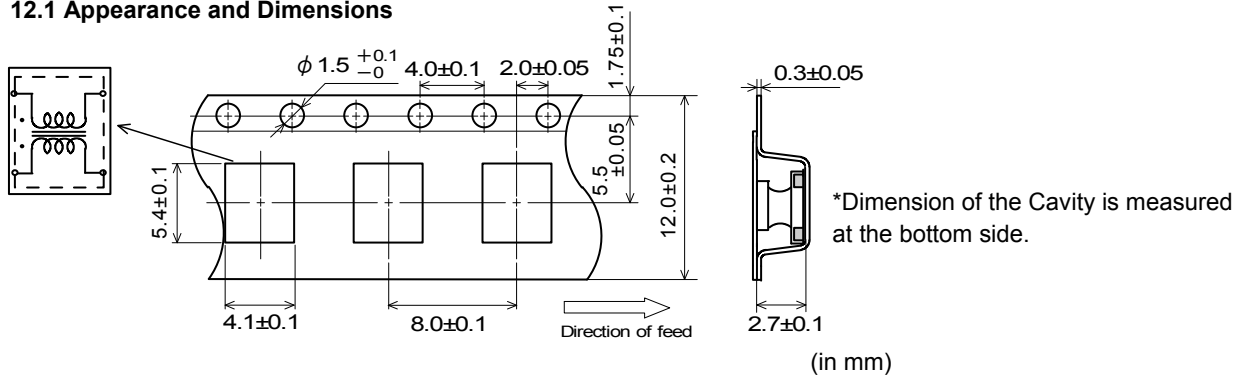

12.2 Specification of Taping

- (1) Packing quantity (Standard quantity) ϕ · 180 mm reel : 700 pcs. / reel ϕ 330 mm reel : 2500 pcs. / reel
- (2) Packing Method
Products shall be packaged in each embossed cavity of plastic tape and sealed with cover tape.
- (3) Sprocket Hole
The sprocket holes are to the right as the tape is pulled toward the user.
- (4) Spliced point
The cover tape have no spliced point.
- (5) Missing components number
Missing components number within 0.1% of the number per reel or 1 pc., whichever is greater, and are not continuous. The specified quantity per reel is kept.

12.3 Pull Strength of Plastic Tape

Plastic Tape	5 N min.
Cover Tape	10 N min.

12.4 Peeling off force of Cover Tape

0.2N to 0.7N (minimum value is typical.)
Speed of Peeling off : 300 mm / min

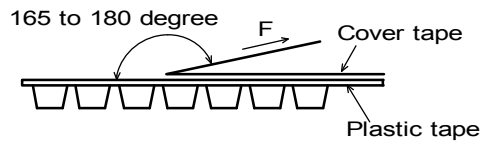

12.5 Dimensions of Leader-tape, Trailer and Reel

There shall be leader-tape (cover tape only and empty tape) and trailer-tape (empty tape) as follows.

« Packaging Code : L (ϕ 180mm reel) »

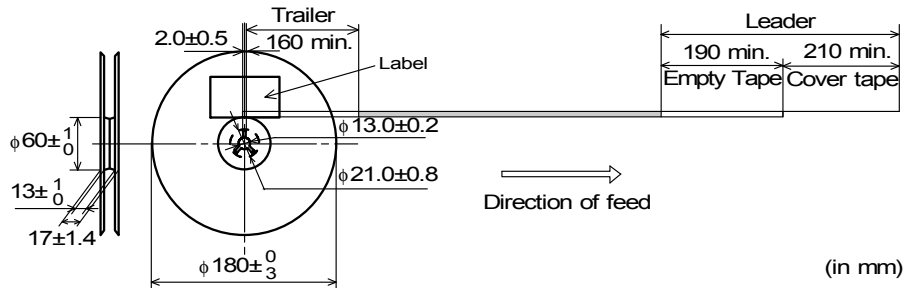

« Packaging Code : K (ϕ 330mm reel) »

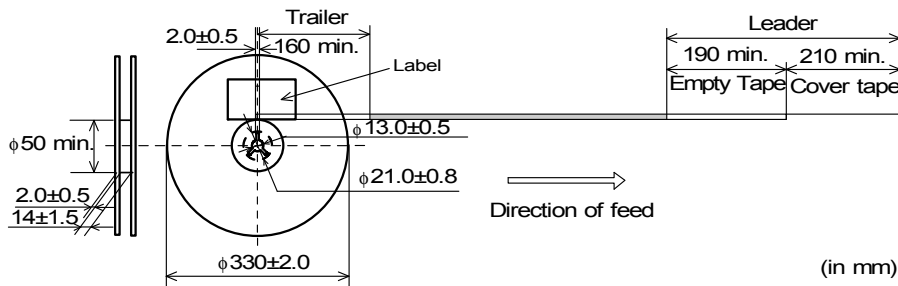

Reference Only

12.6 Marking for reel

Customer part number, MURATA part number, Inspection number(*1), RoHS marking(*2), Quantity, etc

*1) « Expression of Inspection No. » □□ 0000 XXX
(1) (2) (3)

(1) Factory Code
(2) Date

First digit : Year / Last digit of year
Second digit : Month / Jan. to Sep. → 1 to 9, Oct. to Dec. → O,N,D
Third, Fourth digit : Day

(3) Serial No.

*2) « Expression of RoHS marking » ROHS - Y (Δ)
(1) (2)

(1) RoHS regulation conformity parts.
(2) MURATA classification number

12.7 Marking for Outside package

Customer name Purchasing Order Number, Customer Part Number, MURATA part number, RoHS marking(*2), Quantity, etc

12.8 Specification of Outer Case

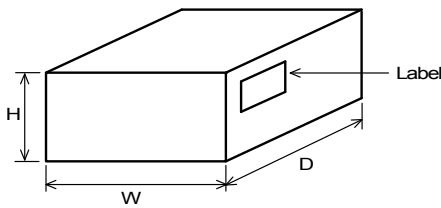

Reel	Outer Case Dimensions (mm)			Standard Reel Quantity in Outer Case (Reel)
	W	D	H	
φ 180mm	186	186	93	4
φ 330mm	340	340	85	4

* Above Outer Case size is typical. It depends on a quantity of an order.

13. Caution

13.1 Mounting Direction

Mount products in right direction.

Wrong direction which is 90 ° rotated from right direction cause not open or short circuit but also flames or other serious trouble.

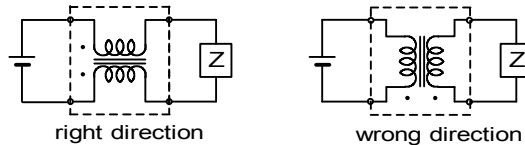

13.2 Limitation of Applications

Please contact us before using our products for the applications listed below which require especially high reliability for the prevention of defects which might directly cause damage to the third party's life, body or property.

- (1) Aircraft equipment
- (2) Aerospace equipment
- (3) Undersea equipment
- (4) Power plant control equipment
- (5) Medical equipment
- (6) Transportation equipment (trains, ships, etc.)
- (7) Traffic signal equipment
- (8) Disaster prevention / crime prevention equipment
- (9) Data-processing equipment
- (10) Applications of similar complexity and / or reliability requirements to the applications listed in the above.

13.3 Caution(Rating)

Do not exceed maximum rated current of the product. Thermal stress may be transmitted to the product and short/open circuit of the product or falling off the product may be occurred.

13.4 Fail-safe

Be sure to provide an appropriate fail-safe function on your product to prevent a second damage that may be caused by the abnormal function or the failure of our product.

14. Notice

This product is designed for solder mounting.
Please consult us in advance for applying other mounting method such as conductive adhesive.

14.1 Flux and Solder

Flux	Use rosin-based flux,(with converting chlorine content 0.06 to 0.1(wt)%), but not highly acidic flux (with Halogen content exceeding 0.2(wt)% conversion to chlorine). Do not use water-soluble flux.
Solder	Use Sn-3.0Ag-0.5Cu solder

14.2 Assembling

Products can be applied to reflow and flow soldering.

< Thermal Shock >

Pre-heating should be in such a way that the temperature difference between solder and ceramic surface is limited to 100°C max. Also cooling into solvent after soldering should be in such a way that the temperature difference is limited to 100°C max.
Not enough preheating may cause deterioration in insulation resistance and / or crank or ceramic body.

14.3 Cleaning Conditions

Products shall be cleaned on the following conditions.

- (1) Cleaning temperature shall be limited to 60°C max. (40°C max. for IPA.)
- (2) Ultrasonic cleaning shall comply with the following conditions, avoiding the resonance phenomenon at the mounted products and P.C.B.

Power:20W/ l max. Frequency:28kHz to 40kHz Time:5 min max.

(3) Cleaner

1. Cleaner
 - Isopropyl alcohol (IPA)
- 2.Aqueous agent
 - PINE ALPHA ST-100S

(4) There shall be no residual flux and residual cleaner after cleaning.

In the case of using aqueous agent, products shall be dried completely after rinse with de-ionized water in order to remove the cleaner.

(5) Other cleaning

Please contact us.

14.4 Resin coating

The impedance value may change due to high cure-stress of resin to be used for coating/molding products. An open circuit issue may occur by mechanical stress caused by the resin, amount/cured shape of resin, or operating condition etc. Some resin contains some impurities or chloride possible to generate chlorine by hydrolysis under some operating condition may cause corrosion of wire of coil, leading to open circuit. So, please pay your careful attention when you select resin in case of coating/molding the products with the resin. Prior to use the coating resin, please make sure no reliability issue is observed by evaluating products mounted on your board.

14.5 Attention regarding P.C.B. bending

The following shall be considered when designing and laying out P.C.B.'s.

- (1) P.C.B. shall be designed so that products are not subject to the mechanical stress due to warping the board.

[Products direction]

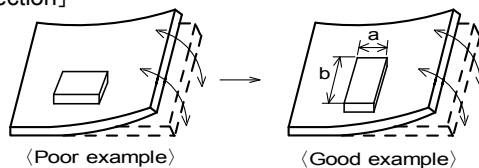

Products shall be location the sideways direction (Length:a<b) to the mechanical stress.

(2) Components location on P.C.B. separation.

It is effective to implement the following measures, to reduce stress in separating the board.

It is best to implement all of the following three measures; however, implement as many measures as possible to reduce stress.

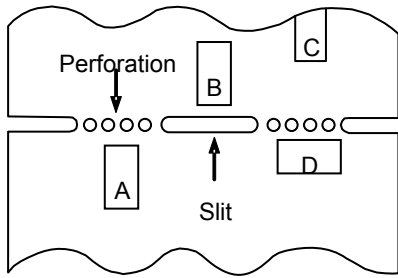

*1 $A > D$ is valid when stress is added vertically to the perforation as with Hand Separation. If a Cutting Disc is used, stress will be diagonal to the PCB, therefore $A > D$ is invalid.

(3) Mounting Components Near Screw Holes

When a component is mounted near a screw hole, it may be affected by the board deflection that occurs during the tightening of the screw. Mount the component in a position as far away from the screw holes as possible.

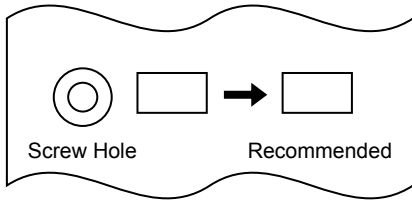

14.6 Attention Regarding P.C.B. Design

< The Arrangement of Products >

- P.C.B. shall be designed so that products are far from the portion of perforation.
- The portion of perforation shall be designed as narrow as possible, and shall be designed so as not to be applied the stress in the case of P.C.B. separation.

- Products shall not be arranged on the line of a series of holes when there are big holes in P.C.B. (Because the stress concentrate on the line of holes.)

< Products Placing >

- Support pins shall be set under P.C.B. to prevent causing a warp to P.C.B. during placing the products on the other side of P.C.B..

< P.C.B. Separation >

- P.C.B. shall not be separated with hand.
- P.C.B. shall be separated with the fixture so as not to cause P.C.B. bending.

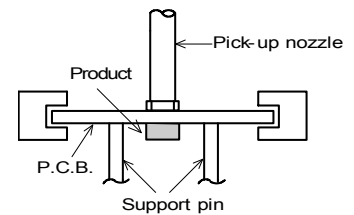
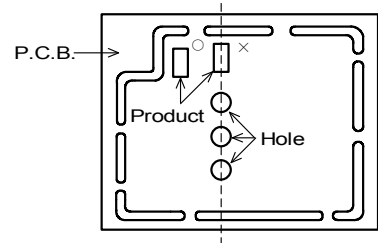
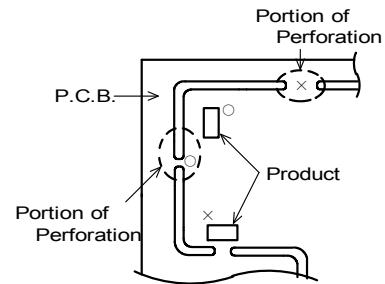

14.7 Standard Land Dimensions

<Reflow>

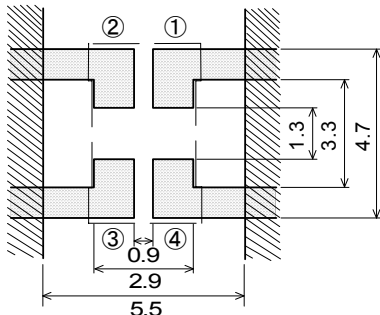

*①②③④ indicates terminal number.

- Resist
- Copper foil pattern
- No pattern

(in mm)

<Flow>

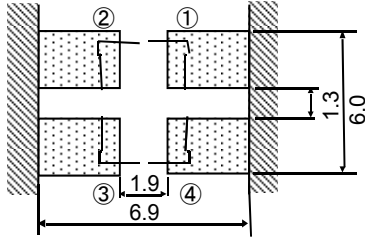

14.8 Solder paste printing for reflow

- Standard thickness of solder paste should be 150 to 200 μ m. Solderability is subject to reflow condition and thermal conductivity. Please make sure that your product has been evaluated in view of your specifications with our product being mounted to your product.
- Use the solder paste printing pattern of the right pattern.
- For the resist and copper foil pattern, use standard land dimensions.
- Use the Solder Sn-3.0Ag-0.5Cu for pattern printing.

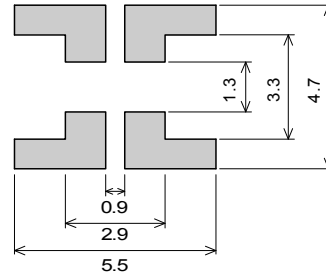

(2) Soldering Conditions

Standard soldering profile and the limit soldering profile is as follows.

The excessive soldering conditions may cause leaching of the electrode and/or resulting in the deterioration of product quality.

<Reflow>

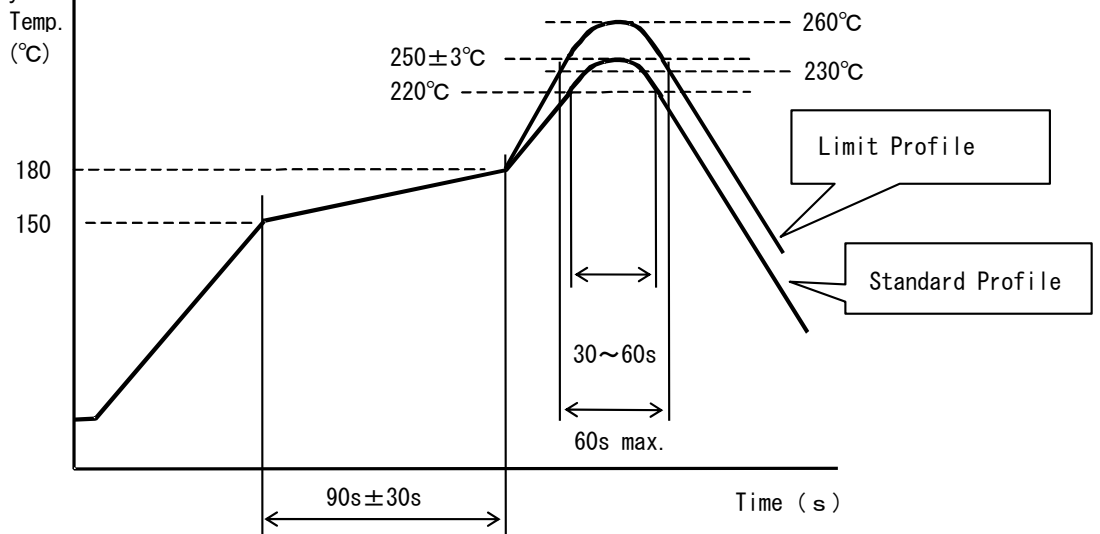

	Standard Profile	Limit Profile
Pre-heating	150~180°C、90s±30s	
Heating	above 220°C、30s~60s	above 230°C、60s max.
Peak temperature	250±3°C	260°C, 10s
Cycle of reflow	2 times	2 times

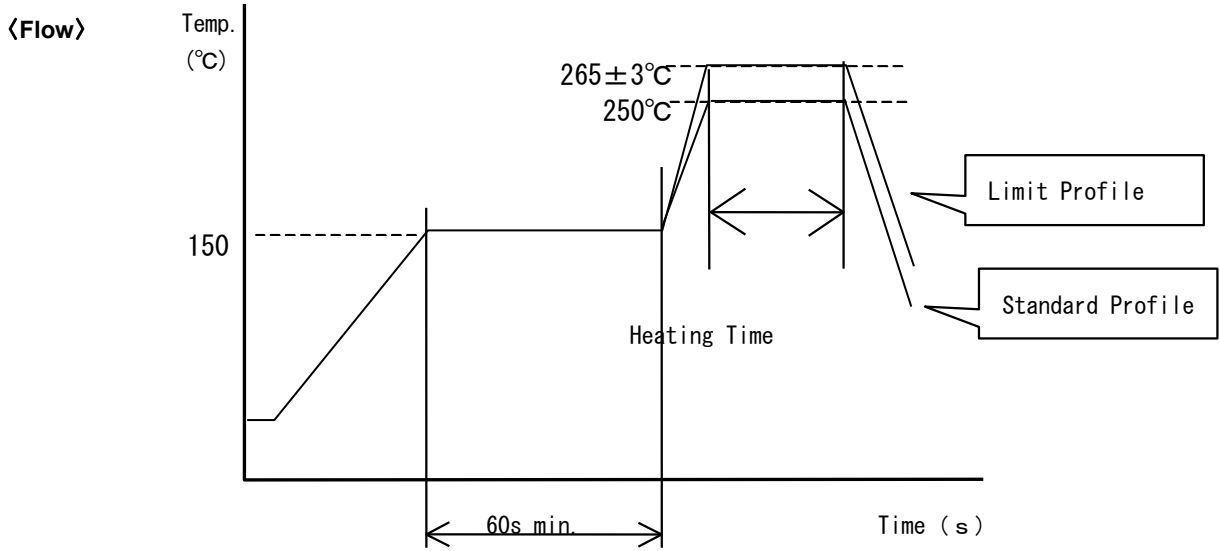

	Standard Profile	Limit Profile
Pre-heating	150°C, 60s min.	
Heating	250°C, 4~6s	265±3°C, 5s max.
Cycle of flow	2 times	2 times

(3) Printing of Adhesive (Flow Soldering)

Adhesive amount should be around 0.5mg /a chip.

- To get enough bonding strength
- To avoid spreading of adhesive onto a land. Because soldering failure may be caused by adhesive on the land.

The adhesive position is as follows.

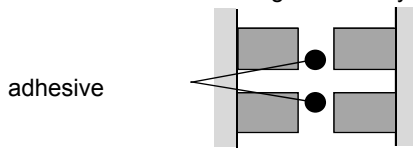

14.9 Reworking with Soldering iron

The following conditions must be strictly followed when using a soldering iron after being mounted by reflow soldering.

- Pre-heating: 150°C, 1 min
- Soldering iron output: 30W max.
- Tip temperature: 350°C max.
- Tip diameter: φ3mm max.
- Soldering time : 3(+1,-0) seconds.
- Times : 2times max.

Notes: Do not touch the products directly with the soldering iron.

14.10 Handling of a substrate

After mounting products on a substrate, do not apply any stress to the product caused by bending or twisting to the substrate when cropping the substrate, inserting and removing a connector from the substrate or tightening screw to the substrate.

Excessive mechanical stress may cause cracking in the product.

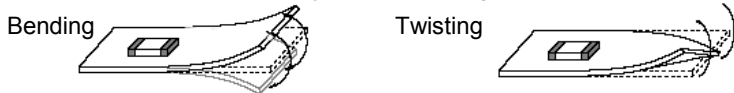

14.11 Brushing of neighborhood of products

When you clean the neighborhood of products such as connector pins, bristles of cleaning brush shall not be touched to the winding portion to prevent the breaking of wire.

14.12 Operating Environment

Do not use this product under the following environmental conditions, on deterioration of the performance, such as insulation resistance may result from the use.

- (1) in corrosive gases (acidic gases, alkaline gases, chlorine, sulfur gases, organic gases and etc.)
- (2) in the atmosphere where liquid such as organic solvent, may splash on the products.

14.13 Storage condition

(1) Storage period

Use the products within 12 months after delivered.

Solderability should be checked if this period is exceeded.

(2) Storage environment conditions

· Products should be stored in the warehouse on the following conditions.

Temperature : -10 °C to +40 °C

Humidity : 15 % to 85% relative humidity No rapid change on temperature and humidity.

· Products should not be stored in corrosive gases, such as sulfurous, acid gases, alkaline gases, to prevent the following deterioration.

Poor solderability due to the oxidized electrode.

· Products should be stored on the palette for the prevention of the influence from humidity, dust and so on.

· Products should be stored in the warehouse without heat shock, vibration, direct sunlight and so on.

· Products should not be stored under the air tight packaged condition.

(3) Delivery

Care should be taken when transporting or handling product to avoid excessive vibration or mechanical shock.

15. Note

(1) Please make sure that your product has been evaluated in view of your specifications with our product being mounted to your product.

(2) You are requested not to use our product deviating from the reference specifications.

(3) The contents of this reference specification are subject to change without advance notice. Please approve our product specifications or transact the approval sheet for product specifications before ordering.