

## DM74ALS138 3 to 8 Line Decoder/Demultiplexer

### General Description

These Schottky-clamped circuits are designed to be used in high-performance memory-decoding or data-routing applications, requiring very short propagation delay times. In high-performance memory systems these decoders can be used to minimize the effects of system decoding. When used with high-speed memories, the delay times of these decoders are usually less than the typical access time of the memory. This means that the effective system delay introduced by the decoder is negligible.

The ALS138 decodes one-of-eight lines, based upon the conditions at the three binary select inputs and the three enable inputs. Two active-low and one active-high enable inputs reduce the need for external gates or inverters when expanding. A 24-line decoder can be implemented with no external inverters, and 32-line decoder requires only one inverter. An enable input can be used as a data input for demultiplexing applications.

This decoder/demultiplexer features fully buffered inputs, presenting only one normalized load to its driving circuit. All inputs are clamped with high-performance Schottky diodes to suppress line-ringing and simplify system design.

### Features

- Designed specifically for high speed:
  - Memory decoders
  - Data transmission systems
- 3- to 8-line decoder incorporates 3 enable inputs to simplify cascading and/or data reception
- Low power dissipation . . . 23 mW typ
- Switching specifications guaranteed over full temperature and  $V_{CC}$  range
- Advanced oxide-isolated, ion-implanted Schottky TTL process

### Connection Diagram

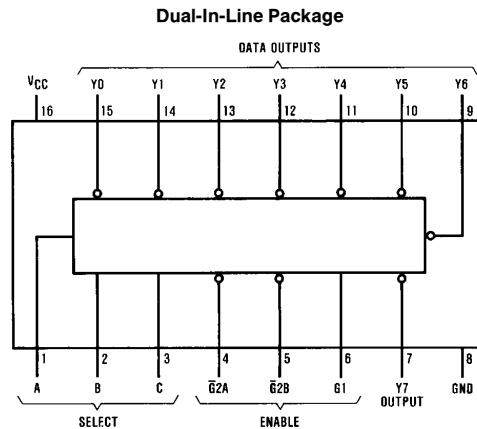

TL/F/6111-1

Order Number DM74ALS138M, DM74ALS138N or DM74ALS138J  
See NS Package Number M16A, M16D or N16A

## Absolute Maximum Ratings

Supply Voltage	7V
Input Voltage	7V
Operating Free Air Temperature Range	
DM74ALS	0°C to +70°C
Storage Temperature Range	-65°C to +150°C
Typical $\theta_{JA}$	
N Package	75.5°C/W
M Package	104.0°C/W

Note: The "Absolute Maximum Ratings" are those values beyond which the safety of the device cannot be guaranteed. The device should not be operated at these limits. The parametric values defined in the "Electrical Characteristics" table are not guaranteed at the absolute maximum ratings. The "Recommended Operating Conditions" table will define the conditions for actual device operation.

## Recommended Operating Conditions

Symbol	Parameter	DM74ALS138			Units
		Min	Nom	Max	
$V_{CC}$	Supply Voltage	4.5	5	5.5	V
$V_{IH}$	High Level Input Voltage	2			V
$V_{IL}$	Low Level Input Voltage			0.8	V
$I_{OH}$	High Level Output Current			-0.4	mA
$I_{OL}$	Low Level Output Current			8	mA
$T_A$	Free Air Operating Temperature	0		70	°C

## Electrical Characteristics

over recommended operating free air temperature range. All typical values are measured at  $V_{CC} = 5V$ ,  $T_A = 25^\circ C$ .

Symbol	Parameter	Conditions	Min	Typ	Max	Units
$V_{IK}$	Input Clamp Voltage	$V_{CC} = 4.5V$ , $I_I = -18\text{ mA}$			-1.5	V
$V_{OH}$	High Level Output Voltage	$I_{OH} = -0.4\text{ mA}$ $V_{CC} = 4.5V\text{ to }5.5V$	$V_{CC} - 2$			V
$V_{OL}$	Low Level Output Voltage	$V_{CC} = 4.5V$ 74ALS $I_{OL} = 8\text{ mA}$		0.35	0.5	V
$I_I$	Input Current @ Max. Input Voltage	$V_{CC} = 5.5V$ , $V_{IH} = 7V$			0.1	mA
$I_{IH}$	High Level Input Current	$V_{CC} = 5.5V$ , $V_{IH} = 2.7V$			20	$\mu A$
$I_{IL}$	Low Level Input Current	$V_{CC} = 5.5V$ , $V_{IL} = 0.4V$			-0.1	mA
$I_O$	Output Drive Current	$V_{CC} = 5.5V$ $V_O = 2.25V$	-30		-112	mA
$I_{CC}$	Supply Current	$V_{CC} = 5.5V$		5	10	mA

## Switching Characteristics

over recommended operating free air temperature range (Note 1).

Symbol	Parameter	Conditions	From (Input) To (Output)	DM74ALS138		Units
				Min	Max	
$t_{PLH}$	Propagation Delay Time Low to High Level Output	$V_{CC} = 4.5V\text{ to }5.5V$ $R_L = 500\Omega$ $C_L = 50\text{ pF}$	A, B, C to Y	6	22	ns
$t_{PHL}$	Propagation Delay Time High to Low Level Output		A, B, C to Y	6	18	ns
$t_{PLH}$	Propagation Delay Time Low to High Level Output		Enable to Y	4	17	ns
$t_{PHL}$	Propagation Delay Time High to Low Level Output		Enable to Y	5	17	ns

Note 1: See Section 5 for test waveforms and output load.

## Function Table

Enable Inputs		Select Inputs			Outputs							
G1	$\overline{G2}^*$	C	B	A	Y0	Y1	Y2	Y3	Y4	Y5	Y6	Y7
X	H	X	X	X	H	H	H	H	H	H	H	H
L	X	X	X	X	H	H	H	H	H	H	H	H
H	L	L	L	L	L	H	H	H	H	H	H	H
H	L	L	L	H	H	L	H	H	H	H	H	H
H	L	L	H	L	H	H	L	H	H	H	H	H
H	L	L	H	H	H	H	L	H	H	H	H	H
H	L	H	L	L	H	H	H	H	L	H	H	H
H	L	H	L	H	H	H	H	H	H	L	H	H
H	L	H	H	L	H	H	H	H	H	H	L	H
H	L	H	H	H	H	H	H	H	H	H	H	L

\* $\overline{G2} = \overline{G2A} + \overline{G2B}$

## Logic Diagram

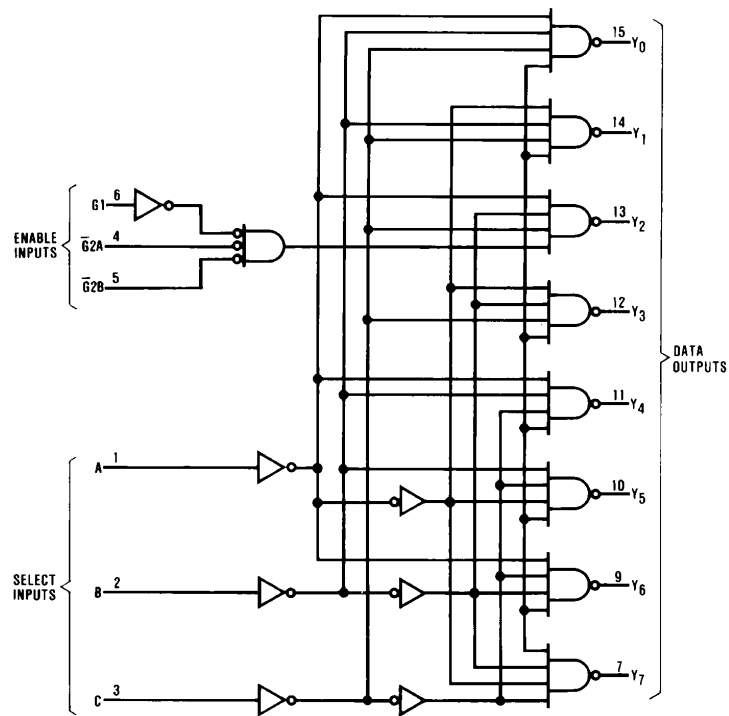

TL/F/6111-2



**Physical Dimensions** inches (millimeters)

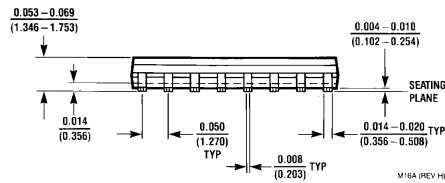
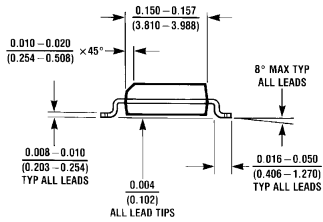
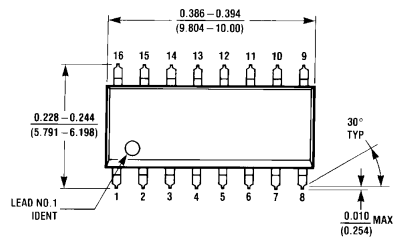

**Small Outline Package (M)**  
**Order Number DM74ALS138M**  
**NS Package Number M16A**

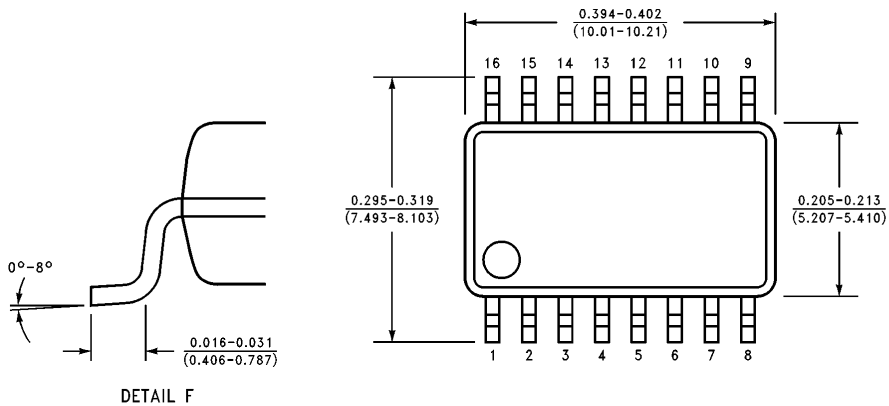

DETAIL F

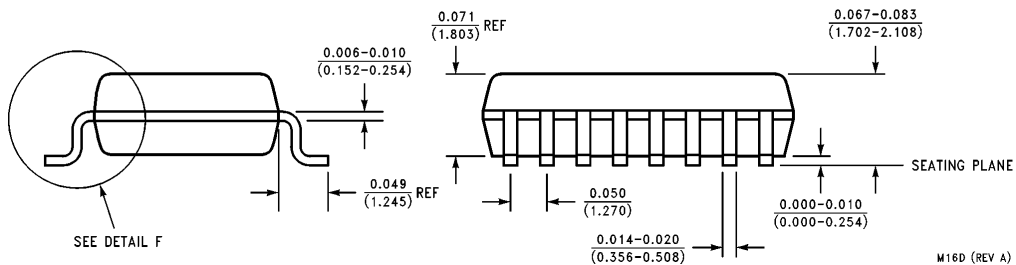

SEE DETAIL F

**Small Outline Package (SJ)**  
**Order Number DM74ALS138SJ**  
**NS Package Number M16D**

M16D (REV A)

DM74ALS138 3 to 8 Line Decoder/Demultiplexer

**Physical Dimensions** inches (millimeters) (Continued)

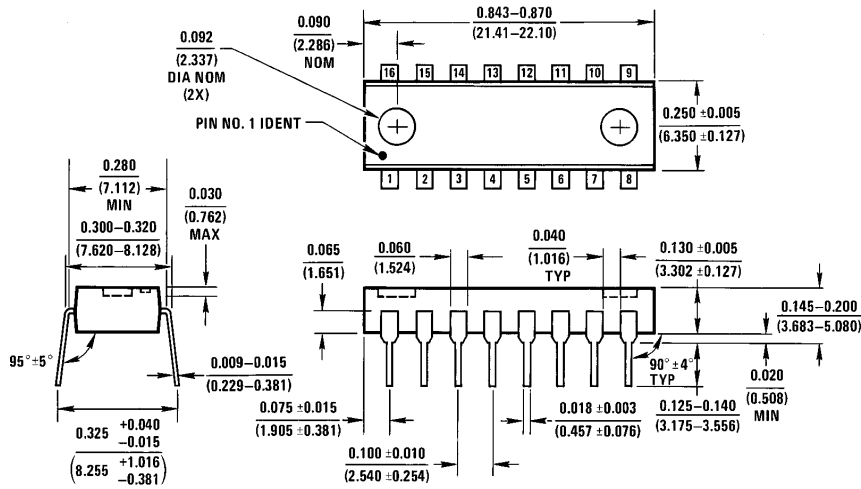

**Molded Dual-In-Line Package (N)**  
**Order Number DM74ALS138N**  
**NS Package Number N16A**

N16A (REV E)

**LIFE SUPPORT POLICY**

NATIONAL'S PRODUCTS ARE NOT AUTHORIZED FOR USE AS CRITICAL COMPONENTS IN LIFE SUPPORT DEVICES OR SYSTEMS WITHOUT THE EXPRESS WRITTEN APPROVAL OF THE PRESIDENT OF NATIONAL SEMICONDUCTOR CORPORATION. As used herein:

1. Life support devices or systems are devices or systems which, (a) are intended for surgical implant into the body, or (b) support or sustain life, and whose failure to perform, when properly used in accordance with instructions for use provided in the labeling, can be reasonably expected to result in a significant injury to the user.
2. A critical component is any component of a life support device or system whose failure to perform can be reasonably expected to cause the failure of the life support device or system, or to affect its safety or effectiveness.



**National Semiconductor Corporation**  
 1111 West Bardin Road  
 Arlington, TX 76017  
 Tel: 1(800) 272-9959  
 Fax: 1(800) 737-7018

**National Semiconductor Europe**  
 Fax: (+49) 0-180-530 85 86  
 Email: cnjwge@tevm2.nsc.com  
 Deutsch Tel: (+49) 0-180-530 85 85  
 English Tel: (+49) 0-180-532 78 32  
 Français Tel: (+49) 0-180-532 93 58  
 Italiano Tel: (+49) 0-180-534 16 80

**National Semiconductor Hong Kong Ltd.**  
 19th Floor, Straight Block,  
 Ocean Centre, 5 Canton Rd.  
 Tsimshatsui, Kowloon  
 Hong Kong  
 Tel: (852) 2737-1600  
 Fax: (852) 2736-9960

**National Semiconductor Japan Ltd.**  
 Tel: 81-043-299-2309  
 Fax: 81-043-299-2408

National does not assume any responsibility for use of any circuitry described, no circuit patent licenses are implied and National reserves the right at any time without notice to change said circuitry and specifications.