

Am78/8830

Dual Differential Line Driver

Distinctive Characteristics

- Single 5-volt power supply
- Input diodes for prevention of line ringing
- Low output skew between NAND and AND propagation delays.
- Clamped outputs for reduction in positive and negative voltage transients.
- 100% reliability assurance testing in compliance with MIL-STD-883.

FUNCTIONAL DESCRIPTION

The Am78/8830 is a dual differential line driver suitable for driving differential lines with characteristic impedances in the range 50Ω to 500Ω.

Each driver consists of a 4-input AND gate in parallel with a 4-input NAND gate. The inputs to the gates are clamped to reduce the effect of line transients. The differential outputs are balanced and have approximately the same delay so as to minimize skew problems, and have high drive capability at both the LOW and HIGH levels.

The device is ideal for driving differential transmission lines, and forms a very noise insensitive balanced digital communication system with excellent common mode noise rejection when used in conjunction with the Am78/8820A dual differential receiver.

LOGIC DIAGRAM

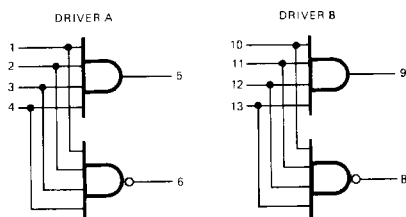

V_{CC} = Pin 14
GND = Pin 7

LIC-524

CIRCUIT DIAGRAM

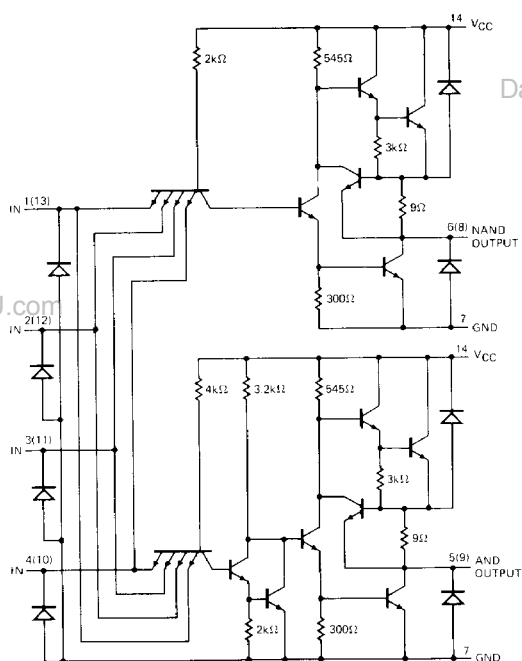

Note: Only one driver shown

LIC-525

Am78/8830 ORDERING INFORMATION

Package Type	Temperature Range	Order Number
Molded DIP	0°C to +75°C	DM8830N
Ceramic DIP	0°C to +75°C	DM8830J
Hermetic DIP	-55°C to +125°C	DM7830J
Hermetic Flat Pak	-55°C to +125°C	DM7830W
Dice	0°C to +75°C	AM8830X
Dice	-55°C to +125°C	AM7830X

CONNECTION DIAGRAM Top View

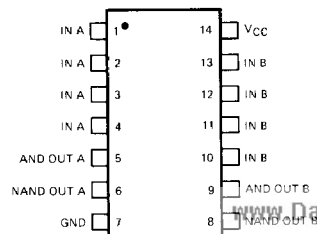

Note: Pin 1 is marked for orientation

LIC-526

Am78/8830**MAXIMUM RATINGS** (Above which the useful life may be impaired)

Storage Temperature	-65°C to +150°C
Temperature (Ambient) Under Bias	-55°C to +125°C
Supply Voltage to Ground Potential (Pin 16 to Pin 8) Continuous	-0.5V to +7V
DC Voltage Applied to Outputs for HIGH Output State	-0.5V to +V _{CC} max.
DC Input Voltage	-0.5V to +5.5V
Output Current, Into Outputs	100mA
DC Input Current	-30mA to +5.0mA
Output Short Circuit Duration at 125°C	1sec

ELECTRICAL CHARACTERISTICS OVER OPERATING TEMPERATURE RANGE (Unless Otherwise Noted)

Am8830 T_A = 0°C to +75°C V_{CC} = 5.0V ±5%
 Am7830 T_A = -55°C to +125°C V_{CC} = 5.0V ±10%

Parameters	Description	Test Conditions	Min.	Typ. (Note 1)	Max.	Units	
V _{OH}	Output HIGH Voltage	V _{CC} = MIN., V _{IN} = 0.8V	I _{OH} = -40mA	1.8	2.9		Volts
			I _{OH} = -0.8mA	2.4	3.3		
V _{OL}	Output LOW Voltage	V _{CC} = MIN., V _{IN} = 0.8V	I _{OL} = 40mA		0.22	0.5	Volts
			I _{OL} = 32mA		0.2	0.4	
V _{IH}	Input HIGH Level Voltage	Guaranteed input logical HIGH voltage for all inputs	2.0			Volts	
V _{IL}	Input LOW Level Voltage	Guaranteed input logical LOW voltage for all inputs			0.8	Volts	
I _{IL}	Input LOW Current	V _{CC} = MAX., V _{IN} = 0.4V		-3.0	-4.8	mA	
I _{IH}	Input HIGH Current	V _{CC} = MAX., V _{IN} = 2.4V			120	μA	
	Input HIGH Current	V _{CC} = MAX., V _{IN} = 5.5V			2.0	mA	
I _{SC} (Note 2)	Output Short Circuit Current	V _{CC} = 5.0V, V _{OUT} = 0.0V	-40	-100	-120	mA	
I _{CC}	Power Supply Current*	V _{CC} = MAX. (Each Driver)		11	18	mA	

Note 1. Typical limits are at V_{CC} = 5.0V, 25°C ambient and maximum loading.

Note 2. Limits for T_A = +125°C only.

Switching Characteristics (T_A = 25°C)

Parameters	Description	Conditions	Min.	Typ.	Max.	Units
t _{PLH}	Delay from Inputs to Output of AND Gate	V _{CC} = 5.0V, C _L = 15pF See Figure 1		8	12	ns
t _{PHL}				11	18	ns
t _{PLH}	Delay from Inputs to Output of NAND gate			8	12	ns
t _{PHL}				5	8	ns
t ₁	Differential Delay	V _{CC} = 5.0V, C _L = 5000pF R _L = 100Ω, See Figure 2		12	16	ns
t ₂				12	16	ns

SWITCHING TIME WAVEFORMS AND AC TEST CIRCUIT

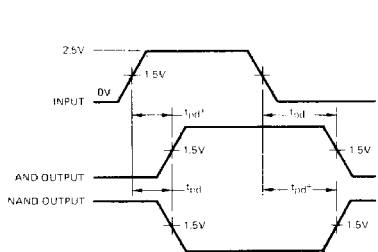

LIC-527

Figure 1.

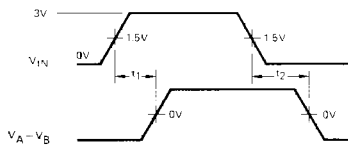

LIC-528

Figure 2.

LIC-529

TYPICAL ELECTRICAL CHARACTERISTICS

Output High Voltage Versus Output Current

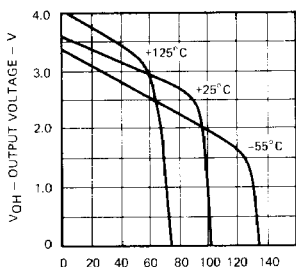

I_{OH} - OUTPUT SOURCE CURRENT - mA

Differential Delay Versus Temperature

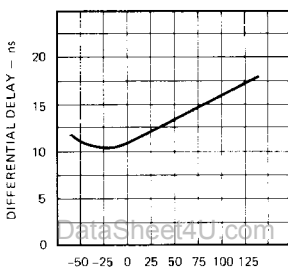

T_A - TEMPERATURE - °C

Threshold Voltage Versus Temperature

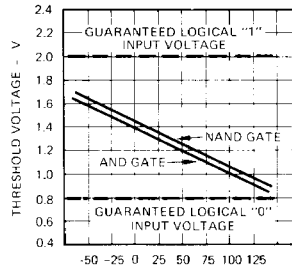

T_A - TEMPERATURE - °C

Differential Output Voltage VAND - VNAND Versus Differential Output Current

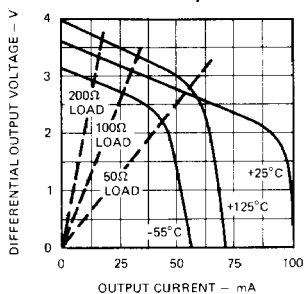

Power Dissipation (No Load) Versus Data Input Frequency

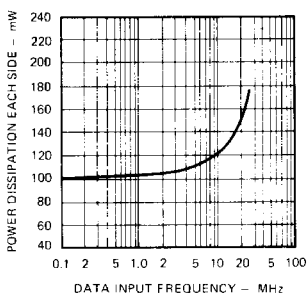

Maximum Power Dissipation

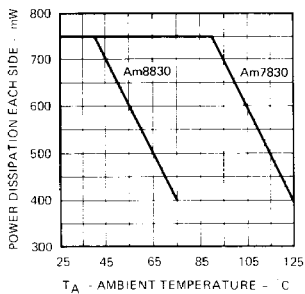

Output Low Voltage Versus Output Current

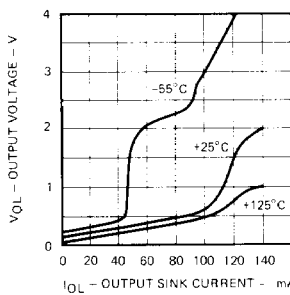

LIC-530

APPLICATIONS

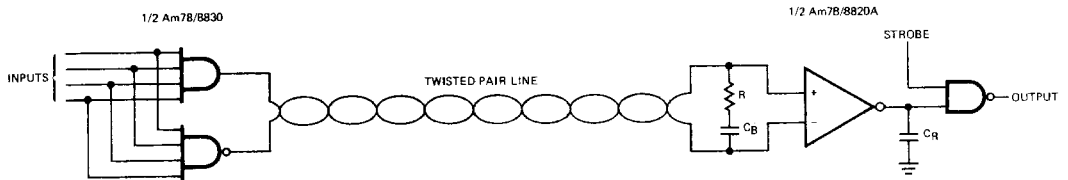

LIC-531

TYPICAL TWISTED PAIR DIFFERENTIAL COMMUNICATION SYSTEM

The Am78/8830 drives a twisted pair line which is terminated at the receiving end by an RC network. The R is approximately equal to the line impedance (170Ω) and is part of the Am78/8820A differential receiver. The C_B is a blocking capacitor which stops DC current flow, and for low duty cycles reduces power consumption. The value of this capacitor depends upon the data rate, C_B must be large compared to $\frac{1}{f_d R}$ where f_d is the data rate. The capacitor C_R is used to control the response time of the receiver and limit high frequency noise. $C_R \sim 4 \times 10^3 \frac{1}{f_n}$ where C is in pF and f_n is the lowest noise frequency expected in MHz.

DataSheet4U.com

Metallization and Pad Layout

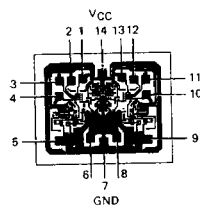

DIE SIZE 0.050" x 0.063"

www.DataSheet4U.com