

<div style="border: 1px solid black; border-radius: 15px; padding: 5px; display: inline-block;"> <h2 style="margin: 0;">LCD Module Specification</h2> </div>	First Edition	Approved by	Production Div.
	Jul 12, 1999	Checked by	Quality Assurance Div.
	Final Revision	Checked by	Design Engineering Div.
	*****	Prepared by	Production Div.
Type No.	DMC 2 0 2 6 1 N Y - L Y - A X E		

Table of Contents

1. General Specifications	2
2. Electrical Specifications.....	3
3. Optical Specifications	6
4. I/O Terminal	8
5. Test.....	10
6. Appearance Standards.....	11
7. Code System of Production Lot	14
8. Type Number.....	14
9. Applying Precautions	14
10. Precautions Relating Product Handling.....	15
11. Warranty.....	16

Revision History

Rev.	Date	Page	Comment



1. General Specifications

Operating Temp.	: min. 0°C ~ max. 50°C
Storage Temp.	: min. -20°C ~ max. 70°C
Display Format	: 20 characters × 2 lines
Display Fonts	: 5 × 8 dots (1 character)
Viewing Area	: 83.0 (W) × 18.6 (H) mm
Outline Dimensions	: 116.0 (W) × 37.0 (H) × 15.7 max. (D) mm
Weight	: 90g max.
LCD Type	: NTD-7057 (STN / Yellow-mode / Transmissive)
Viewing Angle	: 6:00
Backlight	: LED Backlight / Yellow-green
Drawings	: Dimensional Outline UE-301030

2. Electrical Specifications

2.1. Absolute Maximum Ratings

V_{SS}=0V

Parameter	Symbol	Conditions	Min.	Max.	Units
Supply Voltage (Logic)	V _{DD} -V _{SS}	—	-0.3	7.0	V
Supply Voltage (LCD Drive)	V _{DD} -V _{EE}	—	0	13.0	V
Input Voltage	V _I	—	-0.3	V _{DD} +0.3	V

2.2. DC Characteristics

T_a=25°C, V_{SS}=0V

Parameter	Symbol	Conditions	Min.	Typ.	Max.	Units
Supply Voltage (Logic)	V _{DD} -V _{SS}	—	4.5	—	5.5	V
Supply Voltage (LCD Drive)	V _{DD} -V _{EE}	Shown in 3.1				V
High Level Input Voltage	V _{IH}	V _{DD} =5.0V ± 10%	2.2	—	V _{DD}	V
Low Level Input Voltage	V _{IL}	V _{DD} =5.0V ± 10%	-0.3	—	0.6	V
High Level Output Voltage	V _{OH}	I _{OH} =-0.205mA	2.4	—	—	V
Low Level Output Voltage	V _{OL}	I _{OL} =1.2mA	—	—	0.4	V
Supply Current	I _{DD}	V _{DD} -V _{SS} =5.0V	—	1.5	3.0	mA

2.3.AC Characteristics

$V_{DD}=5.0V \pm 10\%$

Parameter	Symbol	Conditions	Min.	Max.	Units
Enable Cycle Time	t_{CYC}	Fig.1, 2	500	—	ns
Enable Pulse Width	P_{WEH}	Fig.1, 2	230	—	ns
Enable Rise/Fall Time	t_{Er}, t_{Ef}	Fig.1, 2	—	20	ns
Address Setup Time	t_{AS}	Fig.1, 2	40	—	ns
Address Hold Time	t_{AH}	Fig.1, 2	10	—	ns
Write Data Setup Time	t_{DSW}	Fig.1	80	—	ns
Write Data Hold Time	t_{DHW}	Fig.1	10	—	ns
Read Data Delay Time	t_{DDR}	Fig.2	—	160	ns
Read Data Hold Time	t_{DHR}	Fig.2	5	—	ns



Fig.1 Write Operation Timing



Fig.2 Read Operation Timing

2.4. Lighting Specifications

2.4.1. Absolute Maximum Ratings

Ta=25°C

Parameter	Symbol	Conditions	Min.	Typ.	Max.	Units
Foward Current	I _F	Note 1	—	—	260	mA
Reverse Voltage	V _R	—	—	—	8	V
LED Power Dissipation	P _D	—	—	—	1.2	W

Note 1 : Refer to the foward current derating curve.

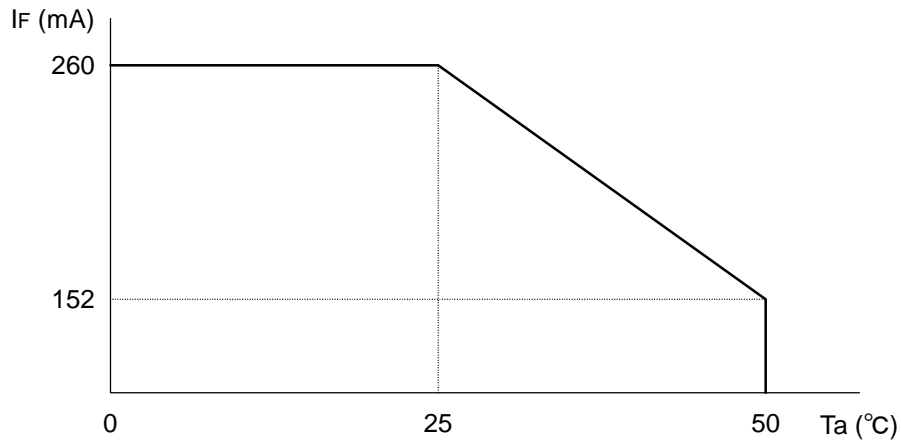

2.4.2. Operating Characteristics

Ta=25°C

Parameter	Symbol	Conditions	Min.	Typ.	Max.	Units
Foward Voltage	V _F	I _F =130mA	3.8	4.1	4.4	V
Luminance of Backlight Surface	L	I _F =130mA	40	—	—	cd/m ²

3. Optical Specifications

3.1. LCD Driving Voltage

Parameter	Symbol	Conditions	Min.	Typ.	Max.	Units
Recommended LCD Driving Voltage Note 1	$V_{DD}-V_{EE}$	Ta=0°C	—	—	5.0	V
		Ta=25°C	4.2	4.5	4.8	V
		Ta=50°C	4.0	—	—	V

Note 1 : Voltage (Applied actual waveform to LCD Module) for the best contrast. The range of minimum and maximum shows tolerance of the operating voltage. The specified contrast ratio and response time are not guaranteed over the entire range.

3.2. Optical Characteristics

Ta=25°C, 1/16 Duty, 1/4.5 Bias, $V_D=4.5V$ (Note 4), $\theta = 0^\circ$, $\phi = -^\circ$

Parameter	Symbol	Conditions	Min.	Typ.	Max.	Units	
Contrast Ratio Note 1	CR	$\theta = 0^\circ$, $\phi = -^\circ$	—	12	—		
Viewing Angle		Shown in 3.3					
Response Time	Rise Note 2	T_{ON}	—	—	130	200	ms
	Decay Note 3	T_{OFF}	—	—	180	280	ms

Note 1 : Contrast ratio is defined as follows.

$$CR = L_{OFF} / L_{ON}$$

L_{ON} : Luminance of the ON segments

L_{OFF} : Luminance of the OFF segments

Note 2 : The time that the luminance level reaches 90% of the saturation level from 0% when ON signal is applied.

Note 3 : The time that the luminance level reaches 10% of the saturation level from 100% when OFF signal is applied.

Note 4 : Definition of Driving Voltage V_D

Assuming that the typical driving waveforms shown below are applied to the LCD Panel at 1/A Duty - 1/B Bias (A : Duty Number, B : Bias Number). Driving voltage V_D is defined as follows.

$$V_D = (V_{th1} + V_{th2}) / 2$$

V_{th1} : The voltage V_{O-P} that should provide 50% of the saturation level in the luminance at the segment which the ON signal is applied to.

V_{th2} : The voltage V_{O-P} that should provide 50% of the saturation level in the luminance at the segment which the OFF signal is applied to.



3.3. Definition of Viewing Angle and Optimum Viewing Area

- Point ● shows the point where contrast ratio is measured. : $\theta = 0^\circ$, $\phi = -^\circ$
- Driving condition : 1/16 Duty, 1/4.5 Bias, $V_D=4.5V$, $f_F=84.4Hz$

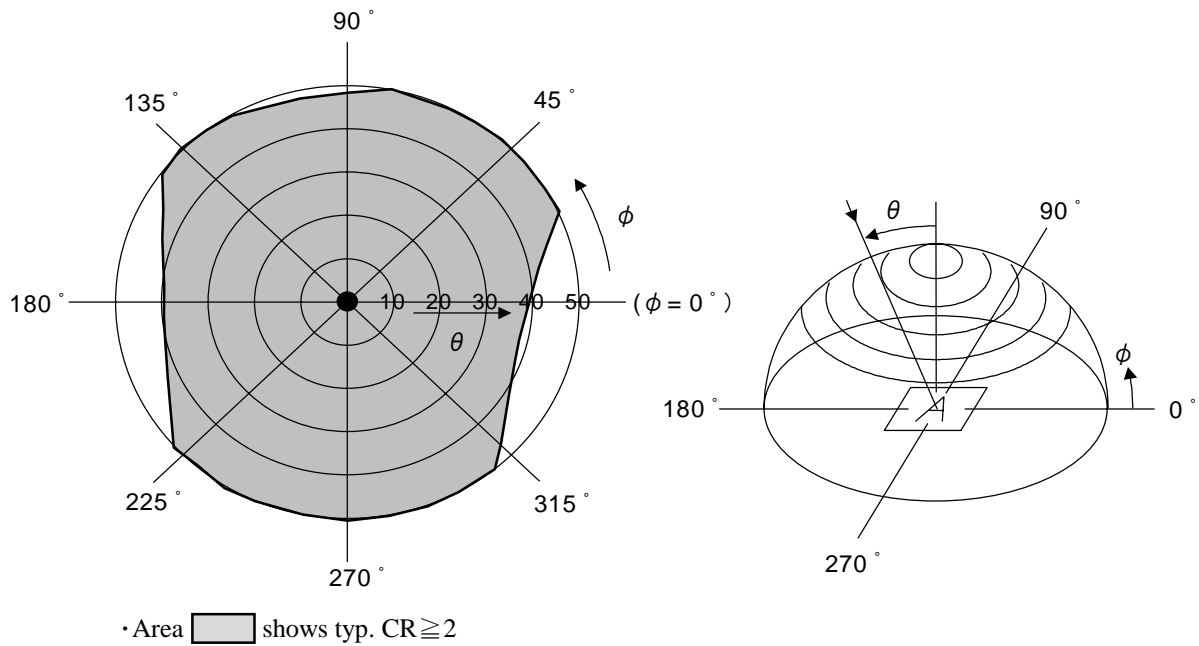

3.4. System Block Diagram

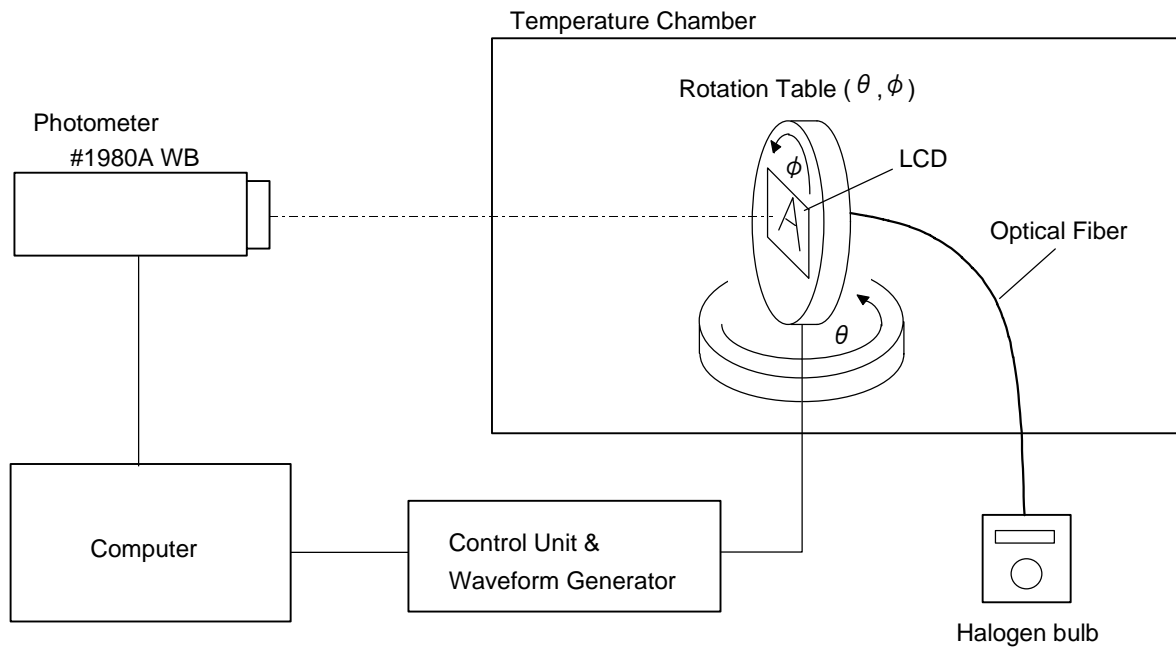

4. I/O Terminal

4.1. Pin Assignment

No.	Symbol	Level	Function
1	V _{SS}	—	Power Supply (0V, GND)
2	V _{DD}	—	Power Supply for Logic
3	V _{EE}	—	Power Supply for LCD Drive
4	RS	H / L	Register Select Signal
5	R/W	H / L	Read/Write Select Signal H : Read L : Write
6	E	H / L	Enable Signal (No pull-up Resister)
7	DB0	H / L	Data Bus Line / Non-connection at 4-bit operation
8	DB1	H / L	Data Bus Line / Non-connection at 4-bit operation
9	DB2	H / L	Data Bus Line / Non-connection at 4-bit operation
10	DB3	H / L	Data Bus Line / Non-connection at 4-bit operation
11	DB4	H / L	Data Bus Line
12	DB5	H / L	Data Bus Line
13	DB6	H / L	Data Bus Line
14	DB7	H / L	Data Bus Line
15	ANODE	—	LED Anode Terminal
16	CATHODE	—	LED Cathode Terminal

4.2. Example of Power Supply

It is recommended to apply a potentiometer for the contrast adjust due to the tolerance of the driving voltage and its temperature dependence.

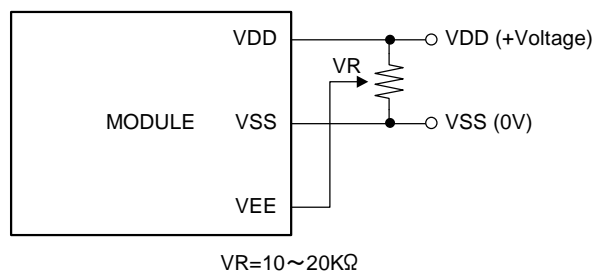

4.3. Block Diagram

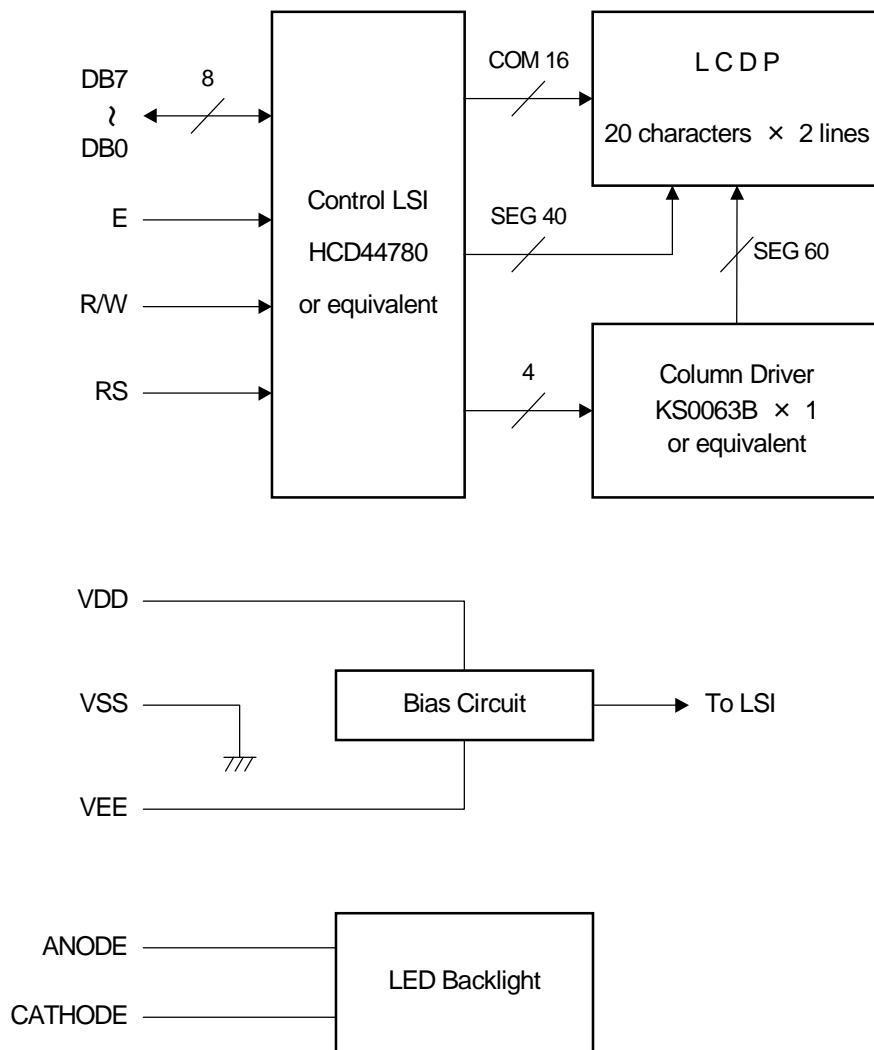

5. Test

No change on display and in operation under the following test condition.

No.	Parameter	Conditions	Notes
1	High Temperature Operating	50°C ± 2°C, 96hrs (operation state)	
2	Low Temperature Operating	0°C ± 2°C, 96hrs (operation state)	3
3	High Temperature Storage	70°C ± 2°C, 96hrs	4
4	Low Temperature Storage	-20°C ± 2°C, 96hrs	3, 4
5	Damp Proof Test	40°C ± 2°C, 90~95%RH, 96hrs	3, 4
6	Vibration Test	Total fixed amplitude : 1.5mm Vibration Frequency : 10~55Hz One cycle 60 seconds to 3 directions of X, Y, Z for each 15 minutes	5
7	Shock Test	To be measured after dropping from 60cm high on the concrete surface in packing state.  Dropping method corner dropping A corner : once Edge dropping B,C,D edge : once Face dropping E,F,G face : once	

Note 1 : Unless otherwise specified, tests will be conducted under the following condition.

Temperature : 20 ± 5°C

Humidity : 65 ± 5%

Note 2 : Unless otherwise specified, tests will be not conducted under functioning state.

Note 3 : No dew condensation to be observed.

Note 4 : The function test shall be conducted after 4 hours storage at the normal temperature and humidity after removed from the test chamber.

Note 5 : Vibration test will be conducted to the product itself without putting it in a container.

6. Appearance Standards

6.1. Inspection conditions

The LCD shall be inspected under 40W white fluorescent light.

The distance between the eyes and the sample shall be more than 30cm.

All directions for inspecting the sample should be within 45° against perpendicular line.



6.2. Definition of applicable Zones



A Zone : Active display area

B Zone : Area from outside of "A Zone" to validity viewing area

C Zone : Rest parts

A Zone + B Zone = Validity viewing area

6.3.Standards

No.	Parameter	Criteria																																																											
1	Black and White Spots, Foreign Substances	<p>(1) Round Shape</p> <table border="1" data-bbox="608 322 1369 607"> <thead> <tr> <th data-bbox="608 322 911 367">Zone</th> <th colspan="3" data-bbox="911 322 1369 367">Acceptable Number</th> </tr> <tr> <th data-bbox="608 367 911 412">Dimension (mm)</th> <th data-bbox="911 367 1062 412">A</th> <th data-bbox="1062 367 1214 412">B</th> <th data-bbox="1214 367 1369 412">C</th> </tr> </thead> <tbody> <tr> <td data-bbox="608 412 911 456">$D \leq 0.1$</td> <td data-bbox="911 412 1062 456">*</td> <td data-bbox="1062 412 1214 456">*</td> <td data-bbox="1214 412 1369 456">*</td> </tr> <tr> <td data-bbox="608 456 911 501">$0.1 < D \leq 0.2$</td> <td data-bbox="911 456 1062 501">5</td> <td data-bbox="1062 456 1214 501">5</td> <td data-bbox="1214 456 1369 501">*</td> </tr> <tr> <td data-bbox="608 501 911 546">$0.2 < D \leq 0.3$</td> <td data-bbox="911 501 1062 546">0</td> <td data-bbox="1062 501 1214 546">1</td> <td data-bbox="1214 501 1369 546">*</td> </tr> <tr> <td data-bbox="608 546 911 607">$0.3 < D$</td> <td data-bbox="911 546 1062 607">0</td> <td data-bbox="1062 546 1214 607">0</td> <td data-bbox="1214 546 1369 607">*</td> </tr> </tbody> </table> <p data-bbox="624 622 1075 651">$D = (\text{Long} + \text{Short}) / 2$ * : Disregard</p> <p>(2) Line Shape</p> <table border="1" data-bbox="608 703 1369 1039"> <thead> <tr> <th colspan="2" data-bbox="608 703 911 748">Zone</th> <th colspan="3" data-bbox="911 703 1369 748">Acceptable Number</th> </tr> <tr> <th data-bbox="608 748 759 792">X(mm)</th> <th data-bbox="759 748 911 792">Y(mm)</th> <th data-bbox="911 748 1062 792">A</th> <th data-bbox="1062 748 1214 792">B</th> <th data-bbox="1214 748 1369 792">C</th> </tr> </thead> <tbody> <tr> <td data-bbox="608 792 759 837">—</td> <td data-bbox="759 792 911 837">$0.02 \geq W$</td> <td data-bbox="911 792 1062 837">*</td> <td data-bbox="1062 792 1214 837">*</td> <td data-bbox="1214 792 1369 837">*</td> </tr> <tr> <td data-bbox="608 837 759 882">$2.0 \geq L$</td> <td data-bbox="759 837 911 882">$0.03 \geq W$</td> <td data-bbox="911 837 1062 882">3</td> <td data-bbox="1062 837 1214 882">3</td> <td data-bbox="1214 837 1369 882">*</td> </tr> <tr> <td data-bbox="608 882 759 927">$1.0 \geq L$</td> <td data-bbox="759 882 911 927">$0.04 \geq W$</td> <td data-bbox="911 882 1062 927">1</td> <td data-bbox="1062 882 1214 927">2</td> <td data-bbox="1214 882 1369 927">*</td> </tr> <tr> <td data-bbox="608 927 759 972">$1.0 \geq L$</td> <td data-bbox="759 927 911 972">$0.05 \geq W$</td> <td data-bbox="911 927 1062 972">0</td> <td data-bbox="1062 927 1214 972">2</td> <td data-bbox="1214 927 1369 972">*</td> </tr> <tr> <td data-bbox="608 972 759 1039">—</td> <td data-bbox="759 972 911 1039">$0.05 < W$</td> <td colspan="3" data-bbox="911 972 1369 1039">In the same way (1)</td> </tr> </tbody> </table> <p data-bbox="624 1055 1075 1084">X : Length Y : Width * : Disregard</p> <p data-bbox="587 1099 932 1128">Total defects shall not exceed 5.</p>	Zone	Acceptable Number			Dimension (mm)	A	B	C	$D \leq 0.1$	*	*	*	$0.1 < D \leq 0.2$	5	5	*	$0.2 < D \leq 0.3$	0	1	*	$0.3 < D$	0	0	*	Zone		Acceptable Number			X(mm)	Y(mm)	A	B	C	—	$0.02 \geq W$	*	*	*	$2.0 \geq L$	$0.03 \geq W$	3	3	*	$1.0 \geq L$	$0.04 \geq W$	1	2	*	$1.0 \geq L$	$0.05 \geq W$	0	2	*	—	$0.05 < W$	In the same way (1)		
Zone	Acceptable Number																																																												
Dimension (mm)	A	B	C																																																										
$D \leq 0.1$	*	*	*																																																										
$0.1 < D \leq 0.2$	5	5	*																																																										
$0.2 < D \leq 0.3$	0	1	*																																																										
$0.3 < D$	0	0	*																																																										
Zone		Acceptable Number																																																											
X(mm)	Y(mm)	A	B	C																																																									
—	$0.02 \geq W$	*	*	*																																																									
$2.0 \geq L$	$0.03 \geq W$	3	3	*																																																									
$1.0 \geq L$	$0.04 \geq W$	1	2	*																																																									
$1.0 \geq L$	$0.05 \geq W$	0	2	*																																																									
—	$0.05 < W$	In the same way (1)																																																											
2	Air Bubbles (between glass & polarizer)	<table border="1" data-bbox="608 1184 1369 1469"> <thead> <tr> <th data-bbox="608 1184 911 1229">Zone</th> <th colspan="3" data-bbox="911 1184 1369 1229">Acceptable Number</th> </tr> <tr> <th data-bbox="608 1229 911 1274">Dimension (mm)</th> <th data-bbox="911 1229 1062 1274">A</th> <th data-bbox="1062 1229 1214 1274">B</th> <th data-bbox="1214 1229 1369 1274">C</th> </tr> </thead> <tbody> <tr> <td data-bbox="608 1274 911 1319">$D \leq 0.15$</td> <td data-bbox="911 1274 1062 1319">*</td> <td data-bbox="1062 1274 1214 1319">*</td> <td data-bbox="1214 1274 1369 1319">*</td> </tr> <tr> <td data-bbox="608 1319 911 1364">$0.15 < D \leq 0.3$</td> <td data-bbox="911 1319 1062 1364">2</td> <td data-bbox="1062 1319 1214 1364">3</td> <td data-bbox="1214 1319 1369 1364">*</td> </tr> <tr> <td data-bbox="608 1364 911 1408">$0.3 < D \leq 0.5$</td> <td data-bbox="911 1364 1062 1408">1</td> <td data-bbox="1062 1364 1214 1408">2</td> <td data-bbox="1214 1364 1369 1408">*</td> </tr> <tr> <td data-bbox="608 1408 911 1469">$0.5 < D \leq 1.0$</td> <td data-bbox="911 1408 1062 1469">0</td> <td data-bbox="1062 1408 1214 1469">1</td> <td data-bbox="1214 1408 1369 1469">*</td> </tr> </tbody> </table> <p data-bbox="624 1485 772 1514">* : Disregard</p> <p data-bbox="587 1529 932 1559">Total defects shall not exceed 3.</p>	Zone	Acceptable Number			Dimension (mm)	A	B	C	$D \leq 0.15$	*	*	*	$0.15 < D \leq 0.3$	2	3	*	$0.3 < D \leq 0.5$	1	2	*	$0.5 < D \leq 1.0$	0	1	*																																			
Zone	Acceptable Number																																																												
Dimension (mm)	A	B	C																																																										
$D \leq 0.15$	*	*	*																																																										
$0.15 < D \leq 0.3$	2	3	*																																																										
$0.3 < D \leq 0.5$	1	2	*																																																										
$0.5 < D \leq 1.0$	0	1	*																																																										

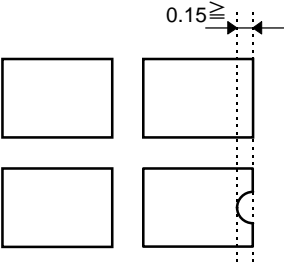
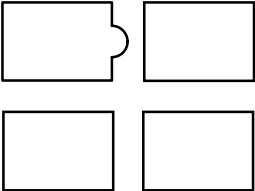
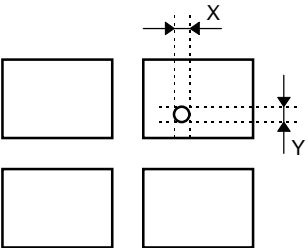

No.	Parameter	Criteria
3	The Shape of Dot	<p>(1) Dot Shape (with Dent)</p>  <p>As per the sketch of left hand.</p> <p>(2) Dot Shape (with Projection)</p>  <p>Should not be connected to next dot.</p> <p>(3) Pin Hole</p>  <p>$(X+Y) / 2 \leq 0.2\text{mm}$ (Less than 0.1mm is no counted.)</p> <p>Total defects shall not exceed 5.</p>
4	Polarizer Scratches	Not to be conspicuous defects.
5	Polarizer Dirts	If the stains are removed easily from LCDP surface, the module is not defective.
6	Color Variation	Not to be conspicuous defects.

7. Code System of Production Lot

The production lot of module is specified as follows.



8. Type Number

The type number of module is specified on the back of module as follows.

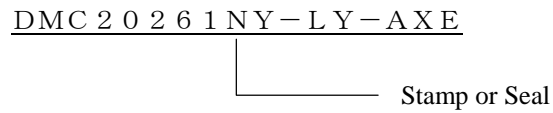

9. Applying Precautions

Please contact us when questions and/or new problems not specified in this specifications arise.

10. Precautions Relating Product Handling

The Following precautions will guide you in handling our product correctly.

1) Liquid crystal display devices

- ① The liquid crystal display device panel used in the liquid crystal display module is made of plate glass. Avoid any strong mechanical shock. Should the glass break handle it with care.
- ② The polarizer adhering to the surface of the LCD is made of a soft material. Guard against scratching it.

2) Care of the liquid crystal display module against static electricity discharge.

- ① When working with the module, be sure to ground your body and any electrical equipment you may be using. We strongly recommend the use of anti static mats (made of rubber), to protect work tables against the hazards of electrical shock.
- ② Avoid the use of work clothing made of synthetic fibers. We recommend cotton clothing or other conductivity-treated fibers.
- ③ Slowly and carefully remove the protective film from the LCD module, since this operation can generate static electricity.

3) When the LCD module alone must be stored for long periods of time:

- ① Protect the modules from high temperature and humidity.
- ② Keep the modules out of direct sunlight or direct exposure to ultraviolet rays.
- ③ Protect the modules from excessive external forces.

4) Use the module with a power supply that is equipped with an overcurrent protector circuit, since the module is not provided with this protective feature.

5) Do not ingest the LCD fluid itself should it leak out of a damaged LCD module. Should hands or clothing come in contact with LCD fluid, wash immediately with soap.

6) Conductivity is not guaranteed for models that use metal holders where solder connections between the metal holder and the PCB are not used. Please contact us to discuss appropriate ways to assure conductivity.

7) For models which use CFL:

- ① High voltage of 1000V or greater is applied to the CFL cable connector area. Care should be taken not to touch connection areas to avoid burns.
- ② Protect CFL cables from rubbing against the unit and thus causing the wire jacket to become worn.
- ③ The use of CFLs for extended periods of time at low temperatures will significantly shorten their service life.

8) For models which use touch panels:

- ① Do not stack up modules since they can be damaged by components on neighboring modules.
- ② Do not place heavy objects on top of the product. This could cause glass breakage.

9) For models which use COG, TAB, or COF:

- ① The mechanical strength of the product is low since the IC chip faces out unprotected from the rear. Be sure to protect the rear of the IC chip from external forces.
- ② Given the fact that the rear of the IC chip is left exposed, in order to protect the unit from electrical damage, avoid installation configurations in which the rear of the IC chip runs the risk of making any electrical contact.

10) Models which use flexible cable, heat seal, or TAB:

- ① In order to maintain reliability, do not touch or hold by the connector area.
- ② Avoid any bending, pulling, or other excessive force, which can result in broken connections.

11. Warranty

This product has been manufactured to your company's specifications as a part for use in your company's general electronic products. It is guaranteed to perform according to delivery specifications. For any other use apart from general electronic equipment, we cannot take responsibility if the product is used in medical devices, nuclear power control equipment, aerospace equipment, fire and security systems, or any other applications in which there is a direct risk to human life and where extremely high levels of reliability are required. If the product is to be used in any of the above applications, we will need to enter into a separate product liability agreement.

- ① We cannot accept responsibility for any defect, which may arise from additional manufacturing of the product (including disassembly and reassembly), after product delivery.
- ② We cannot accept responsibility for any defect, which may arise after the application of strong external force to the product.
- ③ We cannot accept responsibility for any defect, which may arise due to the application of static electricity after the product has passed your company's acceptance inspection procedures.
- ④ When the product is in CFL models, CFL service life and brightness will vary according to the performance of the inverter used, leaks, etc. We cannot accept responsibility for product performance, reliability, or defect, which may arise.
- ⑤ We cannot accept responsibility for industrial property, which may arise through the use of your product, with exception to those issues relating directly to the structure or method of manufacturing of our product.
- ⑥ Optrex will not be held responsible for any quality guarantee issue for defect products judged as Optrex-origin longer than 2 (two) years from Optrex production or 1(one) year from Optrex, Optrex America, Optrex Europe, Display LC delivery which ever comes later.