

Silicon Beam-Lead and Chip Schottky Barrier Mixer Diodes

ALPHA IND/ SEMICONDUCTOR

Features

- Ideal for MIC
- Low 1/f Noise
- Low Intermodulation Distortion
- Low Turn On
- Hermetically Sealed Packages

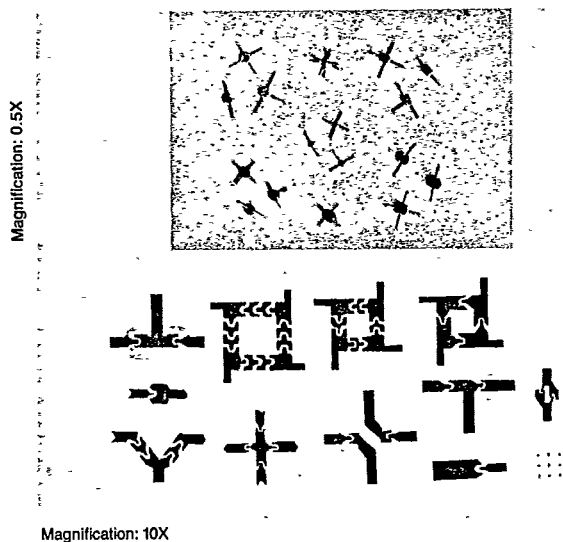

Description

Alpha beam-lead and chip Schottky barrier mixer diodes are designed for applications through 40 GHz in Ka-band. The beam-lead design eliminates the problem of bonding to the very small junction area that is characteristic of the low capacitance involved in microwave devices.

Beam-lead Schottky barrier mixer diodes are made by deposition of a suitable barrier metal on an epitaxial silicon substrate to form the junction. The process and choice of materials result in low series resistance along with a narrow spread of capacitance values for close impedance control.

A variety of forward knees is available, ranging from a low value for low, or starved, local oscillator drive levels to a higher value for high drive, low intermod mixer applications.

The beam-lead diodes are available in a wide range of packages as shown. They may also be mounted on the customer's circuit or on other substrate configurations. For those customers who prefer chip and wire for their MIC work, Alpha can supply a complete line of bondable chips. Capacitance ranges and series resistances are comparable with the packaged devices that are available through Ka-band. The unmounted diodes are especially well suited for use in microwave integrated circuits. The mounted devices can be easily inserted as hybrid elements in stripline, microstrip and other such circuitry.

Applications

Beam-lead and chip Schottky barrier diodes are categorized by noise figure for mixer applications in four frequency ranges: S, X, Ku and Ka-bands. However, they can also be used as modulators, high speed switches and low power limiters.

RF parameters, capacitance and breakdown voltage on chips and beam-lead diodes are tested on a sample basis, while production testing consists of series resis-

tance and forward voltage measurements. A separate data sheet in this section describes beam-lead and chip diodes that are optimized for detector applications.

Several types of semiconductor-barrier metal systems are available, thus allowing proper selection for optimum mixer design. For most applications the N-type silicon, low drive types are preferable, especially for starved L.O. mixers. For doppler mixers, motion detectors or applications requiring low audio (1/f) noise, the P-type silicon, low drive types are preferred. For high level mixer applications requiring low intermodulation products, the N-type silicon, high drive types are most desirable.

Beam-lead diodes are ideally suited for balanced mixers, since they exhibit low parasitics and are extremely uniform. A typical V_f vs I_f curve is shown in Figure 1.

Typical noise figure vs L.O. drive is shown in Figure 2 for single N-type, low drive diode types.

Typical mixer circuits are shown in Figure 3 in order of complexity. The circuits shown in Figures 3a and 3b are recommended for narrower band applications.

The matching network can be an "L" network using discrete components at lower frequencies or a section of transmission line. The double balanced mixer in Figure 3c is recommended for broadband operation where noise figure is less important. The use of high drive diodes in this circuit allows the use of increased L.O. drive with a resultant decrease in intermodulation distortion.

See Sections 2 and 7 for Application Notes:

- | | |
|-------|---|
| 80800 | Mixer and Detector Diodes |
| 80850 | Handling Precautions for Schottky Barrier and Point Contact Mixer and Detector Diodes |
| 80000 | Bonding Methods: Diode Chips, Beam-Lead Diodes and Capacitors |

Silicon Beam-Lead and Chip Schottky Barrier Mixer Diodes

ALPHA IND/ SEMICONDUCTOR

FREQUENCY TABLE

Band	Frequencies (GHz)
S	2 to 4
C	4 to 8
X	8.2 to 12.4
Ku	12.4 to 18.0
K	18.0 to 26.5
Ka	26.5 to 40.0

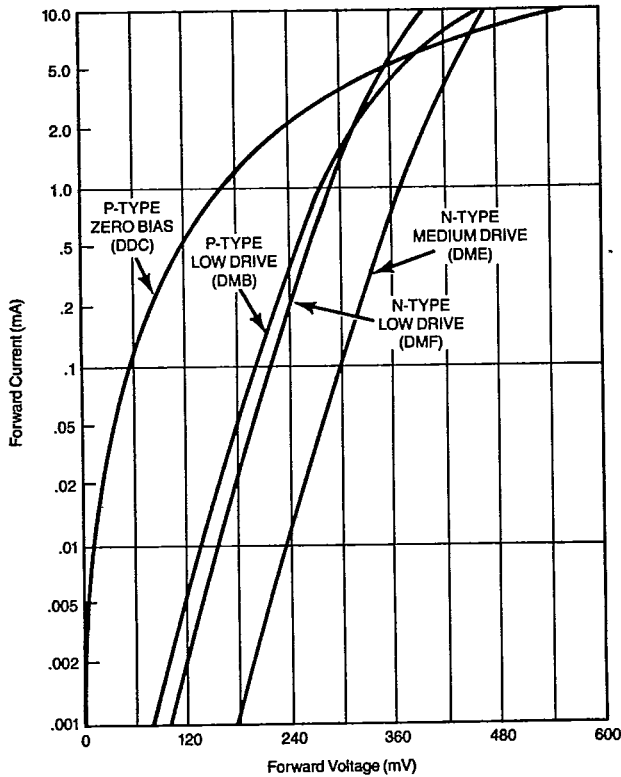

Figure 1a. Typical Forward DC Characteristic Curves — Voltage vs Current

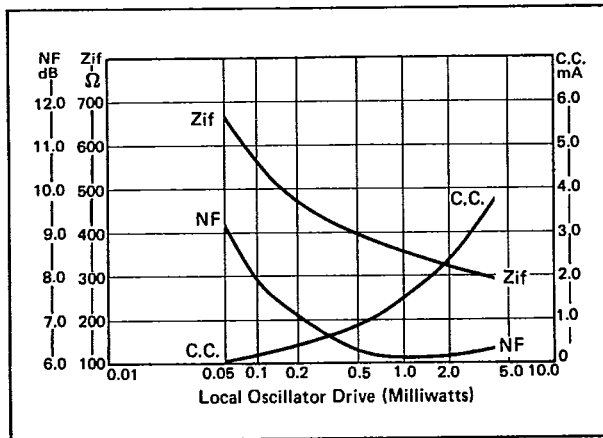

Figure 2. Typical X-Band Low Drive Mixer Diode — RF Parameters vs Local Oscillator Drive

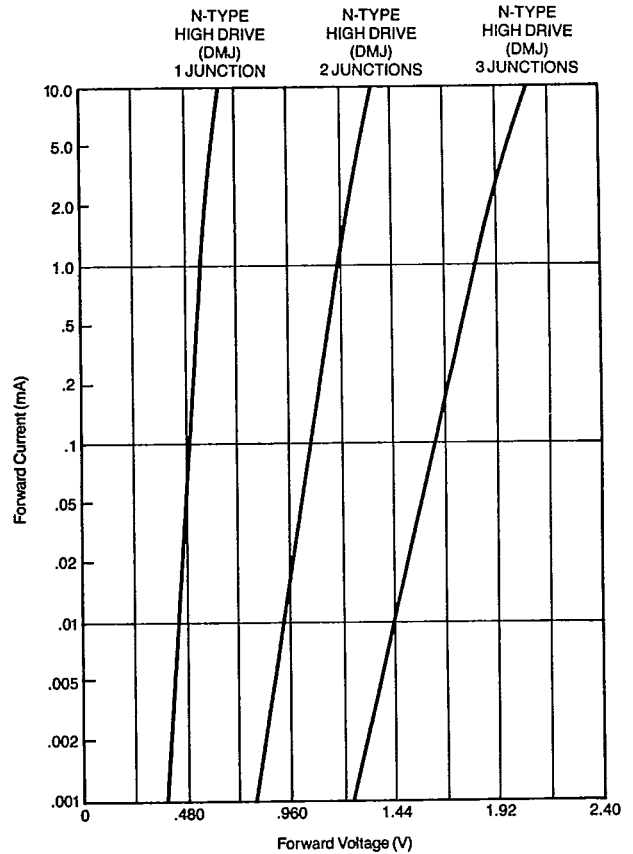

Figure 1b. Typical Forward DC Characteristic Curves — Voltage vs Current

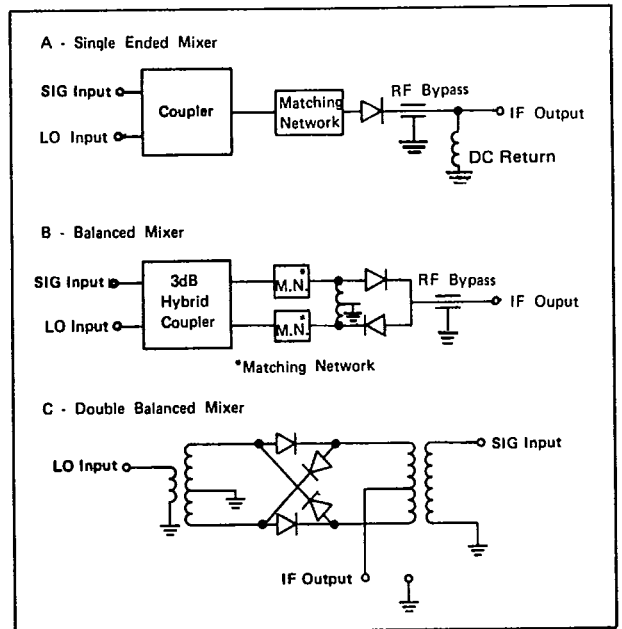
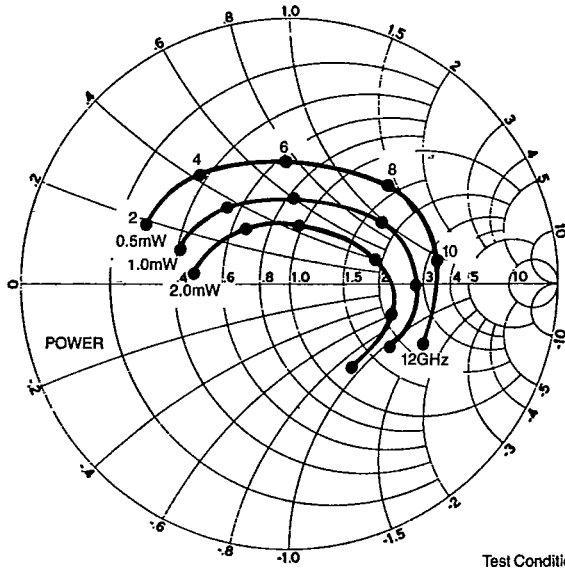

Figure 3. Typical Mixer Circuits

Silicon Beam-Lead and Chip Schottky Barrier Mixer Diodes

ALPHA IND/ SEMICONDUCTOR



Test Conditions
 $R_L = 10 \text{ ohms}$

Typical DMB6780
Low Drive X-Band Mixer Diode
Admittance Characteristics

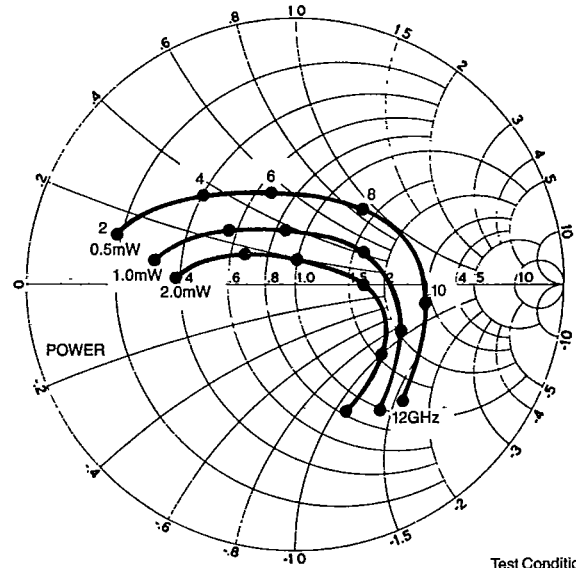

Test Conditions
 $R_L = 10 \text{ ohms}$

Typical DMB3000
Low Drive X-Band Mixer Diode
Admittance Characteristics

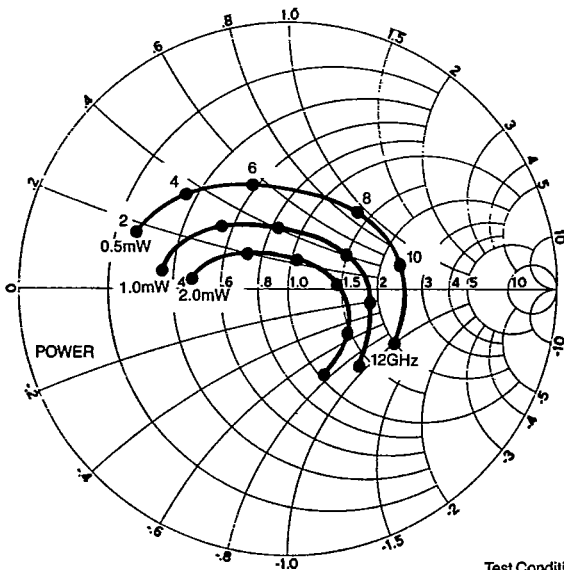

Test Conditions
 $R_L = 10 \text{ ohms}$

Typical DMB3003
Low Drive X-Band Mixer Diode
Admittance Characteristics

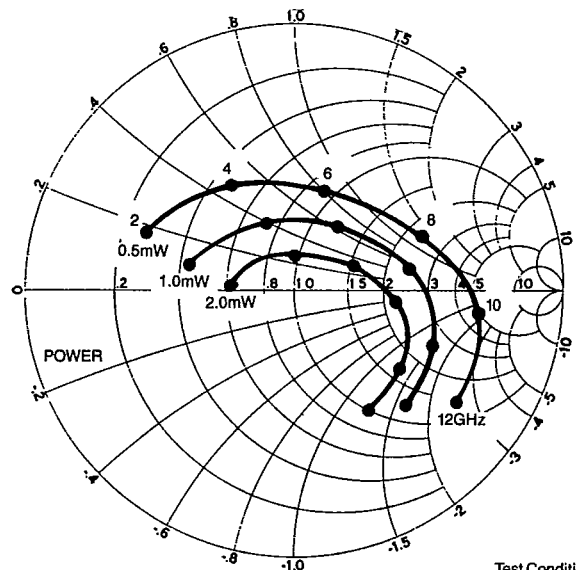

Test Conditions
 $R_L = 10 \text{ ohms}$

Typical DMF5827
Low Drive X-Band Mixer Diode
Admittance Characteristics

Silicon Beam-Lead and Chip Schottky Barrier Mixer Diodes

ALPHA IND/ SEMICONDUCTOR

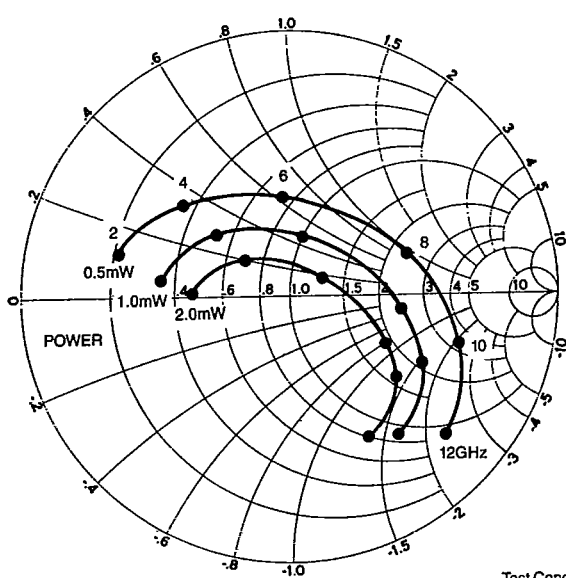

Test Conditions
 $R_L = 10$ ohms

Typical DMF3068
Low Drive X-Band Mixer Diode
Admittance Characteristics

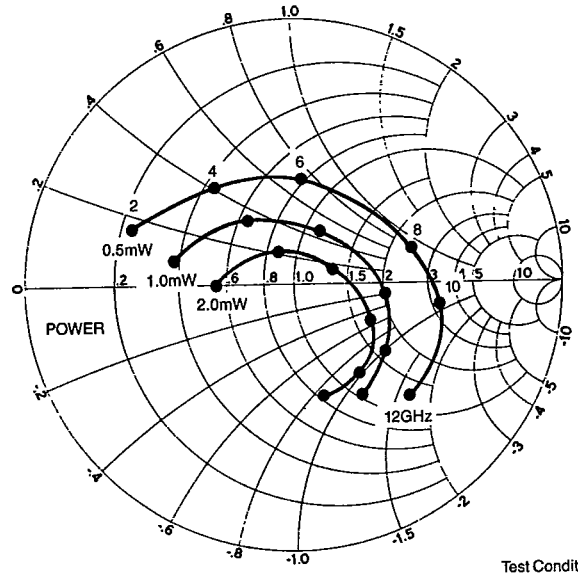

Test Conditions
 $R_L = 10$ ohms

Typical DMF3064
Low Drive X-Band Mixer Diode
Admittance Characteristics

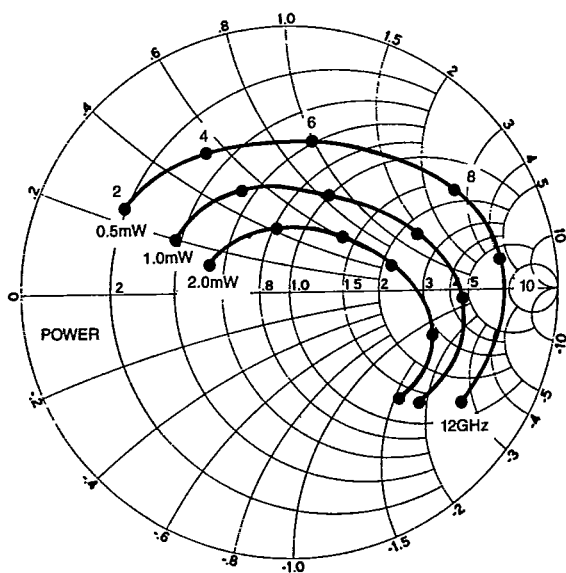

Test Conditions
 $R_L = 10$ ohms

Typical DME3055
Medium Drive X-Band Mixer Diode
Admittance Characteristics

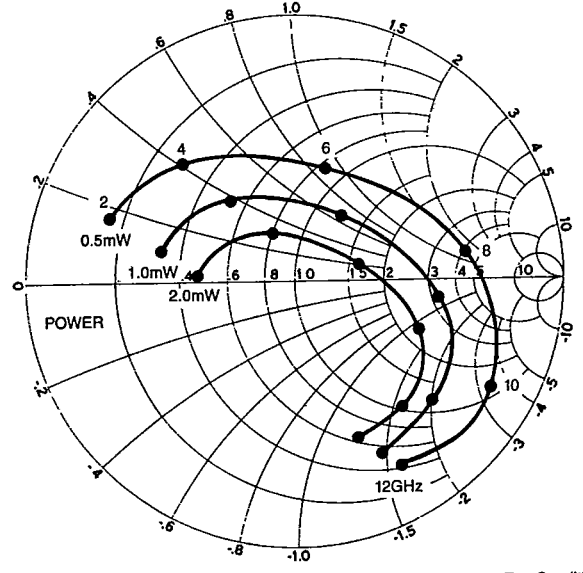

Test Conditions
 $R_L = 10$ ohms

Typical DME3057
Medium Drive X-Band Mixer Diode
Admittance Characteristics

Silicon Beam-Lead and Chip Schottky Barrier Mixer Diodes

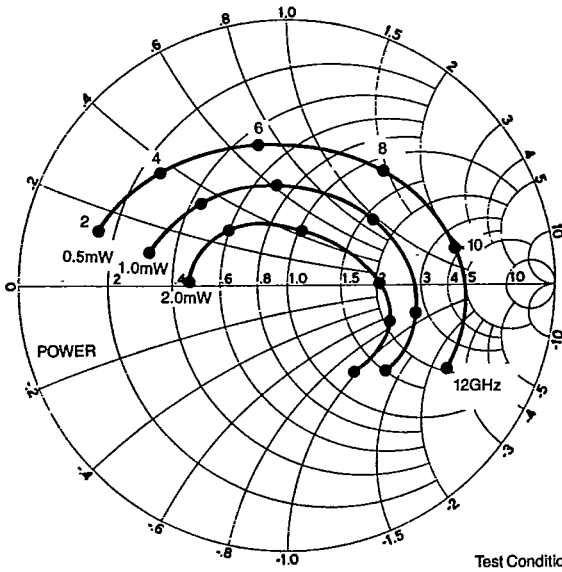

Typical DME3125
 Medium Drive X-Band Mixer Diode
 Admittance Characteristics

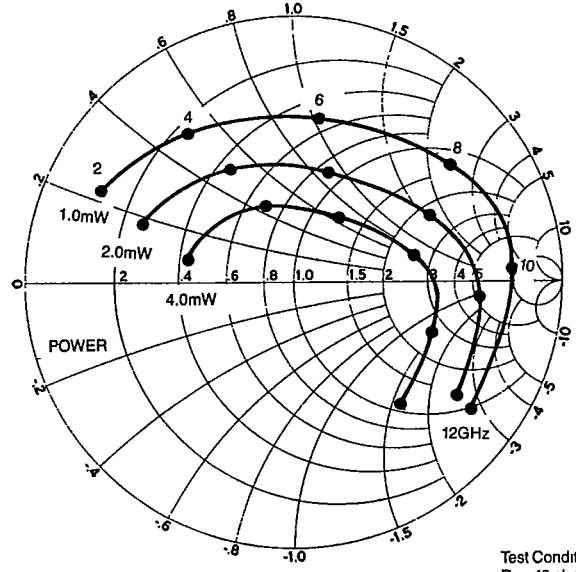

Typical DMJ6786
 High Drive X-Band Mixer Diode
 Admittance Characteristics

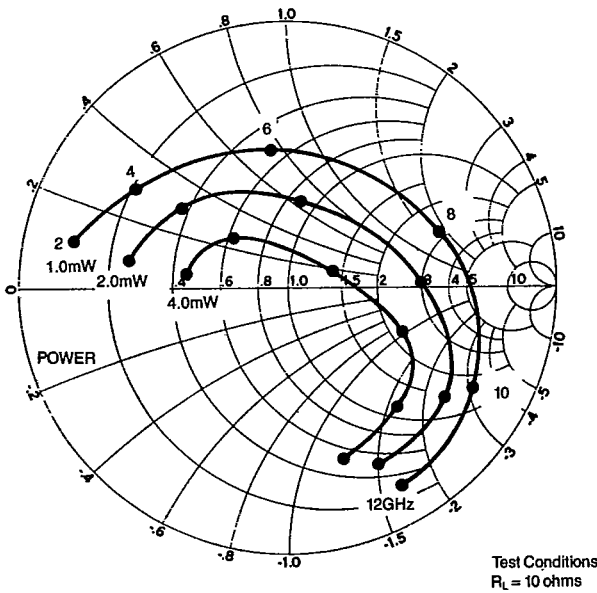

Typical DMJ3151
 High Drive X-Band Mixer Diode
 Admittance Characteristics

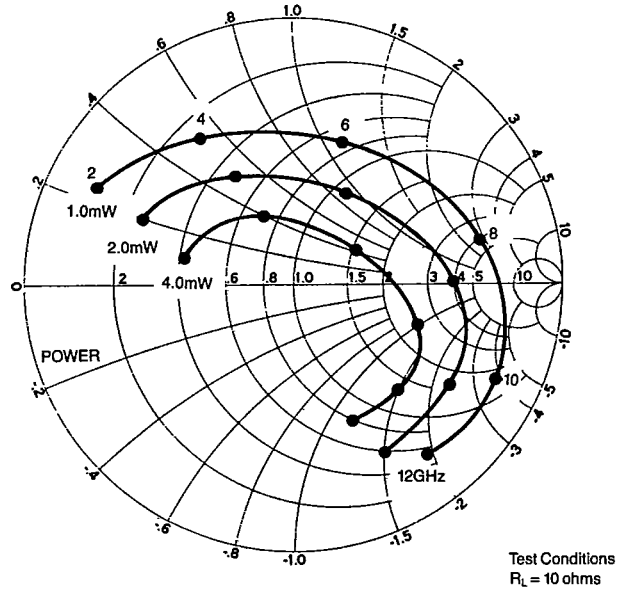

Typical DMJ3154
 High Drive X-Band Mixer Diode
 Admittance Characteristics

Silicon Beam-Lead and Chip Schottky Barrier Mixer Diodes

ALPHA IND/ SEMICONDUCTOR

Beam-Lead Singles, P-Type, Low Drive, Low 1/f Noise (6.0 dB Max.)

Frequency Band	Type Number	Outline	NF ⁽¹⁾ dB Max.	C _j 0V pF		Rs ⁽²⁾ — Ω Max.	V _F 1mA mV		V _B 10μA V Min.
				Min.	Max.		Min.	Max.	
X	DMB6780A	130-011	6.5	0.15	0.30	12	200	300	2.0
X	DMB6780	130-011	7.0	0.15	0.30	18	200	300	2.0
X	DMB4500A	174-002	6.5	0.15	0.30	12	200	300	2.0
X	DMB4500	174-002	7.0	0.15	0.30	18	200	300	2.0
X	DMB3000A	295-011	6.5	0.15	0.30	12	200	300	2.0
X	DMB3000	295-011	7.0	0.15	0.30	18	200	300	2.0
X	DMB6781A	325-011	6.5	0.15	0.30	12	200	300	2.0
X	DMB6781	325-011	7.0	0.15	0.30	18	200	300	2.0
X	DMB3003A	364-011	6.5	0.15	0.30	12	200	300	2.0
X	DMB3003	364-011	7.0	0.15	0.30	18	200	300	2.0
Ku	DMB6782A	130-011	7.5	0.05	0.15	16	200	350	2.0
Ku	DMB6782	130-011	8.0	0.05	0.15	25	200	350	2.0
Ku	DMB4501A	174-002	7.5	0.05	0.15	16	200	350	2.0
Ku	DMB4501	174-002	8.0	0.05	0.15	25	200	350	2.0
Ku	DMB3001A	295-011	7.5	0.05	0.15	16	200	350	2.0
Ku	DMB3001	295-011	8.0	0.05	0.15	25	200	350	2.0
Ku	DMB3004A	364-011	7.5	0.05	0.15	16	200	350	2.0
Ku	DMB3004	364-011	8.0	0.05	0.15	25	200	350	2.0

Beam-Lead Singles, N-Type, Low Drive

Frequency Band	Type Number	Outline	NF ⁽¹⁾ dB Max.	C _j 0V pF		Rs ⁽²⁾ — Ω Max.	V _F 1mA mV		V _B 10μA V Min.
				Min.	Max.		Min.	Max.	
S	DMF5845A	130-011	6.0	0.30	0.50	3	225	300	2.0
S	DMF5845	130-011	6.5	0.30	0.50	7	225	300	2.0
S	DMF5817A	174-001	6.0	0.30	0.50	3	225	300	2.0
S	DMF5817	174-001	6.5	0.30	0.50	7	225	300	2.0
S	DMF5079A	325-011	6.0	0.30	0.50	3	225	300	2.0
S	DMF5079	325-011	6.5	0.30	0.50	7	225	300	2.0
S	DMF4365A	364-011	6.0	0.30	0.50	3	225	300	2.0
S	DMF4365	364-011	6.5	0.30	0.50	7	225	300	2.0
X	DMF5827A	130-011	6.5	0.15	0.30	7	250	325	2.0
X	DMF5827	130-011	7.0	0.15	0.30	12	250	325	2.0
X	DMF5818A	174-001	6.5	0.15	0.30	7	250	325	2.0
X	DMF5818	174-001	7.0	0.15	0.30	12	250	325	2.0
X	DMF3068A	295-011	6.5	0.15	0.30	7	250	325	2.0
X	DMF3068	295-011	7.0	0.15	0.30	12	250	325	2.0
X	DMF4035A	325-011	6.5	0.15	0.30	7	250	325	2.0
X	DMF4035	325-011	7.0	0.15	0.30	12	250	325	2.0
X	DMF3064A	364-011	6.5	0.15	0.30	7	250	325	2.0
X	DMF3064	364-011	7.0	0.15	0.30	12	250	325	2.0

Notes:

1 N_f = 1.5 dB, L.O. = 1.0 mW, R_L = 100Ω

Band	Test Frequency (GHz)
S	3.1
X	9.4
Ku	16.0
Ka	34.9

2 R_s = R_i - R_B where R_i is the total resistance measured across the diode terminals and R_B is the barrier resistance (2.8Ω for a Schottky barrier diode measured at 10mA. For multiple junction devices, the R_B would be 2.8Ω times the number of junctions between the diode terminals).

3 Electrical characteristics are specified for each junction except for those devices containing two or more junctions in series per arm. For these cases, the specification is for the arm.

Silicon Beam-Lead and Chip Schottky Barrier Mixer Diodes

ALPHA IND/ SEMICONDUCTOR

Beam-Lead Singles, N-Type, Low Drive (cont.)

Frequency Band	Type Number	Outline	NF ⁽¹⁾ dB Max.	C _J 0V pF		R _s ⁽²⁾ — Ω Max.	V _F 1mA mV		V _B 10μA V Min.
				Min.	Max.		Min.	Max.	
Ku	DMF6022A	130-011	7.5	0.05	0.15	16	275	350	2.0
Ku	DMF6022	130-011	8.0	0.05	0.15	25	275	350	2.0
Ku	DMF5600A	174-001	7.5	0.05	0.15	16	275	350	2.0
Ku	DMF5600	174-001	8.0	0.05	0.15	25	275	350	2.0
Ku	DMF3069A	295-011	7.5	0.05	0.15	16	275	350	2.0
Ku	DMF3069	295-011	8.0	0.05	0.15	25	275	350	2.0
Ku	DMF3065A	364-011	7.5	0.05	0.15	16	275	350	2.0
Ku	DMF3065	364-011	8.0	0.05	0.15	25	275	350	2.0

Beam-Lead Singles, N-Type, Medium Drive

Frequency Band	Type Number	Outline	NF ⁽¹⁾ dB Max.	C _J 0V pF		R _s ⁽²⁾ — Ω Max.	V _F 1mA mV		V _B 10μA V Min.
				Min.	Max.		Min.	Max.	
S	DME3128	130-011	6.0	0.30	0.50	4	300	400	3.0
S	DME3127	174-001	6.0	0.30	0.50	4	300	400	3.0
S	DME3006	325-011	6.0	0.30	0.50	4	300	400	3.0
S	DME3124	364-011	6.0	0.30	0.50	4	300	400	3.0
X	DME3055	130-011	6.5	0.15	0.30	9	325	425	3.0
X	DME6957	174-001	6.5	0.15	0.30	9	325	425	3.0
X	DME3057	295-011	6.5	0.15	0.30	9	325	425	3.0
X	DME3005	325-011	6.5	0.15	0.30	9	325	425	3.0
X	DME3125	364-011	6.5	0.15	0.30	9	325	425	3.0
Ku	DME3056	130-011	7.5	0.05	0.15	16	350	450	3.0
Ku	DME6507	174-001	7.5	0.05	0.15	16	350	450	3.0
Ku	DME3058	295-011	7.5	0.05	0.15	16	350	450	3.0
Ku	DME3126	364-011	7.5	0.05	0.15	16	350	450	3.0

Beam-Lead Singles, N-Type, High Drive

Frequency Band	Type Number	Outline	NF ⁽¹⁾ dB Max.	C _J 0V pF		R _s ⁽²⁾ — Ω Max.	V _F 1mA mV		V _B 10μA V Min.
				Min.	Max.		Min.	Max.	
S	DMJ6784	130-011	6.0	0.30	0.50	4	550	625	4.0
S	DMJ5034	174-001	6.0	0.30	0.50	4	550	625	4.0
S	DMJ6785	325-011	6.0	0.30	0.50	4	550	625	4.0
S	DMJ3153	364-011	6.0	0.30	0.50	4	550	625	4.0
X	DMJ6786	130-011	6.5	0.15	0.30	9	550	650	5.0
X	DMJ6777	174-001	6.5	0.15	0.30	9	550	650	5.0
X	DMJ3151	295-011	6.5	0.15	0.30	9	550	650	5.0
X	DMJ6789	325-011	6.5	0.15	0.30	9	550	650	5.0
X	DMJ3154	364-011	6.5	0.15	0.30	9	550	650	5.0
Ku	DMJ6670	130-011	7.5	0.05	0.15	13	600	750	5.0
Ku	DMJ6778	174-001	7.5	0.05	0.15	13	600	750	5.0
Ku	DMJ3152	295-011	7.5	0.05	0.15	13	600	750	5.0
Ku	DMJ3155	364-011	7.5	0.05	0.15	13	600	750	5.0

Notes:

1 N_r = 1.5 dB, L.O. = 1.0 mW, R_L = 100Ω

Band	Test Frequency (GHz)
S	3.1
X	9.4
Ku	16.0
Ka	34.9

2 R_s = R_L - R_B where R_L is the total resistance measured across the diode terminals and R_B is the barrier resistance (2.8Ω for a Schottky barrier diode measured at 10mA. For multiple junction devices, the R_B would be 2.8Ω times the number of junctions between the diode terminals).

3 Electrical characteristics are specified for each junction except for those devices containing two or more junctions in series per arm. For these cases, the specification is for the arm.

Silicon Beam-Lead and Chip Schottky Barrier Mixer Diodes

ALPHA IND/ SEMICONDUCTOR

Beam-Lead Pairs, N-Type, Low Drive

Frequency Band	Type Number	Outline	NF ⁽¹⁾ dB Max.	C _i 0V pF		R _s ⁽²⁾ Ω Max.	V _F 1mA mV		ΔV _F ⁽⁴⁾ 1mA mV Max.	V _B 10μA V Min.
				Min.	Max.		Min.	Max.		
S	DMF3226A	130-025	6.0	0.30	0.50	3	225	300	10	2.0
S	DMF3226	130-025	6.5	0.30	0.50	7	225	300	10	2.0
S	DMF5846A	131-012	6.0	0.30	0.50	3	225	300	10	2.0
S	DMF5846	131-012	6.5	0.30	0.50	7	225	300	10	2.0
S	DMF4040A	132-008	6.0	0.30	0.50	3	225	300	10	2.0
S	DMF4040	132-008	6.5	0.30	0.50	7	225	300	10	2.0
S	DMF3230A	295-025	6.0	0.30	0.50	3	225	300	10	2.0
S	DMF3230	295-025	6.5	0.30	0.50	7	225	300	10	2.0
S	DMF3070A	325-008	6.0	0.30	0.50	3	225	300	10	2.0
S	DMF3070	325-008	6.5	0.30	0.50	7	225	300	10	2.0
S	DMF6576A	325-012	6.0	0.30	0.50	3	225	300	10	2.0
S	DMF6576	325-012	6.5	0.30	0.50	7	225	300	10	2.0
S	DMF3291A	325-025	6.0	0.30	0.50	3	225	300	10	2.0
S	DMF3291	325-025	6.5	0.30	0.50	7	225	300	10	2.0
S	DMF5835A	378-012	6.0	0.30	0.50	3	225	300	10	2.0
S	DMF5835	378-012	6.5	0.30	0.50	7	225	300	10	2.0
S	DMF3182A	378-013	6.0	0.30	0.50	3	225	300	10	2.0
S	DMF3182	378-013	6.5	0.30	0.50	7	225	300	10	2.0
S	DMF3185A	396-025	6.0	0.30	0.50	3	225	300	10	2.0
S	DMF3185	396-025	6.5	0.30	0.50	7	225	300	10	2.0
S	DMF3196A	408-009	6.0	0.30	0.50	3	225	300	10	2.0
S	DMF3196	408-009	6.5	0.30	0.50	7	225	300	10	2.0
X	DMF3245A	130-025	6.5	0.15	0.30	7	250	325	10	2.0
X	DMF3245	130-025	7.0	0.15	0.30	12	250	325	10	2.0
X	DMF6460A	131-012	6.5	0.15	0.30	7	250	325	10	2.0
X	DMF6460	131-012	7.0	0.15	0.30	12	250	325	10	2.0
X	DMF5828A	132-008	6.5	0.15	0.30	7	250	325	10	2.0
X	DMF5828	132-008	7.0	0.15	0.30	12	250	325	10	2.0
X	DMF3072A	295-008	6.5	0.15	0.30	7	250	325	10	2.0
X	DMF3072	295-008	7.0	0.15	0.30	12	250	325	10	2.0
X	DMF3066A	295-012	6.5	0.15	0.30	7	250	325	10	2.0
X	DMF3066	295-012	7.0	0.15	0.30	12	250	325	10	2.0
X	DMF3289A	295-025	6.5	0.15	0.30	7	250	325	10	2.0
X	DMF3289	295-025	7.0	0.15	0.30	12	250	325	10	2.0
X	DMF3071A	325-008	6.5	0.15	0.30	7	250	325	10	2.0
X	DMF3071	325-008	7.0	0.15	0.30	12	250	325	10	2.0
X	DMF6704A	325-012	6.5	0.15	0.30	7	250	325	10	2.0
X	DMF6704	325-012	7.0	0.15	0.30	12	250	325	10	2.0
X	DMF3292A	325-025	6.5	0.15	0.30	7	250	325	10	2.0

Notes:

1 N_r = 1.5 dB, L.O. = 1.0 mW, R_i = 100Ω

Band	Test Frequency (GHz)
S	3.1
X	9.4
Ku	16.0
Ka	34.9

- R_s = R_t - R_b where R_t is the total resistance measured across the diode terminals and R_b is the barrier resistance (2.8Ω for a Schottky barrier diode measured at 10 mA. For multiple junction devices, the R_b would be 2.8Ω times the number of junctions between the diode terminals).
- Electrical characteristics are specified for each junction except for those devices containing two or more junctions in series per arm. For these cases, the specification is for the arm.
- Difference in forward voltage between leads within a pair or quad.

Silicon Beam-Lead and Chip Schottky Barrier Mixer Diodes

ALPHA IND/ SEMICONDUCTOR

Beam-Lead Pairs, N-Type, Low Drive (cont.)

Frequency Band	Type Number	Outline	NF ⁽¹⁾ dB Max.	C _J pF		R _s ⁽²⁾ Ω Max.	V _F 1mA mV		ΔV _F ⁽⁴⁾ 1mA mV Max.	V _B 10μA V Min.
				Min.	Max.		Min.	Max.		
X	DMF3292	325-025	7.0	0.15	0.30	12	250	325	10	2.0
X	DMF4713A	364-008	6.5	0.15	0.30	7	250	325	10	2.0
X	DMF4713	364-008	7.0	0.15	0.30	12	250	325	10	2.0
X	DMF4526A	364-012	6.5	0.15	0.30	7	250	325	10	2.0
X	DMF4526	364-012	7.0	0.15	0.30	12	250	325	10	2.0
X	DMF5819A	378-012	6.5	0.15	0.30	7	250	325	10	2.0
X	DMF5819	378-012	7.0	0.15	0.30	12	250	325	10	2.0
X	DMF3183A	378-013	6.5	0.15	0.30	7	250	325	10	2.0
X	DMF3183	378-013	7.0	0.15	0.30	12	250	325	10	2.0
X	DMF3186A	396-025	6.5	0.15	0.30	7	250	325	10	—
X	DMF3186	396-025	7.0	0.15	0.30	12	250	325	10	—
X	DMF3197A	408-009	6.5	0.15	0.30	7	250	325	10	2.0
X	DMF3197	408-009	7.0	0.15	0.30	12	250	325	10	2.0
Ku	DMF3286A	130-025	7.5	0.05	0.15	16	275	350	10	2.0
Ku	DMF3286	130-025	8.0	0.05	0.15	25	275	350	10	2.0
Ku	DMF6459A	131-012	7.5	0.05	0.15	16	275	350	10	2.0
Ku	DMF6459	131-012	8.0	0.05	0.15	25	275	350	10	2.0
Ku	DMF6023A	132-008	7.5	0.05	0.15	16	275	350	10	2.0
Ku	DMF6023	132-008	8.0	0.05	0.15	25	275	350	10	2.0
Ku	DMF3073A	295-008	7.5	0.05	0.15	16	275	350	10	2.0
Ku	DMF3073	295-008	8.0	0.05	0.15	25	275	350	10	2.0
Ku	DMF6554A	295-012	7.5	0.05	0.15	16	275	350	10	2.0
Ku	DMF6554	295-012	8.0	0.05	0.15	25	275	350	10	2.0
Ku	DMF3290A	295-025	7.5	0.05	0.15	16	275	350	10	—
Ku	DMF3290	295-025	8.0	0.05	0.15	25	275	350	10	—
Ku	DMF3293A	325-025	7.5	0.05	0.15	16	275	350	10	—
Ku	DMF3293	325-025	8.0	0.05	0.15	25	275	350	10	—
Ku	DMF3062A	364-008	7.5	0.05	0.15	16	275	350	10	2.0
Ku	DMF3062	364-008	8.0	0.05	0.15	25	275	350	10	2.0
Ku	DMF4734A	364-012	7.5	0.05	0.15	16	275	350	10	2.0
Ku	DMF4734	364-012	8.0	0.05	0.15	25	275	350	10	2.0
Ku	DMF4788A	378-012	7.5	0.05	0.15	16	275	350	10	2.0
Ku	DMF4788	378-012	8.0	0.05	0.15	25	275	350	10	2.0
Ku	DMF3184A	378-013	7.5	0.05	0.15	16	275	350	10	2.0
Ku	DMF3184	378-013	8.0	0.05	0.15	25	275	350	10	2.0
Ku	DMF3187A	396-025	7.5	0.05	0.15	16	275	350	10	—
Ku	DMF3187	396-025	8.0	0.05	0.15	25	275	350	10	—
Ku	DMF3198A	408-009	7.5	0.05	0.15	16	275	350	10	2.0
Ku	DMF3198	408-009	8.0	0.05	0.15	25	275	350	10	2.0

Notes:

1 N_d = 1.5 dB, L.O. = 1.0 mW, R_L = 100Ω

Band	Test Frequency (GHz)
S	3.1
X	9.4
Ku	16.0
Ka	34.9

2 R_s = R_L - R_B where R_L is the total resistance measured across the diode terminals and R_B is the barrier resistance (2.8Ω for a Schottky barrier diode measured at 10 mA. For multiple junction devices, the R_B would be 2.8Ω times the number of junctions between the diode terminals).

3 Electrical characteristics are specified for each junction except for those devices containing two or more junctions in series per arm. For these cases, the specification is for the arm.

4 Difference in forward voltage between leads within a pair or quad.

Silicon Beam-Lead and Chip Schottky Barrier Mixer Diodes

ALPHA IND/ SEMICONDUCTOR

Beam-Lead Pairs, N-Type, Medium Drive

Frequency Band	Type Number	Outline	NF ⁽¹⁾ dB Max.	C _J pF		R _s ⁽²⁾ Ω Max.	V _F 1mA mV		ΔV _F ⁽⁴⁾ 1mA mV Max.	V _B 10μA V Min.
				Min.	Max.		Min.	Max.		
S	DME3270	130-025	6.0	0.30	0.50	4	300	400	10	—
S	DME3012	131-012	6.0	0.30	0.50	4	300	400	10	3.0
S	DME3009	132-008	6.0	0.30	0.50	4	300	400	10	3.0
S	DME3275	295-025	6.0	0.30	0.50	4	300	400	10	—
S	DME3019	325-008	6.0	0.30	0.50	4	300	400	10	3.0
S	DME3021	325-012	6.0	0.30	0.50	4	300	400	10	3.0
S	DME3278	325-025	6.0	0.30	0.50	4	300	400	10	—
S	DME3050	378-012	6.0	0.30	0.50	4	300	400	10	3.0
S	DME3205	378-013	6.0	0.30	0.50	4	300	400	10	3.0
S	DME3282	396-025	6.0	0.30	0.50	4	300	400	10	—
S	DME3199	408-009	6.0	0.30	0.50	4	300	400	10	3.0
X	DME3271	130-025	6.5	0.15	0.30	9	325	425	10	—
X	DME3013	131-012	6.5	0.15	0.30	9	325	425	10	3.0
X	DME3010	132-008	6.5	0.15	0.30	9	325	425	10	3.0
X	DME3015	295-008	6.5	0.15	0.30	9	325	425	10	3.0
X	DME6569	295-012	6.5	0.15	0.30	9	325	425	10	—
X	DME3276	295-025	6.5	0.15	0.30	9	325	425	10	3.0
X	DME3020	325-008	6.5	0.15	0.30	9	325	425	10	3.0
X	DME3022	325-012	6.5	0.15	0.30	9	325	425	10	—
X	DME3279	325-025	6.5	0.15	0.30	9	325	425	10	3.0
X	DME3023	364-008	6.5	0.15	0.30	9	325	425	10	3.0
X	DME3025	364-012	6.5	0.15	0.30	9	325	425	10	3.0
X	DME3051	378-012	6.5	0.15	0.30	9	325	425	10	3.0
X	DME3206	378-013	6.5	0.15	0.30	9	325	425	10	—
X	DME3283	396-025	6.5	0.15	0.30	9	325	425	10	3.0
X	DME3200	408-009	6.5	0.15	0.30	9	325	425	10	3.0
Ku	DME3272	130-025	7.5	0.05	0.15	16	350	450	10	—
Ku	DME3014	131-012	7.5	0.05	0.15	16	350	450	10	3.0
Ku	DME3011	132-008	7.5	0.05	0.15	16	350	450	10	3.0
Ku	DME3016	295-008	7.5	0.05	0.15	16	350	450	10	3.0
Ku	DME3054	295-012	7.5	0.05	0.15	16	350	450	10	—
Ku	DME3277	295-025	7.5	0.05	0.15	16	350	450	10	—
Ku	DME3280	325-025	7.5	0.05	0.15	16	350	450	10	3.0
Ku	DME3024	364-008	7.5	0.05	0.15	16	350	450	10	3.0
Ku	DME3026	364-012	7.5	0.05	0.15	16	350	450	10	3.0
Ku	DME6553	378-012	7.5	0.05	0.15	16	350	450	10	3.0
Ku	DME3207	378-013	7.5	0.05	0.15	16	350	450	10	—
Ku	DME3284	396-025	7.5	0.05	0.15	16	350	450	10	—
Ku	DME3201	408-009	7.5	0.05	0.15	16	350	450	10	3.0

Notes:

1 N_r = 1.5 dB, L.O. = 1.0 mW, R_L = 100Ω

Band	Test Frequency (GHz)
S	3.1
X	9.4
Ku	16.0
Ka	34.9

2 R_s = R_t - R_B where R_t is the total resistance measured across the diode terminals and R_B is the barrier resistance (2.8Ω for a Schottky barrier diode measured at 10mA. For multiple junction devices, the R_B would be 2.8Ω times the number of junctions between the diode terminals).

3 Electrical characteristics are specified for each junction except for those devices containing two or more junctions in series per arm. For these cases, the specification is for the arm.

4 Difference in forward voltage between leads within a pair or quad.

Silicon Beam-Lead and Chip Schottky Barrier Mixer Diodes

ALPHA IND/ SEMICONDUCTOR

Beam-Lead Pairs, N-Type, High Drive

Frequency Band	Type Number	Outline	NF ⁽¹⁾ dB Max.	C _J pF		R _s ⁽²⁾ Ω Max.	V _F 1mA mV		ΔV _F ⁽⁴⁾ 1mA mV Max.	V _B 10μA V Min.
				Min.	Max.		Min.	Max.		
S	DMJ3294	130-025	6.0	0.30	0.50	4	550	625	10	—
S	DMJ6531	131-012	6.0	0.30	0.50	4	550	625	10	4.0
S	DMJ3095	132-008	6.0	0.30	0.50	4	550	625	10	4.0
S	DMJ3297	295-025	6.0	0.30	0.50	4	550	625	10	—
S	DMJ3098	325-008	6.0	0.30	0.50	4	550	625	10	4.0
S	DMJ4783	325-012	6.0	0.30	0.50	4	550	625	10	4.0
S	DMJ3300	325-025	6.0	0.30	0.50	4	550	625	10	—
S	DMJ3092	378-012	6.0	0.30	0.50	4	550	625	10	4.0
S	DMJ3208	378-013	6.0	0.30	0.50	4	550	625	10	4.0
S	DMJ3303	396-025	6.0	0.30	0.50	4	550	625	10	—
S	DMJ3202	408-009	6.0	0.30	0.50	4	550	625	10	4.0
X	DMJ3295	130-025	6.5	0.15	0.30	9	550	650	10	—
X	DMJ4317	131-012	6.5	0.15	0.30	9	550	650	10	5.0
X	DMJ3096	132-008	6.5	0.15	0.30	9	550	650	10	5.0
X	DMJ3099	295-008	6.5	0.15	0.30	9	550	650	10	5.0
X	DMJ3101	295-012	6.5	0.15	0.30	9	550	650	10	5.0
X	DMJ3298	295-025	6.5	0.15	0.30	9	550	650	10	—
X	DMJ3105	325-008	6.5	0.15	0.30	9	550	650	10	5.0
X	DMJ3090	325-012	6.5	0.15	0.30	9	550	650	10	5.0
X	DMJ3301	325-025	6.5	0.15	0.30	9	550	650	10	—
X	DMJ3106	364-008	6.5	0.15	0.30	9	550	650	10	5.0
X	DMJ4760	364-012	6.5	0.15	0.30	9	550	650	10	5.0
X	DMJ3093	378-012	6.5	0.15	0.30	9	550	650	10	5.0
X	DMJ3209	378-013	6.5	0.15	0.30	9	550	650	10	5.0
X	DMJ3304	396-025	6.5	0.15	0.30	9	550	650	10	—
X	DMJ3203	408-009	6.5	0.15	0.30	9	550	650	10	5.0
Ku	DMJ3296	130-025	7.5	0.05	0.15	13	600	750	10	—
Ku	DMJ3081	131-012	7.5	0.05	0.15	13	550	750	10	5.0
Ku	DMJ3097	132-008	7.5	0.05	0.15	13	600	750	10	5.0
Ku	DMJ3100	295-008	7.5	0.05	0.15	13	600	750	10	5.0
Ku	DMJ3102	295-012	7.5	0.05	0.15	13	600	750	10	5.0
Ku	DMJ3299	295-025	7.5	0.05	0.15	13	600	750	10	—
Ku	DMJ3302	325-025	7.5	0.05	0.15	13	600	750	10	—
Ku	DMJ3107	364-008	7.5	0.05	0.15	13	600	750	10	5.0
Ku	DMJ3089	364-012	7.5	0.05	0.15	13	600	750	10	5.0
Ku	DMJ4705	378-012	7.5	0.05	0.15	13	600	750	10	5.0
Ku	DMJ3210	378-013	7.5	0.05	0.15	13	600	750	10	5.0
Ku	DMJ3246	396-025	7.5	0.05	0.15	13	600	750	10	—
Ku	DMJ3204	408-009	7.5	0.05	0.15	13	600	750	10	5.0

Notes:

1 N_d = 1.5 dB, L.O. = 1.0 mW, R_L = 100Ω

Band	Test Frequency (GHz)
S	3.1
X	9.4
Ku	16.0
Ka	34.9

2 R_s = R_t - R_b where R_t is the total resistance measured across the diode terminals and R_b is the barrier resistance (2.8Ω for a Schottky barrier diode measured at 10 mA. For multiple junction devices, the R_b would be 2.8Ω times the number of junctions between the diode terminals).

3 Electrical characteristics are specified for each junction except for those devices containing two or more junctions in series per arm. For these cases, the specification is for the arm.

4 Difference in forward voltage between leads within a pair or quad.

Silicon Beam-Lead and Chip Schottky Barrier Mixer Diodes

ALPHA IND/ SEMICONDUCTOR

Beam-Lead Pairs, N-Type, High Drive, 4-Junction

Frequency Band	Type Number	Outline	NF ⁽¹⁾ dB Max.	C _J 0V pF		R _s ⁽²⁾ — Ω Max.	V _F 1mA mV		ΔV _F ⁽⁴⁾ 1mA mV Max.	V _B 10μA V Min.
				Min.	Max.		Min.	Max.		
X	DMJ3180	407-029	—	0.15	0.30	14	1100	1400	15	8.0
Ku	DMJ3181	407-029	—	0.05	0.15	18	1100	1400	15	10.0

Beam-Lead Quad Rings, P-Type, Zero Bias

Frequency Band	Type Number	Outline	NF ⁽¹⁾ dB Max.	C _J 0V pF Typ.	R _s ⁽²⁾ — Ω Max.	V _F 1mA mV		ΔV _F 1mA mV Max.
						Min.	Max.	
Ku	DMH4383	132-002	—	0.10	40	100	250	15
Ku	DMH6570	295-002	—	0.10	40	100	250	15
Ku	DMH3156	309-002	—	0.10	40	100	250	15
Ku	DMH3157	325-002	—	0.10	40	100	250	15
Ku	DMH3158	364-002	—	0.10	40	100	250	15
Ku	DMH3159	399-003	—	0.10	40	100	250	15

Beam-Lead Quad Rings, N-Type, Low Drive

Frequency Band	Type Number	Outline	NF ⁽¹⁾ dB Max.	C _J 0V pF		R _s ⁽²⁾ — Ω Max.	V _F 1mA mV		ΔV _F ⁽⁴⁾ 1mA mV Max.
				Min.	Max.		Min.	Max.	
L	DMF4000	132-002	—	—	1.20	9	225	350	15
L	DMF4792	313-002	—	—	1.20	9	225	350	15
L	DMF4520	337-002	—	—	1.20	9	225	350	15
S	DMF5847A	132-002	6.0	0.30	0.50	3	225	300	15
S	DMF5847	132-002	6.5	0.30	0.50	7	225	300	15
S	DMF4384A	132-010	6.0	0.30	0.50	3	225	300	15
S	DMF4384	132-010	6.5	0.30	0.50	7	225	300	15
S	DMF6829A	294-003	6.0	0.30	0.50	3	225	300	15
S	DMF6829	294-003	6.5	0.30	0.50	7	225	300	15
S	DMF4549A	295-002	6.0	0.30	0.50	3	225	300	15
S	DMF4549	295-002	6.5	0.30	0.50	7	225	300	15
S	DMF4059A	325-002	6.0	0.30	0.50	3	225	300	15
S	DMF4059	325-002	6.5	0.30	0.50	7	225	300	15
X	DMF5829A	132-002	6.5	0.15	0.30	7	250	325	15
X	DMF5829	132-002	7.0	0.15	0.30	12	250	325	15
X	DMF4011A	294-003	6.5	0.15	0.30	7	250	325	15
X	DMF4011	294-003	7.0	0.15	0.30	12	250	325	15
X	DMF4745A	295-002	6.5	0.15	0.30	7	250	325	15
X	DMF4745	295-002	7.0	0.15	0.30	12	250	325	15
X	DMF5080A	325-002	6.5	0.15	0.30	7	250	325	15
X	DMF5080	325-002	7.0	0.15	0.30	12	250	325	15
X	DMF3074A	364-002	6.5	0.15	0.30	7	250	325	15

Notes:

1 N_d = 1.5 dB, L.O. = 1.0 mW, R_L = 100Ω

Band	Test Frequency (GHz)
S	3.1
X	9.4
Ku	16.0
Ka	34.9

- 2 R_s = R_t - R_b where R_t is the total resistance measured across the diode terminals and R_b is the barrier resistance (2.8Ω for a Schottky barrier diode measured at 10 mA. For multiple junction devices, the R_b would be 2.8Ω times the number of junctions between the diode terminals).
- 3 Electrical characteristics are specified for each junction except for those devices containing two or more junctions in series per arm. For these cases, the specification is for the arm.
- 4 Difference in forward voltage between leads within a pair or quad.

Silicon Beam-Lead and Chip Schottky Barrier Mixer Diodes

ALPHA IND/ SEMICONDUCTOR

Beam-Lead Quad Rings, N-Type, Low Drive (cont.)

Frequency Band	Type Number	Outline	NF ⁽¹⁾ dB Max.	C _J 0V pF		Rs ⁽²⁾ — Ω Max.	V _F 1mA mV		ΔV _F ⁽⁴⁾ 1mA mV Max.
				Min.	Max.		Min.	Max.	
X	DMF3074	364-002	7.0	0.15	0.30	12	250	325	15
Ku	DMF6395A	132-002	7.5	0.05	0.15	16	275	350	15
Ku	DMF6395	132-002	8.0	0.05	0.15	25	275	350	15
Ku	DMF4012A	294-003	7.5	0.05	0.15	16	275	350	15
Ku	DMF4012	294-003	8.0	0.05	0.15	25	275	350	15
Ku	DMF4574A	295-002	7.5	0.05	0.15	16	275	350	15
Ku	DMF4574	295-002	8.0	0.05	0.15	25	275	350	15
Ku	DMF3075A	364-002	7.5	0.05	0.15	16	275	350	15
Ku	DMF3075	364-002	8.0	0.05	0.15	25	275	350	15

Beam-Lead Quad Rings, N-Type, Medium Drive

Frequency Band	Type Number	Outline	NF ⁽¹⁾ dB Max.	C _J 0V pF		Rs ⁽²⁾ — Ω Max.	V _F 1mA mV		ΔV _F ⁽⁴⁾ 1mA mV Max.
				Min.	Max.		Min.	Max.	
L	DME6549	132-002	—	—	1.20	9	225	350	15
L	DME3027	313-002	—	—	1.20	9	225	350	15
L	DME3045	337-002	—	—	1.20	9	225	350	15
S	DME3038	132-002	6.0	0.30	0.50	4	300	400	15
S	DME3028	132-010	6.0	0.30	0.50	4	300	400	15
S	DME6561	294-003	6.0	0.30	0.50	4	300	400	15
S	DME3043	295-002	6.0	0.30	0.50	4	300	400	15
S	DME3044	325-002	6.0	0.30	0.50	4	300	400	15
X	DME4756	132-002	6.5	0.15	0.30	9	325	425	15
X	DME6562	294-003	6.5	0.15	0.30	9	325	425	15
X	DME4750	295-002	6.5	0.15	0.30	9	325	425	15
X	DME6557	325-002	6.5	0.15	0.30	9	325	425	15
X	DME4790	364-002	6.5	0.15	0.30	9	325	425	15
Ku	DME3039	132-002	7.5	0.05	0.15	16	350	450	15
Ku	DME6563	294-003	7.5	0.05	0.15	16	350	450	15
Ku	DME4541	295-002	7.5	0.05	0.15	16	350	450	15
Ku	DME3047	364-002	7.5	0.05	0.15	16	350	450	15

Beam-Lead Quad Rings, N-Type, High Drive, 4 Junction

Frequency Band	Type Number	Outline	NF ⁽¹⁾ dB Max.	C _J 0V pF		Rs ⁽²⁾ — Ω Max.	V _F 1mA mV		ΔV _F ⁽⁴⁾ 1mA mV Max.
				Min.	Max.		Min.	Max.	
S	DMJ4007	132-002	6.0	0.30	0.50	4	550	625	15
S	DMJ4502	294-003	6.0	0.30	0.50	4	550	625	15
S	DMJ3086	295-002	6.0	0.30	0.50	4	550	625	15
S	DMJ6668	325-002	6.0	0.30	0.50	4	550	625	15

Notes:

1 N_r = 1.5 dB, L.O. = 1.0 mW, R_L = 100Ω

Band	Test Frequency (GHz)
S	3.1
X	9.4
Ku	16.0
Ka	34.9

2 R_s = R_t - R_b where R_t is the total resistance measured across the diode terminals and R_b is the barrier resistance (2.8Ω for a Schottky barrier diode measured at 10mA. For multiple junction devices, the R_b would be 2.8Ω times the number of junctions between the diode terminals).

3 Electrical characteristics are specified for each junction except for those devices containing two or more junctions in series per arm. For these cases, the specification is for the arm.

4 Difference in forward voltage between leads within a pair or quad.

Silicon Beam-Lead and Chip Schottky Barrier Mixer Diodes

ALPHA IND/ SEMICONDUCTOR

Beam-Lead Quad Rings, N-Type, High Drive, 4 Junction (cont.)

Frequency Band	Type Number	Outline	NF ⁽¹⁾ dB Max.	C _J 0V pF		R _s ⁽²⁾ — Ω Max.	V _F 1mA mV		ΔV _F ⁽⁴⁾ 1mA mV Max.
				Min.	Max.		Min.	Max.	
X	DMJ6788	132-002	6.5	0.15	0.30	9	550	650	15
X	DMJ6990	294-003	6.5	0.15	0.30	9	550	650	15
X	DMJ3087	295-002	6.5	0.15	0.30	9	550	650	15
X	DMJ6669	325-002	6.5	0.15	0.30	9	550	650	15
X	DMJ3108	364-002	6.5	0.15	0.30	9	550	650	15
Ku	DMJ3082	132-002	7.5	0.05	0.15	13	600	750	15
Ku	DMJ6667	294-003	7.5	0.05	0.15	13	600	750	15
Ku	DMJ4397	295-002	7.5	0.05	0.15	13	600	750	15
Ku	DMJ3109	364-002	7.5	0.05	0.15	13	600	750	15

Beam-Lead Quad Rings, N-Type, Low Drive, 8 Junction

Frequency Band	Type Number	Outline	NF ⁽¹⁾ dB Max.	C _J 0V pF		R _s ⁽²⁾ — Ω Max.	V _F 1mA mV		ΔV _F ⁽⁴⁾ 1mA mV Max.
				Min.	Max.		Min.	Max.	
X	DMF3287A	294-021	—	0.15	0.30	6	450	700	20
X	DMF3287	294-021	—	0.15	0.30	14	450	700	20
Ku	DMF3288A	294-021	—	0.05	0.15	14	450	700	20
Ku	DMF3288	294-021	—	0.05	0.15	24	450	700	20

Beam-Lead Quad Rings, N-Type, Medium Drive, 8 Junction

Frequency Band	Type Number	Outline	NF ⁽¹⁾ dB Max.	C _J 0V pF		R _s ⁽²⁾ — Ω Max.	V _F 1mA mV		ΔV _F ⁽⁴⁾ 1mA mV Max.
				Min.	Max.		Min.	Max.	
X	DME3273	294-021	—	0.15	0.30	8	600	850	20
Ku	DME3274	294-021	—	0.05	0.15	18	600	850	20

Beam-Lead Quad Rings, N-Type, High Drive, 8 Junction

Frequency Band	Type Number	Outline	NF ⁽¹⁾ dB Max.	C _J 0V pF		R _s ⁽²⁾ — Ω Max.	V _F 1mA mV		ΔV _F ⁽⁴⁾ 1mA mV Max.
				Min.	Max.		Min.	Max.	
X	DMJ4708	132-020	—	0.15	0.30	14	1100	1400	20
X	DMJ4759	294-021	—	0.15	0.30	14	1100	1400	20
X	DMJ3094	295-020	—	0.15	0.30	14	1100	1400	20
X	DMJ4394	325-020	—	0.15	0.30	14	1100	1400	20
X	DMJ3112	364-020	—	0.15	0.30	14	1100	1400	20
Ku	DMJ3091	132-020	—	0.05	0.15	18	1100	1400	20
Ku	DMJ4771	294-021	—	0.05	0.15	18	1100	1400	20
Ku	DMJ4747	295-020	—	0.05	0.15	18	1100	1400	20
Ku	DMJ3113	364-020	—	0.05	0.15	18	1100	1400	20

Notes:

1 N_f = 1.5 dB, L.O. = 1.0 mW, R_L = 100Ω

Band	Test Frequency (GHz)
S	3.1
X	9.4
Ku	16.0
Ka	34.9

2 R_s = R_t - R_b where R_t is the total resistance measured across the diode terminals and R_b is the barrier resistance (2.8Ω for a Schottky barrier diode measured at 10 mA. For multiple junction devices, the R_b would be 2.8Ω times the number of junctions between the diode terminals).

3 Electrical characteristics are specified for each junction except for those devices containing two or more junctions in series per arm. For these cases, the specification is for the arm.

4 Difference in forward voltage between leads within a pair or quad.

Silicon Beam-Lead and Chip Schottky Barrier Mixer Diodes

ALPHA IND/ SEMICONDUCTOR

Beam-Lead Quad Rings, N-Type, High Drive, 12 Junction

Frequency Band	Type Number	Outline	NF ⁽¹⁾ dB Max.	C _J 0V pF		R _s ⁽²⁾ Ω Max.	V _F 1mA mV		ΔV _F ⁽⁴⁾ 1mA mV Max.
				Min.	Max.		Min.	Max.	
Ku	DMJ4766	132-022	—	0.05	0.15	21	1650	2250	25
Ku	DMJ6564	398-022	—	0.05	0.15	21	1650	2250	25

Beam-Lead Quad Bridges, N-Type, Low Drive

Frequency Band	Type Number	Outline	NF ⁽¹⁾ dB Max.	C _J 0V pF		R _s ⁽²⁾ Ω Max.	V _F 1mA mV		ΔV _F ⁽⁴⁾ 1mA mV Max.	V _B 10μA V Min.
				Min.	Max.		Min.	Max.		
L	DMF3059	132-004	—	—	1.20	9	225	350	15	1.0
L	DMF4540	337-004	—	—	1.20	9	225	350	15	1.0
S	DMF5848A	132-004	6.0	0.30	0.50	3	225	300	15	2.0
S	DMF5848	132-004	6.5	0.30	0.50	7	225	300	15	2.0
S	DMF3076A	294-004	6.0	0.30	0.50	3	225	300	15	2.0
S	DMF3076	294-004	6.5	0.30	0.50	7	225	300	15	2.0
S	DMF3067A	295-004	6.0	0.30	0.50	3	225	300	15	2.0
S	DMF3067	295-004	6.5	0.30	0.50	7	225	300	15	2.0
S	DMF3063A	325-004	6.0	0.30	0.50	3	225	300	15	2.0
S	DMF3063	325-004	6.5	0.30	0.50	7	225	300	15	2.0
X	DMF6288A	132-004	6.5	0.15	0.30	7	250	325	15	2.0
X	DMF6288	132-004	7.0	0.15	0.30	12	250	325	15	2.0
X	DMF3077A	294-004	6.5	0.15	0.30	7	250	325	15	2.0
X	DMF3077	294-004	7.0	0.15	0.30	12	250	325	15	2.0
X	DMF6558A	295-004	6.5	0.15	0.30	7	250	325	15	2.0
X	DMF6558	295-004	7.0	0.15	0.30	12	250	325	15	2.0
X	DMF4352A	325-004	6.5	0.15	0.30	7	250	325	15	2.0
X	DMF4352	325-004	7.0	0.15	0.30	12	250	325	15	2.0
X	DMF3079A	364-004	6.5	0.15	0.30	7	250	325	15	2.0
X	DMF3079	364-004	7.0	0.15	0.30	12	250	325	15	2.0
Ku	DMF6298A	132-004	7.5	0.05	0.15	16	275	350	15	2.0
Ku	DMF6298	132-004	8.0	0.05	0.15	25	275	350	15	2.0
Ku	DMF3078A	294-004	7.5	0.05	0.15	16	275	350	15	2.0
Ku	DMF3078	294-004	8.0	0.05	0.15	25	275	350	15	2.0
Ku	DMF6574A	295-004	7.5	0.05	0.15	16	275	350	15	2.0
Ku	DMF6574	295-004	8.0	0.05	0.15	25	275	350	15	2.0
Ku	DMF3080A	364-004	7.5	0.05	0.15	16	275	350	15	2.0
Ku	DMF3080	364-004	8.0	0.05	0.15	25	275	350	15	2.0

Notes:

1 N_f = 1.5 dB, L.O. = 1.0 mW, R_L = 100Ω

Band	Test Frequency (GHz)
S	3.1
X	9.4
Ku	16.0
Ka	34.9

- R_s = R_t - R_B where R_t is the total resistance measured across the diode terminals and R_B is the barrier resistance (2.8Ω for a Schottky barrier diode measured at 10mA. For multiple junction devices, the R_B would be 2.8Ω times the number of junctions between the diode terminals).
- Electrical characteristics are specified for each junction except for those devices containing two or more junctions in series per arm. For these cases, the specification is for the arm.
- Difference in forward voltage between leads within a pair or quad.

Silicon Beam-Lead and Chip Schottky Barrier Mixer Diodes

ALPHA IND/ SEMICONDUCTOR

Beam-Lead Quad Bridges, N-Type, Medium Drive

Frequency Band	Type Number	Outline	NF ⁽¹⁾ dB Max.	C _J 0V pF		R _s ⁽²⁾ — Ω Max.	V _F 1mA mV		ΔV _F ⁽⁴⁾ 1mA mV Max.	V _B 10μA V Min.
				Min.	Max.		Min.	Max.		
L	DME3042	132-004	—	—	1.20	9	300	450	15	2.0
S	DME3040	132-004	6.0	0.30	0.50	4	300	400	15	3.0
S	DME3029	294-004	6.0	0.30	0.50	4	300	400	15	3.0
S	DME3052	295-004	6.0	0.30	0.50	4	300	400	15	3.0
S	DME3032	325-004	6.0	0.30	0.50	4	300	400	15	3.0
X	DME4370	132-004	6.5	0.15	0.30	9	325	425	15	3.0
X	DME3030	294-004	6.5	0.15	0.30	9	325	425	15	3.0
X	DME6567	295-004	6.5	0.15	0.30	9	325	425	15	3.0
X	DME3033	325-004	6.5	0.15	0.30	9	325	425	15	3.0
X	DME3036	364-004	6.5	0.15	0.30	9	325	425	15	3.0
Ku	DME3041	132-004	7.5	0.05	0.15	16	350	450	15	3.0
Ku	DME3031	294-004	7.5	0.05	0.15	16	350	450	15	3.0
Ku	DME3053	295-004	7.5	0.05	0.15	16	350	450	15	3.0
Ku	DME3037	364-004	7.5	0.05	0.15	16	350	450	15	3.0

Beam-Lead Quad Bridges, N-Type, High Drive

Frequency Band	Type Number	Outline	NF ⁽¹⁾ dB Max.	C _J 0V pF		R _s ⁽²⁾ — Ω Max.	V _F 1mA mV		ΔV _F ⁽⁴⁾ 1mA mV Max.	V _B 10μA V Min.
				Min.	Max.		Min.	Max.		
S	DMJ6575	132-004	6.0	0.30	0.50	4	550	625	15	4.0
S	DMJ4312	294-004	6.0	0.30	0.50	4	550	625	15	4.0
S	DMJ3114	295-004	6.0	0.30	0.50	4	550	625	15	4.0
S	DMJ3120	325-004	6.0	0.30	0.50	4	550	625	15	4.0
X	DMJ4313	132-004	6.5	0.15	0.30	9	550	650	15	5.0
X	DMJ3088	294-004	6.5	0.15	0.30	9	550	650	15	5.0
X	DMJ3115	295-004	6.5	0.15	0.30	9	550	650	15	5.0
X	DMJ3121	325-004	6.5	0.15	0.30	9	550	650	15	5.0
X	DMJ3122	364-004	6.5	0.15	0.30	9	550	650	15	5.0
Ku	DMJ3083	132-004	7.5	0.05	0.15	13	600	750	15	5.0
Ku	DMJ4768	294-004	7.5	0.05	0.15	13	600	750	15	5.0
Ku	DMJ3116	295-004	7.5	0.05	0.15	13	600	750	15	5.0
Ku	DMJ3123	364-004	7.5	0.05	0.15	13	600	750	15	5.0

Beam-Lead Special Quads, N-Type, Low Drive

Frequency Band	Type Number	Outline	NF ⁽¹⁾ dB Max.	C _J 0V pF		R _s ⁽²⁾ — Ω Max.	V _F 1mA mV		ΔV _F ⁽⁴⁾ 1mA mV Max.	V _B 10μA V Min.
				Min.	Max.		Min.	Max.		
S	DMF4384A	132-010	6.0	0.30	0.50	3	225	300	15	—
S	DMF4384	132-010	6.5	0.30	0.50	7	225	300	15	—
S	DMF3251A	364-034	6.0	0.30	0.50	3	225	300	15	2.0

Notes:

1 N_f = 1.5 dB, L.O. = 1.0 mW, R_L = 100Ω

Band	Test Frequency (GHz)
S	3.1
X	9.4
Ku	16.0
Ka	34.9

2 R_s = R₁ - R_B where R₁ is the total resistance measured across the diode terminals and R_B is the barrier resistance (2.8Ω for a Schottky barrier diode measured at 10 mA. For multiple junction devices, the R_B would be 2.8Ω times the number of junctions between the diode terminals).

3 Electrical characteristics are specified for each junction except for those devices containing two or more junctions in series per arm. For these cases, the specification is for the arm.

4 Difference in forward voltage between leads within a pair or quad.

Silicon Beam-Lead and Chip Schottky Barrier Mixer Diodes

ALPHA IND/ SEMICONDUCTOR

Beam-Lead Special Quads, N-Type, Low Drive (cont.)

Frequency Band	Type Number	Outline	NF ⁽¹⁾ dB Max.	C _J 0V pF		R _s ⁽²⁾ — Ω Max.	V _F 1mA mV		ΔV _F ⁽⁴⁾ 1mA mV Max.	V _B 10μA V Min.
				Min.	Max.		Min.	Max.		
S	DMF3251	364-034	6.5	0.30	0.50	7	225	300	15	2.0
S	DMF3188A	397-034	6.0	0.30	0.50	3	225	300	15	2.0
S	DMF3188	397-034	6.5	0.30	0.50	7	225	300	15	2.0
X	DMF3252A	364-034	6.5	0.15	0.30	7	250	325	15	2.0
X	DMF3252	364-034	7.0	0.15	0.30	12	250	325	15	2.0
X	DMF3189A	397-034	6.5	0.15	0.30	7	250	325	15	2.0
X	DMF3189	397-034	7.0	0.15	0.30	12	250	325	15	2.0
Ku	DMF3253A	364-034	7.5	0.05	0.15	16	275	350	15	2.0
Ku	DMF3253	364-034	8.0	0.05	0.15	25	275	350	15	2.0
Ku	DMF3190A	397-034	7.5	0.05	0.15	16	275	350	15	2.0
Ku	DMF3190	397-034	8.0	0.05	0.15	25	275	350	15	2.0
Ku	DMF3214A	401-031	7.5	0.05	0.15	16	275	350	15	—
Ku	DMF3214	401-031	8.0	0.05	0.15	25	275	350	15	—
Ku	DMF3213A	401-040	7.5	0.05	0.15	16	275	350	15	2.0
Ku	DMF3213	401-040	8.0	0.05	0.15	25	275	350	15	2.0
Ku	DMF3243A	418-038	7.5	0.05	0.15	16	275	350	15	—
Ku	DMF3243	418-038	8.0	0.05	0.15	25	275	350	15	—

Beam-Lead Special Quads, N-Type, Medium Drive

Frequency Band	Type Number	Outline	NF ⁽¹⁾ dB Max.	C _J 0V pF		R _s ⁽²⁾ — Ω Max.	V _F 1mA mV		ΔV _F ⁽⁴⁾ 1mA mV Max.	V _B 10μA V Min.
				Min.	Max.		Min.	Max.		
S	DME3028	132-010	6.0	0.30	0.50	4	300	400	15	—
S	DME3254	364-034	6.0	0.30	0.50	4	300	400	15	3.0
S	DME3191	397-034	6.0	0.30	0.50	4	300	400	15	3.0
X	DME3255	364-034	6.5	0.15	0.30	9	325	425	15	3.0
X	DME3192	397-034	6.5	0.15	0.30	9	325	425	15	3.0
Ku	DME3256	364-034	7.5	0.05	0.15	16	350	450	15	3.0
Ku	DME3178	397-034	7.5	0.05	0.15	16	350	450	15	3.0
Ku	DME3285	401-031	7.5	0.05	0.15	16	350	450	15	—
Ku	DME3281	401-040	7.5	0.05	0.15	16	350	450	15	3.0
Ku	DME3261	418-038	7.5	0.05	0.15	16	350	450	15	—

Beam-Lead Special Quads, N-Type, High Drive

Frequency Band	Type Number	Outline	NF ⁽¹⁾ dB Max.	C _J 0V pF		R _s ⁽²⁾ — Ω Max.	V _F 1mA mV		ΔV _F ⁽⁴⁾ 1mA mV Max.	V _B 10μA V Min.
				Min.	Max.		Min.	Max.		
S	DMJ6708	132-010	6.0	0.30	0.50	4	550	625	15	—
S	DMJ3257	364-034	6.0	0.30	0.50	4	550	625	15	4.0
S	DMJ3193	397-034	6.0	0.30	0.50	4	550	625	15	4.0

Notes:

1 N_i = 1.5 dB, L.O. = 1.0 mW, R_i = 100Ω

Band	Test Frequency (GHz)
S	3.1
X	9.4
Ku	16.0
Ka	34.9

2 R_s = R_t - R_b where R_t is the total resistance measured across the diode terminals and R_b is the barrier resistance (2.8Ω for a Schottky barrier diode measured at 10mA. For multiple junction devices, the R_b would be 2.8Ω times the number of junctions between the diode terminals).

3 Electrical characteristics are specified for each junction except for those devices containing two or more junctions in series per arm. For these cases, the specification is for the arm.

4 Difference in forward voltage between leads within a pair or quad.

Silicon Beam-Lead and Chip Schottky Barrier Mixer Diodes

ALPHA IND/ SEMICONDUCTOR

Beam-Lead Special Quads, N-Type, High Drive

Frequency Band	Type Number	Outline	NF ⁽¹⁾ dB Max.	C _J 0V pF		R _s ⁽²⁾ — Ω Max.	V _F 1mA mV		ΔV _F ⁽⁴⁾ 1mA mV Max.	V _B 10μA V Min.
				Min.	Max.		Min.	Max.		
X	DMJ3258	364-034	6.5	0.15	0.30	9	550	650	15	5.0
X	DMJ3194	397-034	6.5	0.15	0.30	9	550	650	15	5.0
Ku	DMJ3259	364-034	7.5	0.05	0.15	13	600	750	15	5.0
Ku	DMJ3195	397-034	7.5	0.05	0.15	13	600	750	15	5.0
Ku	DMJ3305	401-031	7.5	0.05	0.15	13	600	750	15	—
Ku	DMJ3306	401-040	7.5	0.05	0.15	13	600	750	15	5.0
Ku	DMJ3262	418-038	7.5	0.05	0.15	13	600	750	15	—

Chips, P-Type, Low Drive, Low 1/f Noise (6.0 dB Max.)

Frequency Band	Type Number	Outline	NF ⁽¹⁾ dB Max.	C _J 0V pF		R _s ⁽²⁾ — Ω Max.	V _F 1mA mV		V _B 10μA V Min.
				Min.	Max.		Min.	Max.	
X	CMB7602	270-804	7.0	0.12	0.24	18	200	300	2.0
Ku	CMB7601	270-804	7.5	0.08	0.16	25	200	350	2.0

Chips, N-Type, Low Drive

Frequency Band	Type Number	Outline	NF ⁽¹⁾ dB Max.	C _J 0V pF		R _s ⁽²⁾ — Ω Max.	V _F 1mA mV		V _B 10μA V Min.
				Min.	Max.		Min.	Max.	
S	DMG6412A	270-805	6.0	0.15	0.30	8	200	300	2.0
S	DMG6412	270-805	6.5	0.15	0.30	8	200	300	2.0
X	DMG6413B	270-805	6.0	0.12	0.24	12	200	300	2.0
X	DMG6413A	270-805	6.5	0.12	0.24	12	200	300	2.0
Ku	DMG6414B	270-805	6.5	0.08	0.16	16	200	350	2.0
Ku	DMG6414A	270-805	7.0	0.08	0.16	16	200	350	2.0
K	DMG7599	270-805	9.0	0.05	0.10	22	200	350	2.0
Ka	DMG6415	270-805	10.0	0.02	0.07	35	200	350	2.0



SENSITIVE ELECTRONIC DEVICES

Notes:

1 N_t = 1.5 dB, L.O. = 1.0 mW, R_L = 100Ω

Band	Test Frequency (GHz)
S	3.1
X	9.4
Ku	16.0
K	24.0
Ka	34.9

- 2 R_s = R_t - R_B where R_t is the total resistance measured across the diode terminals and R_B is the barrier resistance (2.8Ω for a Schottky barrier diode measured at 10 mA. For multiple junction devices, the R_B would be 2.8Ω times the number of junctions between the diode terminals).
- 3 Electrical characteristics are specified for each junction except for those devices containing two or more junctions in series per arm. For these cases, the specification is for the arm.
- 4 Difference in forward voltage between leads within a pair or quad.