

Product Summary

$V_{(BR)DSS}$	$R_{DS(ON)}$ max	I_D max $T_A = +25^\circ\text{C}$
-20V	45m Ω @ $V_{GS} = -4.5\text{V}$	-4.5A
	65m Ω @ $V_{GS} = -2.5\text{V}$	-3.8A

Description

This new generation MOSFET is designed to minimize the on-state resistance ($R_{DS(on)}$), and yet maintain superior switching performance, making it ideal for high-efficiency power management applications.

Applications

- General Purpose Interfacing Switch
- Power Management Functions

Features and Benefits

- Low On-Resistance
- Low Gate Threshold Voltage
- Low Input Capacitance
- **Totally Lead-Free & Fully RoHS Compliant (Notes 1 & 2)**
- **Halogen and Antimony Free. "Green" Device (Note 3)**
- **Qualified to AEC-Q101 Standards for High Reliability**

Mechanical Data

- Case: SOT26
- Case Material: Molded Plastic, "Green" Molding Compound. UL Flammability Classification Rating 94V-0
- Moisture Sensitivity: Level 1 per J-STD-020
- Terminal Connections: See Diagram
- Terminals: Finish — Matte Tin Annealed over Copper Leadframe. Solderable per MIL-STD-202, Method 208 (63)
- Weight: 0.015 grams (Approximate)



Top View

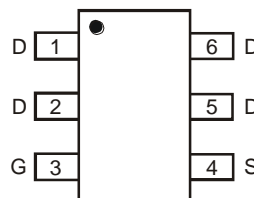

Top View
Pin-Out

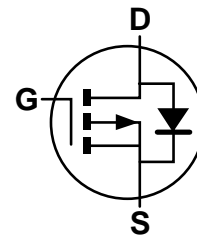

Equivalent Circuit

Ordering Information (Note 4)

Part Number	Case	Packaging
DMP2066LVT-7	SOT26	3,000/Tape & Reel
DMP2066LVT-13	SOT26	10,000/Tape & Reel

- Notes:
1. No purposely added lead. Fully EU Directive 2002/95/EC (RoHS) & 2011/65/EU (RoHS 2) compliant.
 2. See http://www.diodes.com/quality/lead_free.html for more information about Diodes Incorporated's definitions of Halogen- and Antimony-free, "Green" and Lead-free.
 3. Halogen- and Antimony-free "Green" products are defined as those which contain <900ppm bromine, <900ppm chlorine (<1500ppm total Br + Cl) and <1000ppm antimony compounds. For packaging details, go to our website at <http://www.diodes.com>.
 4. For packaging details, go to our website at <http://www.diodes.com/products/packages.html>.

Marking Information

SOT26

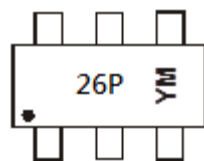

Shanghai A/T Site

26P = Product Type Marking Code
 YM = Date Code Marking for SAT (Shanghai Assembly/ Test site)
 Y or Y = Year (ex: A = 2013)
 M = Month (ex: 9 = September)

Date Code Key

Year	2011	2012	2013	2014	2015	2016	2017
Code	Y	Z	A	B	C	D	E

Month	Jan	Feb	Mar	Apr	May	Jun	Jul	Aug	Sep	Oct	Nov	Dec
Code	1	2	3	4	5	6	7	8	9	O	N	D

Maximum Ratings (@T_A = +25°C, unless otherwise specified.)

Characteristic	Symbol	Value	Unit	
Drain-Source Voltage	V _{DSS}	-20	V	
Gate-Source Voltage	V _{GSS}	±8	V	
Drain Current (Note 5) Continuous	I _D	T _A = +25°C	-4.5	A
		T _A = +70°C	-3.7	
Pulsed Drain Current (10µs pulse, duty cycle = 1%)	I _{DM}	-20	A	
Body-Diode Continuous Current (Note 5)	I _S	-2.0	A	

Thermal Characteristics (@T_A = +25°C, unless otherwise specified.)

Characteristic	Symbol	Value	Units
Total Power Dissipation (Note 5)	P _D	1.2	W
Thermal Resistance, Junction to Ambient (Note 5)	Steady State	100	°C/W
	t < 10s	74	
Total Power Dissipation (Note 6)	P _D	1.8	W
Thermal Resistance, Junction to Ambient (Note 6)	Steady State	70	°C/W
	t < 10s	46	
Operating and Storage Temperature Range	T _J , T _{STG}	-55 to +150	°C

Electrical Characteristics (@T_A = +25°C, unless otherwise specified.)

Characteristic	Symbol	Min	Typ	Max	Unit	Test Condition
STATIC PARAMETERS (Note 7)						
Drain-Source Breakdown Voltage	BV _{DSS}	-20	—	—	V	I _D = -250µA, V _{GS} = 0V
Zero Gate Voltage Drain Current	I _{DSS}	—	—	-1	µA	V _{DS} = -16V, V _{GS} = 0V
@ T _J = +55°C (Note 8)				-10		V _{DS} = -16V, V _{GS} = 0V
Zero Gate Voltage Drain Current	I _{DSS}	—	—	-100	µA	V _{DS} = -16V, V _{GS} = 0V
@ T _J = +150°C (Note 8)						
Gate-Body Leakage Current	I _{GSS}	—	—	±100	nA	V _{DS} = 0V, V _{GS} = ±8V
Gate Threshold Voltage	V _{GS(th)}	-0.4	—	-1.5	V	V _{DS} = V _{GS} , I _D = -250µA
Static Drain-Source On-Resistance	R _{DS(on)}	—	25 33	45 65	mΩ	V _{GS} = -4.5V, I _D = -4.5A V _{GS} = -2.5V, I _D = -3.8A
Static Drain-Source On-Resistance @ T _J = +125°C (Note 8)	R _{DS(on)}	—	—	72	mΩ	V _{GS} = -4.5V, I _D = -4.5A
Diode Forward Voltage	V _{SD}	-0.5	-0.72	-1.4	V	I _S = -2.1A, V _{GS} = 0V
On State Drain Current (Note 8)	I _{D(on)}	10	—	—	A	V _{DS} ≤ 5V, V _{GS} = 4.5V
DYNAMIC PARAMETERS (Note 8)						
Input Capacitance	C _{ISS}	—	1,496	2,990	pF	V _{DS} = -15V, V _{GS} = 0V f = 1.0MHz
Output Capacitance	C _{OSS}	—	130	260	pF	
Reverse Transfer Capacitance	C _{ISS}	—	116	230	pF	
Total Gate Charge	Q _G	—	14.4	25	nC	V _{DS} = -10V, V _{GS} = -4.5V, I _D = -4.5A
Gate-Source Charge	Q _{GS}	—	2.6	5		
Gate-Drain Charge	Q _{GD}	—	2.7	5.5		
Turn-On Delay Time	t _{d(on)}	—	8.5	30	ns	V _{DS} = -5V, V _{GS} = -4.5V, I _D = -1A, R _G = 6.0Ω
Rise Time	t _r	—	11	60		
Turn-Off Delay Time	t _{d(off)}	—	61	130		
Fall Time	t _f	—	25	100		

- Notes: 5. Device mounted on FR-4 substrate PC board, 2oz copper, with minimum recommended pad layout.
6. Device mounted on FR-4 substrate PC board, 2oz copper, with 1inch square copper plate.
7. Short duration pulse test used to minimize self-heating effect.
8. Guaranteed by design. Not subject to product testing.

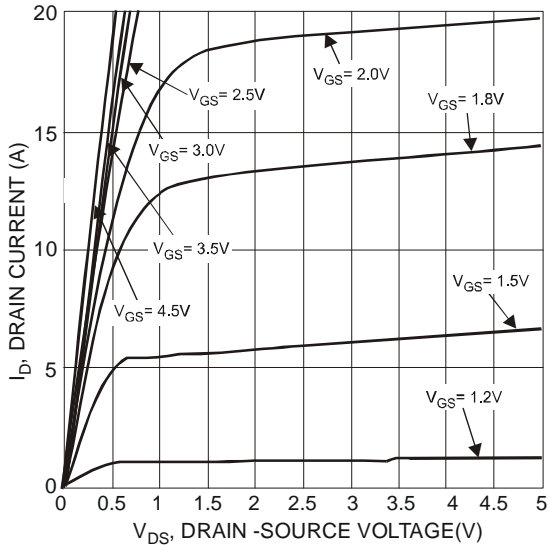

Figure 1 Typical Output Characteristics

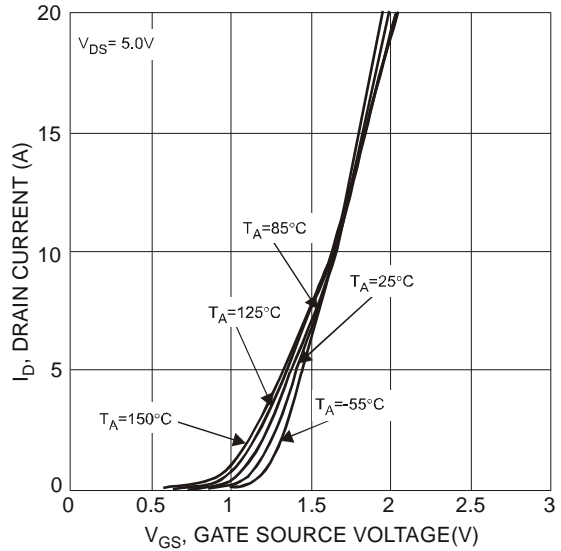

Figure 2 Typical Transfer Characteristics

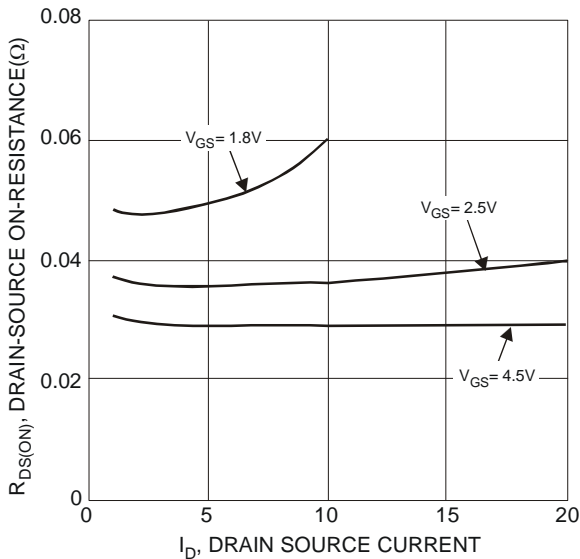

Figure 3 Typical On-Resistance vs. Drain Current and Gate Voltage

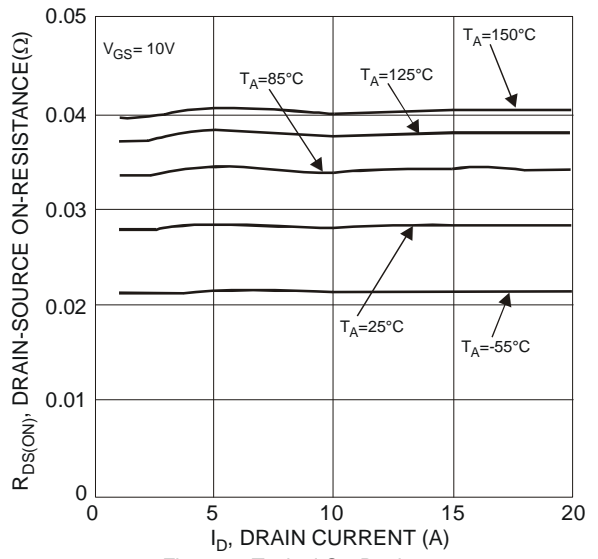

Figure 4 Typical On-Resistance vs. Drain Current and Temperature

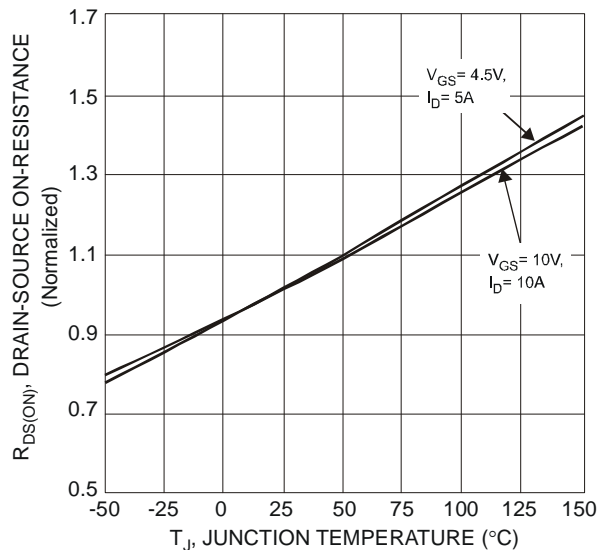

Figure 5 On-Resistance Variation with Temperature

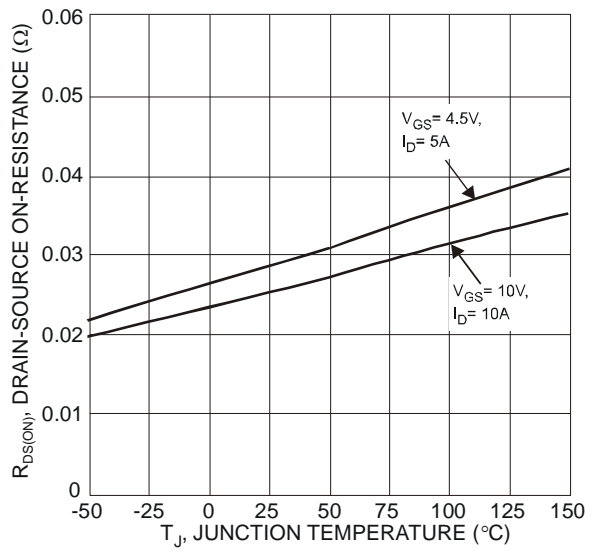

Figure 6 On-Resistance Variation with Temperature

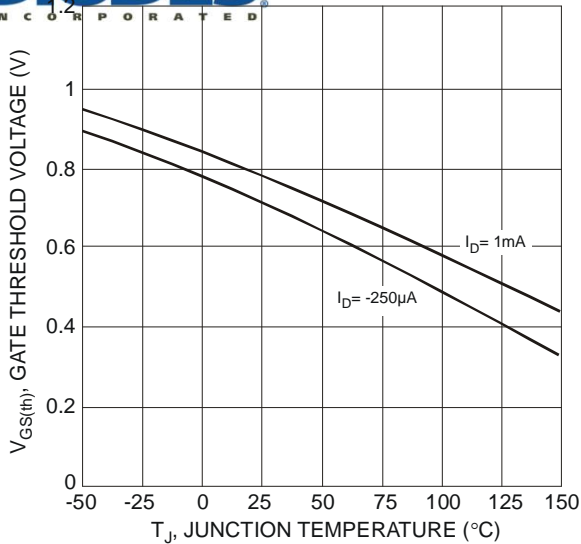

Figure 7 Gate Threshold Variation vs. Ambient Temperature

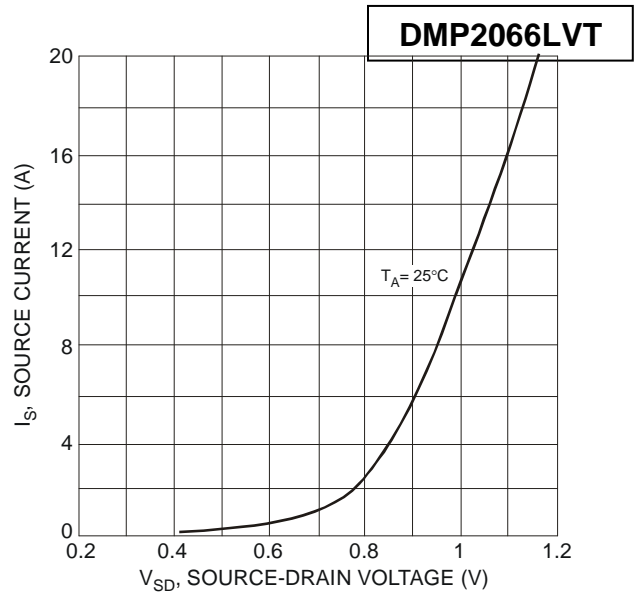

Figure 8 Diode Forward Voltage vs. Current

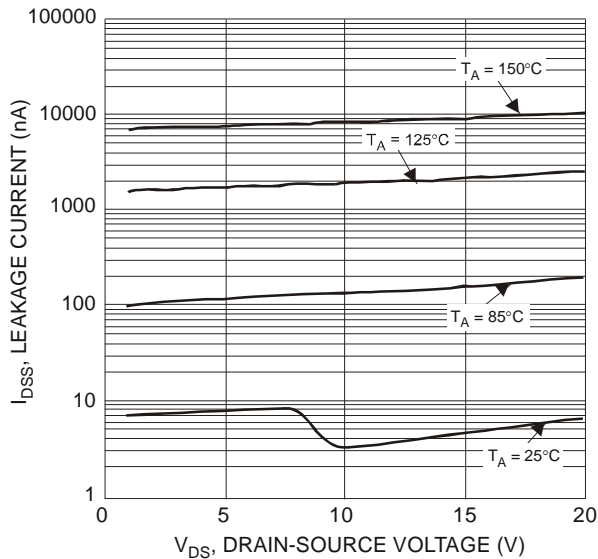

Figure 9 Typical Drain-Source Leakage Current vs. Voltage

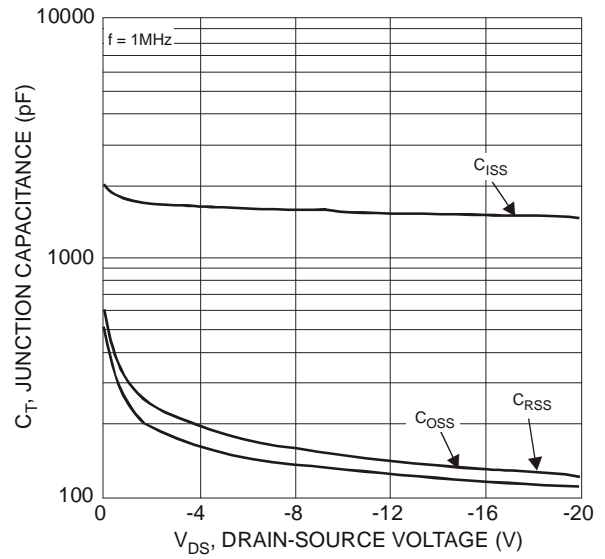

Figure 10 Typical Junction Capacitance

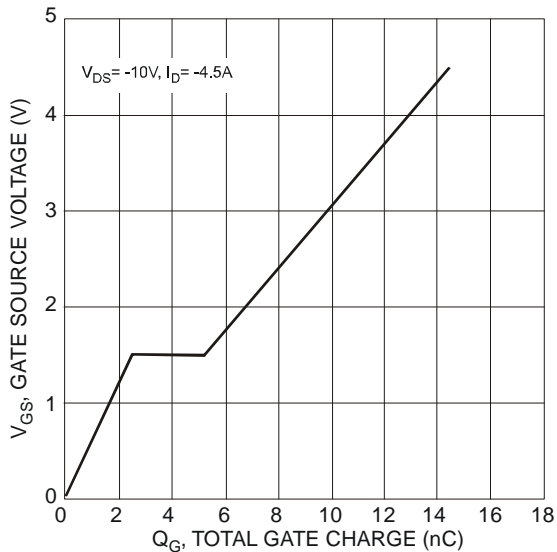
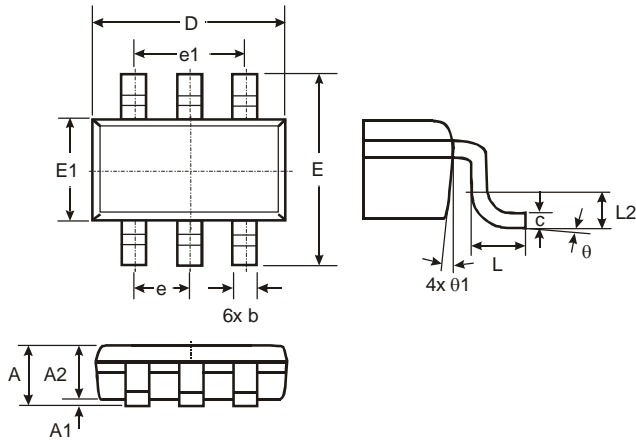

Figure 11 Gate Charge Characteristics

Package Outline Dimensions

TSOT26



TSOT26			
Dim	Min	Max	Typ
A	–	1.00	–
A1	0.01	0.10	–
A2	0.84	0.90	–
D	–	–	2.90
E	–	–	2.80
E1	–	–	1.60
b	0.30	0.45	–
c	0.12	0.20	–
e	–	–	0.95
e1	–	–	1.90
L	0.30	0.50	–
L2	–	–	0.25
theta	0°	8°	4°
theta1	4°	12°	–
All Dimensions in mm			

Suggested Pad Layout

TSOT26

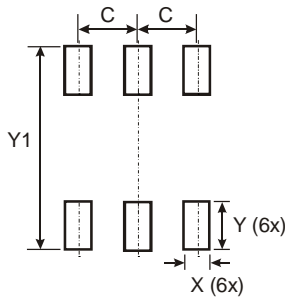

Dimensions	Value (in mm)
C	0.950
X	0.700
Y	1.000
Y1	3.199

IMPORTANT NOTICE

DIODES INCORPORATED MAKES NO WARRANTY OF ANY KIND, EXPRESS OR IMPLIED, WITH REGARDS TO THIS DOCUMENT, INCLUDING, BUT NOT LIMITED TO, THE IMPLIED WARRANTIES OF MERCHANTABILITY AND FITNESS FOR A PARTICULAR PURPOSE (AND THEIR EQUIVALENTS UNDER THE LAWS OF ANY JURISDICTION).

Diodes Incorporated and its subsidiaries reserve the right to make modifications, enhancements, improvements, corrections or other changes without further notice to this document and any product described herein. Diodes Incorporated does not assume any liability arising out of the application or use of this document or any product described herein; neither does Diodes Incorporated convey any license under its patent or trademark rights, nor the rights of others. Any Customer or user of this document or products described herein in such applications shall assume all risks of such use and will agree to hold Diodes Incorporated and all the companies whose products are represented on Diodes Incorporated website, harmless against all damages.

Diodes Incorporated does not warrant or accept any liability whatsoever in respect of any products purchased through unauthorized sales channel. Should Customers purchase or use Diodes Incorporated products for any unintended or unauthorized application, Customers shall indemnify and hold Diodes Incorporated and its representatives harmless against all claims, damages, expenses, and attorney fees arising out of, directly or indirectly, any claim of personal injury or death associated with such unintended or unauthorized application.

Products described herein may be covered by one or more United States, international or foreign patents pending. Product names and markings noted herein may also be covered by one or more United States, international or foreign trademarks.

This document is written in English but may be translated into multiple languages for reference. Only the English version of this document is the final and determinative format released by Diodes Incorporated.

LIFE SUPPORT

Diodes Incorporated products are specifically not authorized for use as critical components in life support devices or systems without the express written approval of the Chief Executive Officer of Diodes Incorporated. As used herein:

A. Life support devices or systems are devices or systems which:

1. are intended to implant into the body, or
2. support or sustain life and whose failure to perform when properly used in accordance with instructions for use provided in the labeling can be reasonably expected to result in significant injury to the user.

B. A critical component is any component in a life support device or system whose failure to perform can be reasonably expected to cause the failure of the life support device or to affect its safety or effectiveness.

Customers represent that they have all necessary expertise in the safety and regulatory ramifications of their life support devices or systems, and acknowledge and agree that they are solely responsible for all legal, regulatory and safety-related requirements concerning their products and any use of Diodes Incorporated products in such safety-critical, life support devices or systems, notwithstanding any devices- or systems-related information or support that may be provided by Diodes Incorporated. Further, Customers must fully indemnify Diodes Incorporated and its representatives against any damages arising out of the use of Diodes Incorporated products in such safety-critical, life support devices or systems.

Copyright © 2015, Diodes Incorporated

www.diodes.com