

Features

- Low On-Resistance
 - 100 mΩ @ $V_{GS} = -4.5V$
 - 120 mΩ @ $V_{GS} = -2.5V$
 - 160 mΩ @ $V_{GS} = -1.8V$
- Very Low Gate Threshold Voltage $V_{GS(th)} \leq 1V$
- Low Input Capacitance
- Fast Switching Speed
- Low Input/Output Leakage
- **Lead Free By Design/RoHS Compliant (Note 1)**
- **"Green" Device (Note 2)**
- **Qualified to AEC-Q 101 Standards for High Reliability**



TOP VIEW

SOT-323

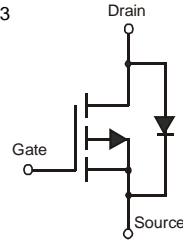

Internal Schematic

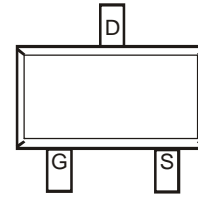

TOP VIEW

Mechanical Data

- Case: SOT-323
- Case Material: Molded Plastic, "Green" Molding Compound. UL Flammability Classification Rating 94V-0
- Moisture Sensitivity: Level 1 per J-STD-020D
- Terminals Connections: See Diagram Below
- Terminals: Finish - Matte Tin annealed over Alloy 42 leadframe. Solderable per MIL-STD-202, Method 208
- Marking Information: See Page 3
- Ordering Information: See Page 3
- Weight: 0.006 grams (approximate)

Maximum Ratings @ $T_A = 25^\circ C$ unless otherwise specified

Characteristic	Symbol	Value	Units
Drain-Source Voltage	V_{DSS}	-20	V
Gate-Source Voltage	V_{GSS}	± 12	V
Drain Current (Note 3)	I_D	$T_A = 25^\circ C$	-1.5
		$T_A = 70^\circ C$	-1.2
Pulsed Drain Current	I_{DM}	-10	A

Thermal Characteristics

Characteristic	Symbol	Value	Units
Total Power Dissipation (Note 3)	P_D	350	mW
Thermal Resistance, Junction to Ambient	$R_{\theta JA}$	360	$^\circ C/W$
Operating and Storage Temperature Range	T_J, T_{STG}	-55 to +150	$^\circ C$

- Notes:
1. No purposefully added lead.
 2. Diodes Inc.'s "Green" policy can be found on our website at http://www.diodes.com/products/lead_free/index.php.
 3. Device mounted on 1in² FR-4 PCB with 2 oz. Copper. $t \leq 10$ sec.

Electrical Characteristics @T_A = 25°C unless otherwise specified

Characteristic	Symbol	Min	Typ	Max	Unit	Test Condition
OFF CHARACTERISTICS (Note 4)						
Drain-Source Breakdown Voltage	BV _{DSS}	-20	—	—	V	V _{GS} = 0V, I _D = -250μA
Zero Gate Voltage Drain Current	I _{DSS}	—	—	-1.0	μA	V _{DS} = -20V, V _{GS} = 0V
Gate-Source Leakage	I _{GSS}	—	—	±100 ±800	nA	V _{GS} = ±8V, V _{DS} = 0V V _{GS} = ±12V, V _{DS} = 0V
ON CHARACTERISTICS (Note 4)						
Gate Threshold Voltage	V _{GS(th)}	-0.4	-0.6	-0.9	V	V _{DS} = V _{GS} , I _D = -250μA
Static Drain-Source On-Resistance	R _{DS(ON)}	—	75	100	mΩ	V _{GS} = -4.5V, I _D = -1.5A
			90	120		V _{GS} = -2.5V, I _D = -1.2A
			120	160		V _{GS} = -1.8V, I _D = -1A
Forward Transconductance	g _{FS}	—	4	—	S	V _{DS} = -10V, I _D = -1.5A
Diode Forward Voltage (Note 4)	V _{SD}	—	—	-1.0	V	V _{GS} = 0V, I _S = -1.0A
DYNAMIC CHARACTERISTICS						
Input Capacitance	C _{iss}	—	627	—	pF	V _{DS} = -10V, V _{GS} = 0V f = 1.0MHz
Output Capacitance	C _{oss}	—	64	—	pF	
Reverse Transfer Capacitance	C _{rss}	—	53	—	pF	

Notes: 4. Short duration pulse test used to minimize self-heating effect.

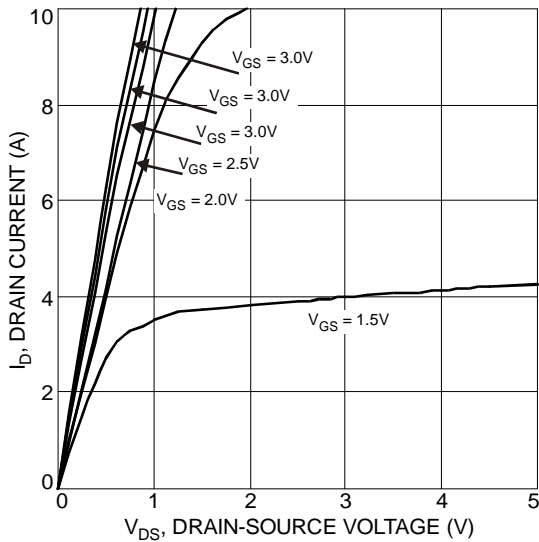

Fig. 1 Typical Output Characteristics

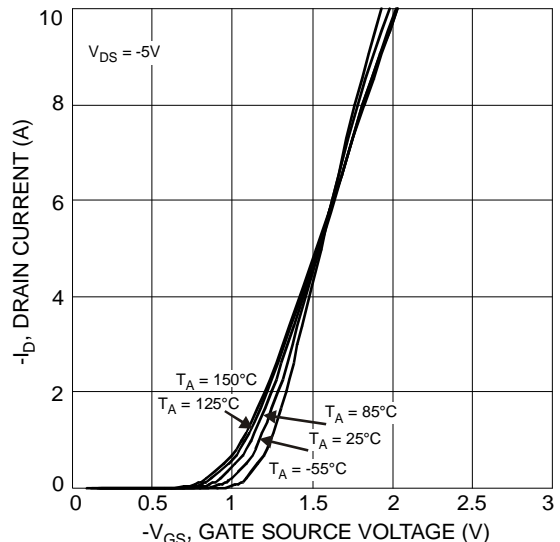

Fig. 2 Typical Transfer Characteristics

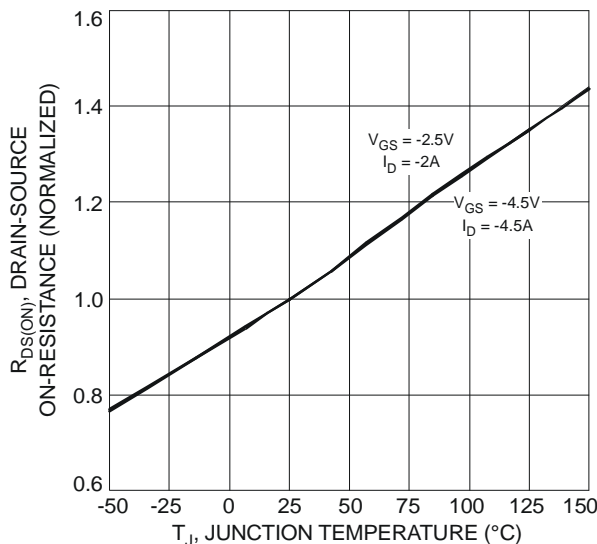

Fig. 3 On-Resistance Variation with Temperature

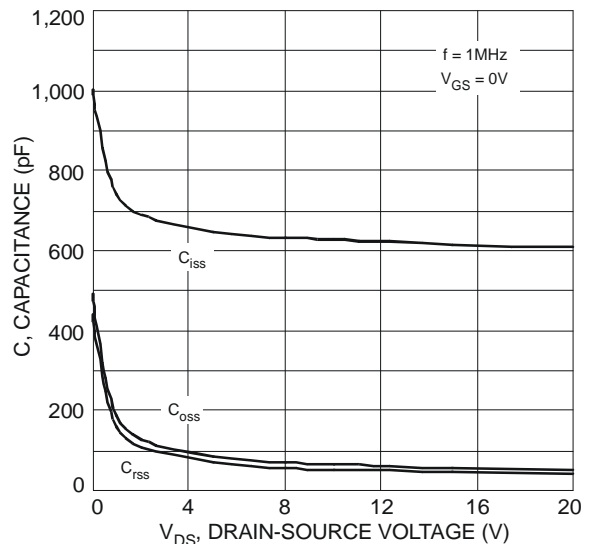

Fig. 4 Typical Capacitance

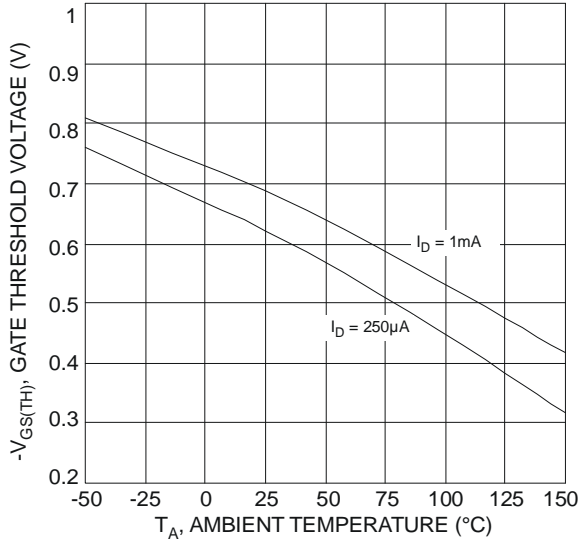

Fig. 5 Gate Threshold Variation vs. Ambient Temperature

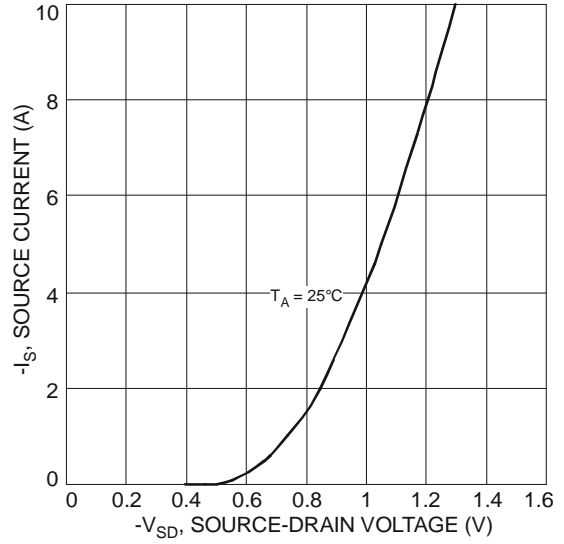

Fig. 6 Diode Forward Voltage vs. Current

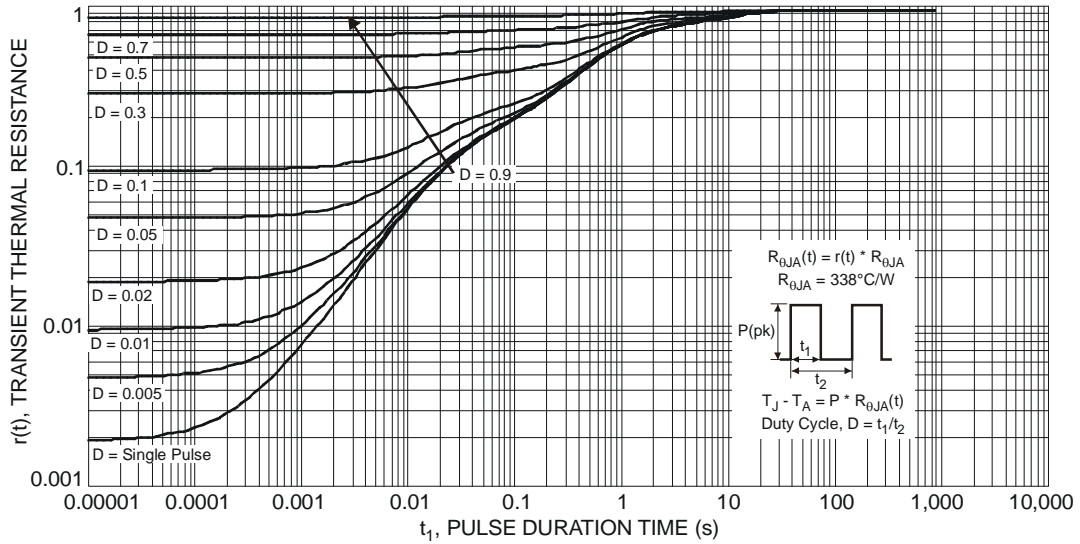

Fig. 7 Transient Thermal Response

Ordering Information (Note 5)

Part Number	Case	Packaging
DMP2160UW-7	SOT-323	3000/Tape & Reel

Notes: 5. For packaging details, go to our website at <http://www.diodes.com/datasheets/ap02007.pdf>.

Marking Information

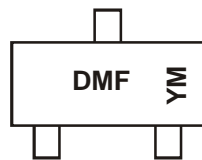

DMF = Marking Code
YM = Date Code Marking
Y = Year (ex: V = 2008)
M = Month (ex: 9 = September)

Date Code Key

Year Code	2008	2009	2010	2011	2012	2013	2014	2015				
Code	V	W	X	Y	Z	A	B	C				
Month Code	Jan	Feb	Mar	Apr	May	Jun	Jul	Aug	Sep	Oct	Nov	Dec
Code	1	2	3	4	5	6	7	8	9	O	N	D

Package Outline Dimensions

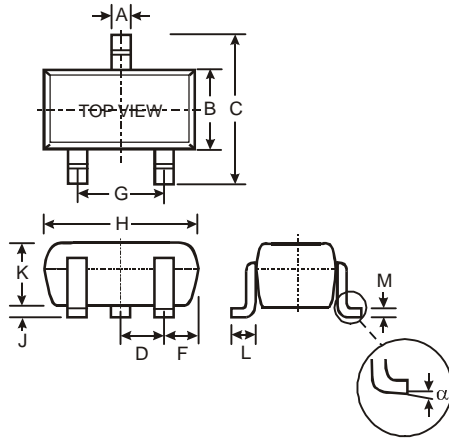

SOT-323			
Dim	Min	Max	Typ
A	0.25	0.40	0.30
B	1.15	1.35	1.30
C	2.00	2.20	2.10
D	-	-	0.65
F	0.30	0.40	0.425
G	1.20	1.40	1.30
H	1.80	2.20	2.15
J	0.0	0.10	0.05
K	0.90	1.00	1.00
L	0.25	0.40	0.30
M	0.10	0.18	0.11
α	0°	8°	-
All Dimensions in mm			

Suggested Pad Layout

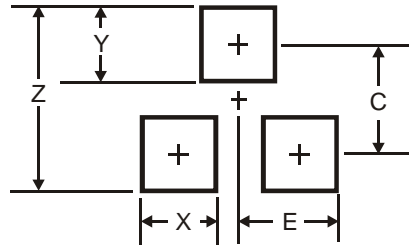

Dimensions	Value (in mm)
Z	2.8
X	0.7
Y	0.9
C	1.9
E	1.0

IMPORTANT NOTICE

Diodes Incorporated and its subsidiaries reserve the right to make modifications, enhancements, improvements, corrections or other changes without further notice to any product herein. Diodes Incorporated does not assume any liability arising out of the application or use of any product described herein; neither does it convey any license under its patent rights, nor the rights of others. The user of products in such applications shall assume all risks of such use and will agree to hold Diodes Incorporated and all the companies whose products are represented on our website, harmless against all damages.

LIFE SUPPORT

Diodes Incorporated products are not authorized for use as critical components in life support devices or systems without the expressed written approval of the President of Diodes Incorporated.