



# LIQUID CRYSTAL DISPLAY MODULE

## Product Specification

<b>CUSTOMER</b>	
<b>CUSTOMER PART NUMBER</b>	
<b>PRODUCT NUMBER</b>	<b>DMT028QVNTNT0S-1A</b>

Product Mgr	Design Eng
<b>Luo Luo</b>	<b>Eric Wan</b>
Date: 13-Mar-17	Date: 13-Mar-17

## TABLE OF CONTENTS

<b>1</b>	<b>MAIN FEATURES</b> .....	<b>4</b>
<b>2</b>	<b>MECHANICAL SPECIFICATION</b> .....	<b>5</b>
2.1	MECHANICAL CHARACTERISTICS.....	5
2.2	MECHANICAL DRAWING.....	6
<b>3</b>	<b>ELECTRICAL SPECIFICATION</b> .....	<b>7</b>
3.1	ABSOLUTE MAXIMUM RATINGS.....	7
3.2	ELECTRICAL CHARACTERISTICS.....	7
3.3	INTERFACE PIN ASSIGNMENT .....	8
3.4	BLOCK DIAGRAM .....	9
3.5	TIMING CHARACTERISTICS .....	10
3.6	COMMAND TABLE .....	12
3.7	POWER SEQUENCE .....	14
<b>4</b>	<b>OPTICAL SPECIFICATION</b> .....	<b>16</b>
4.1	OPTICAL CHARACTERISTICS .....	16
<b>5</b>	<b>BACKLIGHT SPECIFICATION</b> .....	<b>18</b>
5.1	LED DRIVING CONDITIONS .....	18
5.2	LED CIRCUIT .....	18
<b>6</b>	<b>QUALITY ASSURANCE SPECIFICATION</b> .....	<b>19</b>
6.1	DELIVERY INSPECTION STANDARDS .....	19
6.2	DEALING WITH CUSTOMER COMPLAINTS.....	25
<b>7</b>	<b>RELIABILITY SPECIFICATION</b> .....	<b>26</b>
7.1	RELIABILITY TESTS.....	26
<b>8</b>	<b>HANDLING PRECAUTIONS</b> .....	<b>27</b>

## REVISION RECORD

Rev.	Date	Page	Chapt.	Comment	ECN no.
1.0	13-Mar-17			Production Release	
1.1	07-July-17	7	3.2	Update Max. VCI and IOVCC to 3.3V	

## 1 MAIN FEATURES

ITEM	CONTENTS
Screen Size	2.8" Diagonal
Display Format	240 x RGB x 320 Dots
N° of Colour	262K
Overall Dimensions	49 mm (H) x 69 mm (V) x 2.15 mm (D)
Active Area	43.2 mm (H) x 57.6 mm (V)
LCD Type	TFT
Mode	IPS Transmissive / Normally Black
Viewing Direction	Full view
Interface	80-series CPU 8/9/16/18 bit selectable
Driver IC	ILI9341V or equivalent
Backlight Type	LED
Operating Temperature	-20°C ~ +70°C
Storage Temperature	-30°C ~ +80°C
RoHS compliant	2011/65/EU

## 2 MECHANICAL SPECIFICATION

### 2.1 MECHANICAL CHARACTERISTICS

---

ITEM	CHARACTERISTIC	UNIT
Display Format	240 x RGB x 320 Dots	Dots
Overall Dimensions	49 mm (H) x 69 mm (V) x 2.15 mm (D)	mm
Active Area	43.2 mm (H) x 57.6 mm (V)	mm
Dot Pitch	180 (H) x RGB x 180 (V)	μm
Weight	14	g

## 2.2 MECHANICAL DRAWING

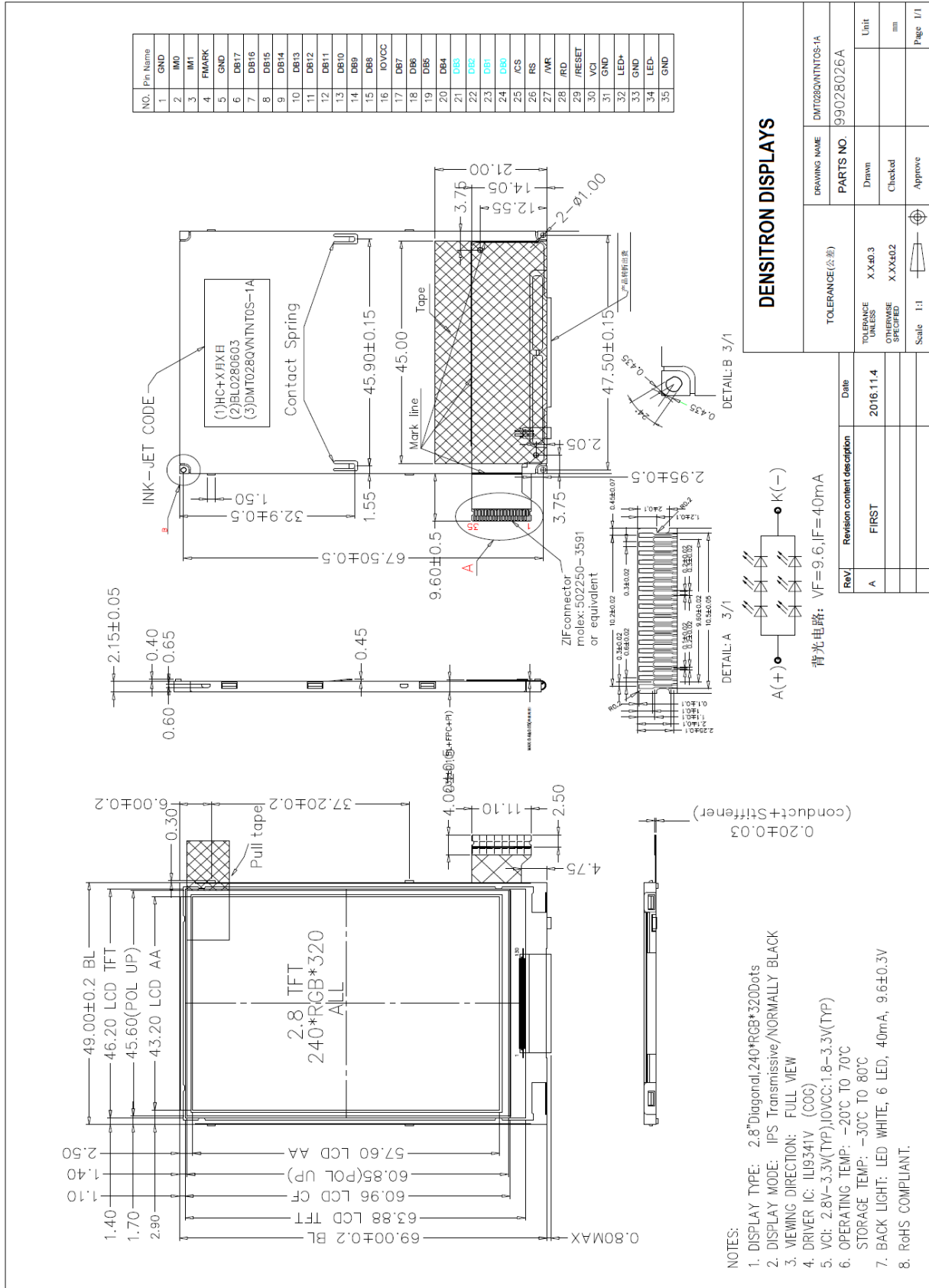

### 3 ELECTRICAL SPECIFICATION

#### 3.1 ABSOLUTE MAXIMUM RATINGS

Item	Symbol	Condition	Min	Max	Unit	Note
Power Supply Voltage	IOVCC, VCI	Ta=25°C	-0.3	4.6	V	
Operating Temperature	TOP		-20	70	°C	1
Storage Temperature	TST		-30	80	°C	1,2,3

Note 1. 90 % RH Max for Ta<50 °C, and 60% RH for Ta≥50°C.

Note 2. In case of below 0°C, the response time of liquid crystal (LC) becomes slower and the colour of panel becomes darker than normal one. Level of retardation depends on temperature, because of LC's characteristic.

Note 3. Only operation is guaranteed at operating temperature. Contrast, response time, another display quality are evaluated at +25°C.

#### 3.2 ELECTRICAL CHARACTERISTICS

Item	Symbol	Condition	Min	Typ	Max	Unit	Note
Supply Voltage	VCI		2.6	2.8	3.3	V	
	IOVCC		1.65	2.8	3.3	V	
Input Voltage for Logic	VIH		0.7xIOVCC	-	IOVCC	V	
	VIL		0	-	0.3xIOVCC	V	
Output Voltage for Logic	VOH		0.8xIOVCC	-	IOVCC	V	
	VOL		0	-	0.2xIOVCC	V	
Current Consumption	ICC		-	10	-	mA	1

Note 1: The specified power consumption is under the conditions of IOVCC=VCI=2.8V, FV=60Hz, whereas a Power dissipation check pattern below is displayed.

Black pattern

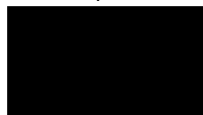

Active Area

### 3.3 INTERFACE PIN ASSIGNMENT

#### 3.3.1 LCM PIN ASSIGNMENT

Recommended connector: Molex 502250-3591

Pin No.	Symbol	Function				
1	GND	Ground				
2	IM0	IM1	IM0	Interface mode 80-series	DB Pin in use	
3	IM1				Register/Content	GRAM
					D[8:1]	D[17:10] D[8:1]
					D[17:10]	D[17:10]
					D[8:1]	D[17-0]
		1	1	CPU 9 bit I/F II	D[17:10]	D[17:9]
4	FMARK (TE)	Frame head pulse signal <i>(leave it Open if not used)</i>				
5	GND	Ground				
6	DB17	Data bus  <i>(connect unused pin(s) to VSS)</i>				
7	DB16					
8	DB15					
9	DB14					
10	DB13					
11	DB12					
12	DB11					
13	DB10					
14	DB9					
15	DB8					
16	IOVCC	Digital power supply				
17	DB7	Data bus  <i>(connect unused pin(s) to VSS)</i>				
18	DB6					
19	DB5					
20	DB4					
21	DB3					
22	DB2					
23	DB1					
24	DB0					
25	/CS (CSX)	Chip select signal active low				
26	RS (DCX)	Display data (RS=H) / Command selection (RS=L)				
27	/WR (WRX)	Write signal active low				
28	/RD (RDX)	Read signal active low				
29	/RESET (RESX)	Reset signal active low				
30	VCI	Analogue power supply				
31	GND	Ground				
32	LED+	LED power supply (+)				
33	GND	Ground				
34	LED-	LED power supply (-)				
35	GND	Ground				



### 3.4 BLOCK DIAGRAM

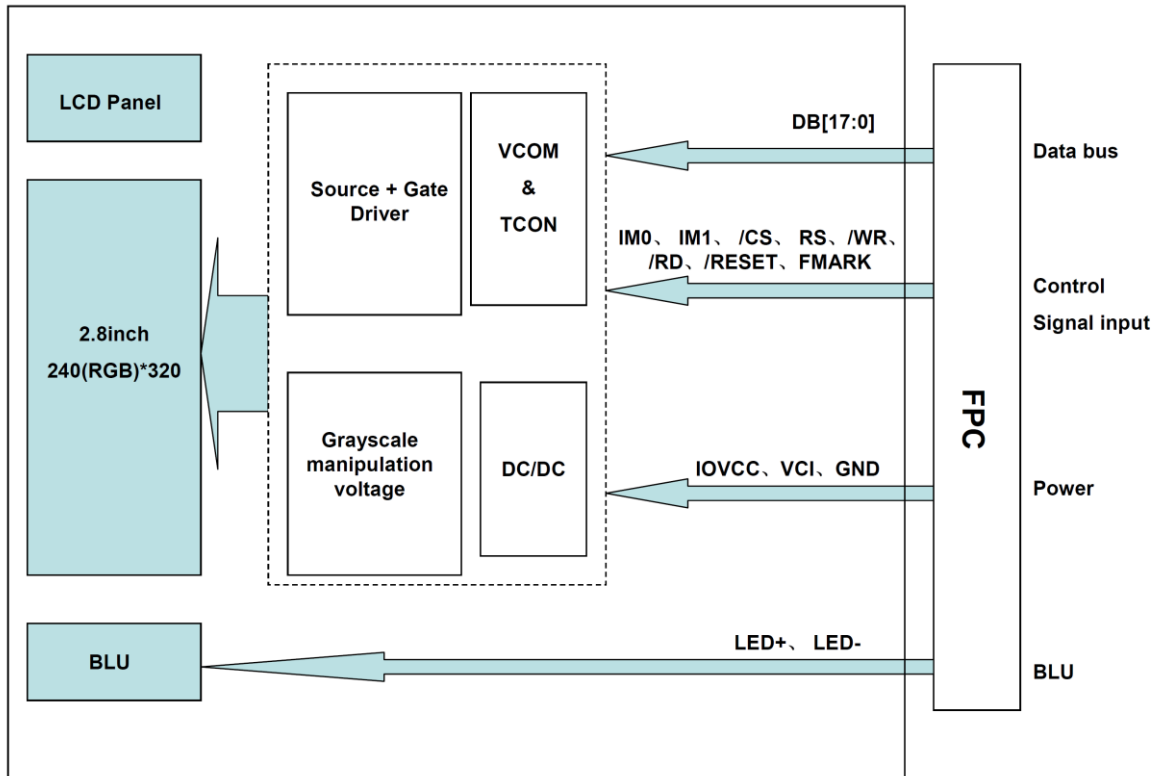

### 3.5 TIMING CHARACTERISTICS

Please refer to Ilitech IC ILI9341V datasheet for more information

#### 3.5.1 CPU 80-series Timing Characteristics (Interface II)

Item	Symbol	MIN	MAX	Unit	Remark
Address setup time	RS(DCX)	tast	0	-	Ns
Address hold time (Write/Read)		taht	0	-	ns
Chip select "H" pulse width	CS(CSX)	tchwh	0	-	ns
Chip select setup time (write)		tcs	15	-	ns
Chip select setup time (Read ID)		trcs	45	-	ns
Chip select setup time (Read FM)		trcsfm	355	-	ns
Chip select Wait time (Write/Read)		tcsf	10	-	ns
Write cycle		WR(WRX)	twc	66	-
Write Control pulse H duration	twrh		15	-	ns
Write Control pulse L duration	twrl		15	-	ns
Read cycle (FM)	RD(RDX (FM))	trcfm	450	-	ns
Read Control H duration (FM)		trdhfm	90	-	ns
Read Control L duration (FM)		trdlfm	355	-	ns
Read cycle (ID)	RD(RDX (ID))	trc	160	-	ns
Read Control H duration		trdh	90	-	ns
Read Control L duration		trdl	45	-	ns
Write data setup time	D[17:0], D[17:10] & D[8:1], D[17:10], D[17:9]	tdst	10	-	ns
Write data hold time		tdht	10	-	ns
Read access time		trat	-	40	ns
Read access time (FM)		tratfm	-	340	ns
Read output disable time		trod	20	80	ns

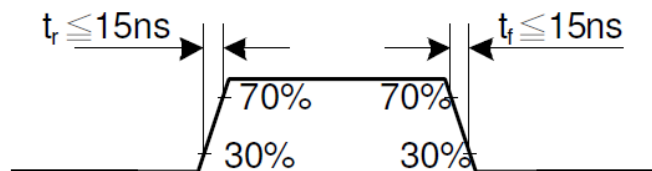

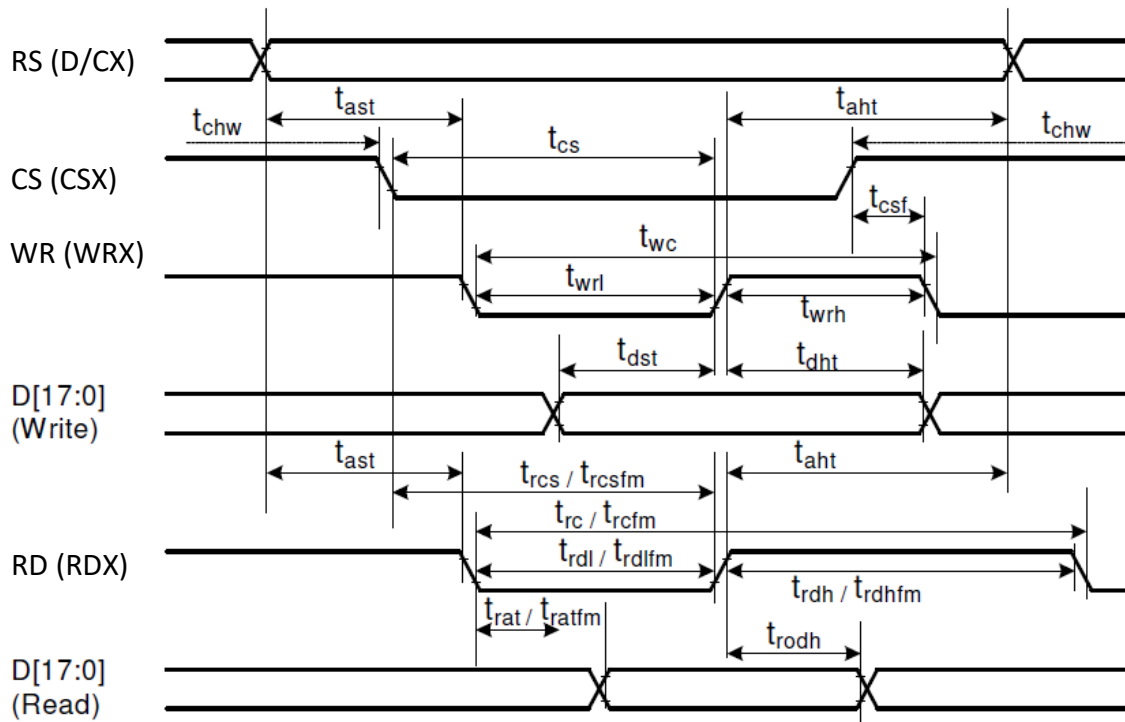

CS (CSX) timing:

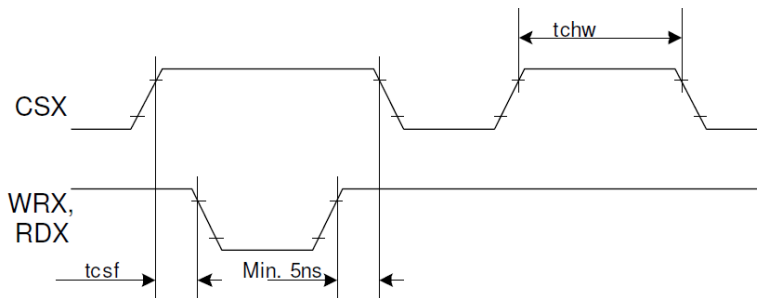

Write to read or read to write timings [WR (WRX), RD (RDX)]:

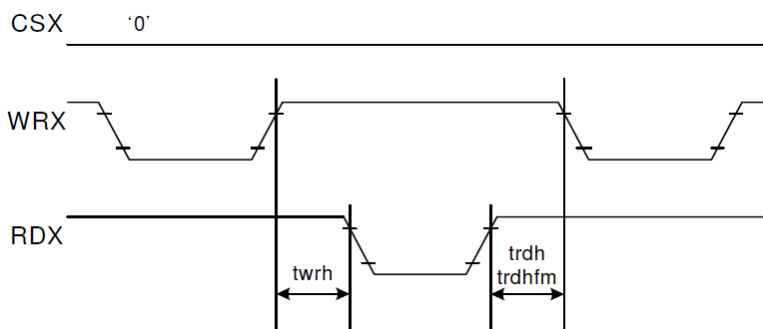

Note: Logic high and low levels are specified as 30% and 70% of IOVCC for Input signals.

### 3.6 COMMAND TABLE

Operational Code (HEX)	Function	Read/Write / Command	Number of Parameter	Parameters
00	No Operation	C	0	-
01	Software Reset	C	0	-
04	Read Display Identification Information	R	3	
09	Read Display Status	R	4	
0A	Read Display Power Mode	R	1	
0B	Read display MADCTL	R	1	
0C	Read Display Pixel Format	R	1	
0D	Read Display Image Mode	R	1	
0E	Read Display Signal Mode	R	1	
0F	Read Display Self Diagnostic Result	R	1	
10	Sleep In	C	0	-
11	Sleep Out	C	0	-
12	Partial Mode On	C	0	-
13	Normal Display Mode On	C	0	-
20	Display Inversion Off	C	0	-
21	Display Inversion On	C	0	-
26	Gamma Set	W	1	format: 1byte for curve selection
28	Display Off	C	0	-
29	Display On	C	0	-
2A	Column Address Set	W	4	format: 2 bytes for leftmost Column counter 2 bytes for rightmost Column counter
2B	Page Address Set	W	4	format: 2 bytes for top line pointer 2 bytes for bottom line pointer
2C	Memory Write	W	Any length	Successive video data stream Format in all colour modes
2E	Memory Read	R	Any length	Successive video data stream Format in all colour modes
30	Partial Area	W	4	format: 2 bytes for top line pointer 2 bytes for bottom line pointer

Operational Code (HEX)	Function	Read/Write / Command	Number of Parameter	Parameters
33	Vertical Scrolling Definition	W	6	format: 2 bytes for fixed area top line pointer 2 bytes for scrolling area height 2 bytes for fixed area bottom line pointer
34	Tearing Effect Line Off	C	0	
35	Tearing Effect Line On	W	1	1 byte for Tearing Effect Line Mode selection
36	Memory Data Access Control	W	1	1 byte for memory scan direction
37	Vertical Scrolling Start Address	W	2	2 bytes for line pointer
38	Idle Mode Off	C	0	-
39	Idle Mode On	C	0	-
3A	Interface Pixel Format	W	1	Refer to ILI9341 datasheet
DA	Read ID1	R	(1)	
DB	Read ID2	R	(1)	
DC	Read ID3	R	(1)	

### 3.7 POWER SEQUENCE

IOVCC and VCI can be applied in any order.

VCI and IOVCC can be powered down in any order.

During power off, if LCD is in the Sleep Out mode, VCI and IOVCC must be powered down minimum 120msec after RESET has been released.

During power off, if LCD is in the Sleep In mode, IOVCC or VCI can be powered down minimum 0msec after RESET has been released.

CS can be applied at any timing or can be permanently grounded. RESET has priority over CS.

Note 1: There will be no damage to the display module if the power sequences are not met.

Note 2: There will be no abnormal visible effects on the display panel during the Power On/Off Sequences.

Note 3: There will be no abnormal visible effects on the display between end of Power On Sequence and before receiving Sleep Out command. Also between receiving Sleep In command and Power Off Sequence.

Note 4: If RESET line is not held stable by host during Power On Sequence as defined in Sections 3.7.1 and 3.7.2, then it will be necessary to apply a Hardware Reset (RESET) after Host Power On Sequence is complete to ensure correct operation. Otherwise function is not guaranteed.

#### 3.7.1 Case 1 – RESET line is held High or Unstable by Host at Power ON

If RESET (RESX) line is held High or unstable by the host during Power On, then a Hardware Reset must be applied after both VCI and IOVCC have been applied – otherwise correct functionality is not guaranteed. There is no timing restriction upon this hardware reset.

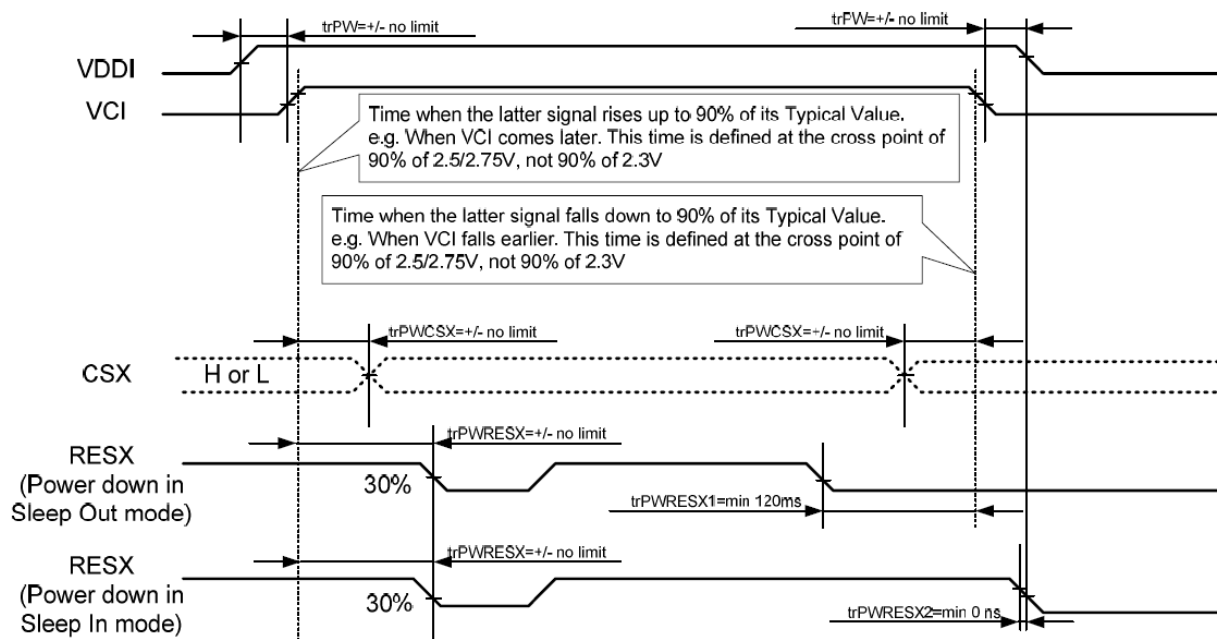

$trPWRESX1$  is applied to RESET (RESX) falling in the Sleep Out Mode

$trPWRESX2$  is applied to RESET (RESX) falling in the Sleep In Mode

### 3.7.2 Case 2 – RESET line is held Low by Host at Power ON

If RESET (RESX) line is held Low (and stable) by the host during Power On, then the RESET must be held low for minimum 10µsec after both VCI and IOVCC have been applied.

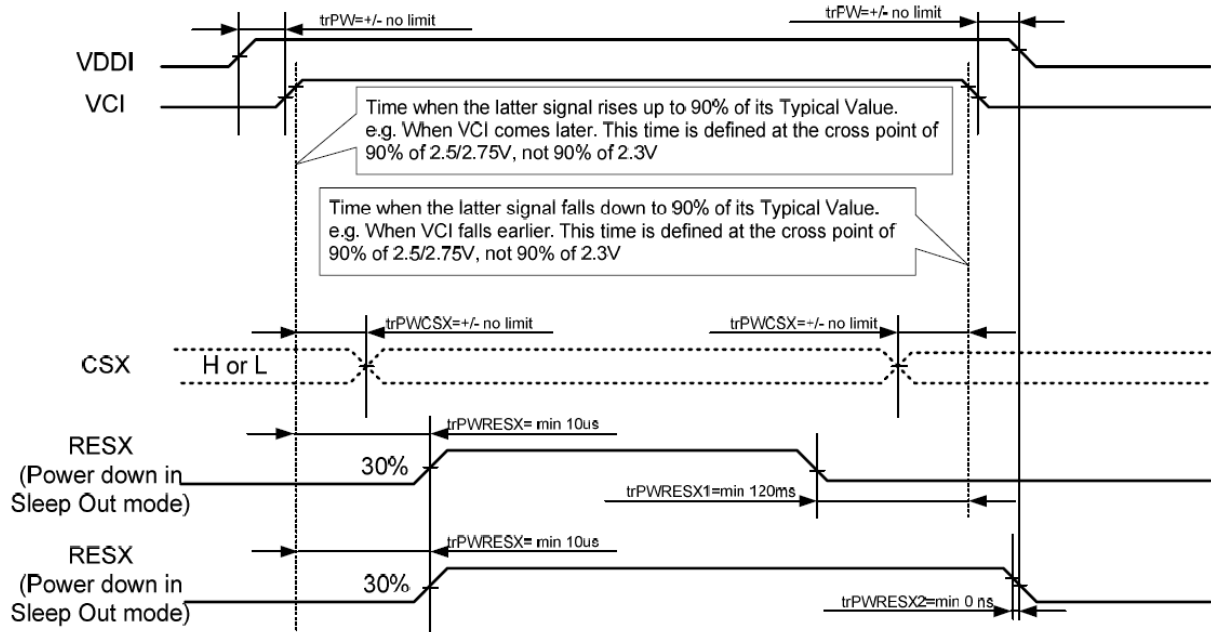

trPWRESX1 is applied to RESET (RESX) falling in the Sleep Out Mode

trPWRESX2 is applied to RESET (RESX) falling in the Sleep In Mode

### 3.7.3 Uncontrolled Power Off

The uncontrolled power off means a situation when e.g. there is removed a battery without the controlled power off sequence. There will not be any damages for the display module or the display module will not cause any damages for the host or lines of the interface. At an uncontrolled power off event, ILI9341 will force the display to blank and will not be any abnormal visible effects within 1 second on the display and remains blank until “Power On Sequence” activates.

For other settings and details please refer to ILI9341 data sheet.

## 4 OPTICAL SPECIFICATION

### 4.1 OPTICAL CHARACTERISTICS

Measuring instruments: LCD-5100, Eldim, Topcon BM-7

Driving condition: IOVCC = VCI = 2.8V, VSS = 0V

Backlight: IF=40mA

Measured temperature: Ta = 25° C

Item	Symbol	Condition	MIN	TYP	MAX	Unit	Note
Response Time	TR+TF	$\theta=\phi=0^\circ$ Normal Viewing Angle	-	35	-	ms	2
Contrast Ratio	CR		-	800	-		3
Viewing Angle	Left	CR ≥ 10	-	80	-	deg	4
	Right		-	80	-	deg	
	Up		-	80	-	deg	
	Down		-	80	-	deg	
Colour Chromaticity	Red	Rx	0.641	0.656	0.671	-	5
		Ry	0.312	0.327	0.342	-	
	Green	Gx	0.273	0.288	0.303	-	
		Gy	0.578	0.593	0.608	-	
	Blue	Bx	0.123	0.138	0.153	-	
		By	0.093	0.108	0.123	-	
	White	Wx	0.285	0.300	0.315	-	
		Wy	0.310	0.325	0.340	-	
Centre Brightness			500	-	-	cd/m <sup>2</sup>	6
Brightness Distribution			80	-	-	%	7

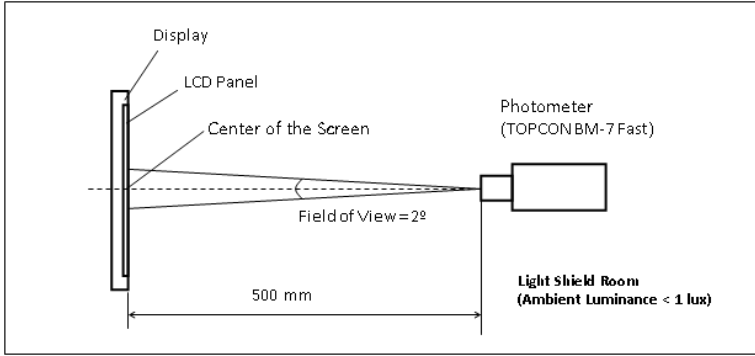
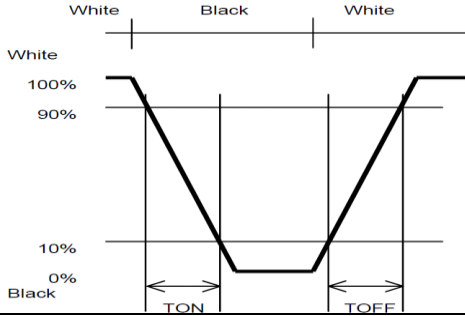
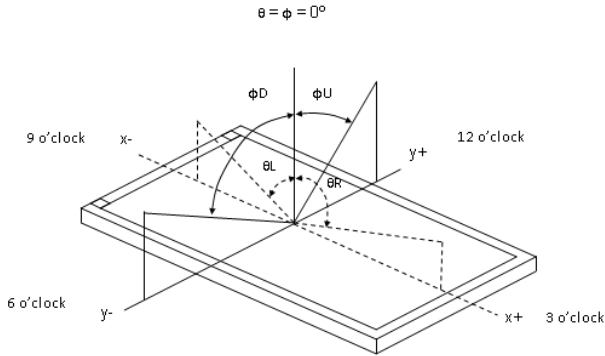

### 4.1.1 Test Method

Note	Item	Test method
1	Setup	<p>The display should be stabilised at a given temperature for 30 minutes to avoid abrupt temperature change during measuring. In order to stabilise the luminance, measurements should be executed after lighting the backlight for 30 minutes in a windless room.</p> 
2	Response time	<p>Measure output signal waveform by the luminance meter when raster of window pattern is changed from white to black and from black to white.</p> 
3	Contrast ratio	<p>Measure maximum brightness and minimum brightness at the centre of the screen by displaying raster or window pattern. Then calculate the ratio between these two values.</p> $\text{Contrast Ratio (CR)} = \frac{\text{Brightness of unselected position (white)}}{\text{Brightness of selected position (black)}}$
4	Viewing angle Horizontal $\theta$ Vertical $\phi$	<p>Move the luminance meter from right to left and up and down and determinate the angles where contrast ratio is 10</p> 
5	Colour chromaticity	Measure chromaticity coordinates x and y of CIE1931 colorimetric system
6	Centre brightness	Measure the brightness at the centre of the screen
7	Brightness distribution	<p>(Brightness distribution) = <math>100 \times B/A \%</math>  A: max. brightness of the 9 points  B: min. brightness of the 9 points</p>

## 5 BACKLIGHT SPECIFICATION

### 5.1 LED DRIVING CONDITIONS

Item	Symbol	Condition	Min	Typ	Max	Unit
Forward Current	IF	Ta=25 °C, VF=3.2V/LED	-	20*2	-	mA
Forward Voltage	VF	Ta= 25°C, IF= 20mA/LED	3.0*3	3.2*3	3.4*3	V
Power Consumption	PBL	Ta= 25°C, IL= 40mA	-	384	-	mW
Estimated Life of LED	LL	Ta= 25°C, IF= 40mA Note	-	50000	-	Hr
LED configuration	6 white LEDs (3 LEDs in one string and 2 groups in parallel)					

**Note:**

- The lifetime of the LED is defined as a period till the brightness of the LED decreases to the half of its initial value.
- This figure is given as a reference purpose only, and not a guarantee.
- This figure is estimated for an LED operating alone.  
The performance of an LED may differ when assembled as a monitor together with a TFT panel due to different environmental temperature.
- Estimated lifetime could vary on a different temperature and usually higher temperature could reduce the life significantly.

### 5.2 LED CIRCUIT

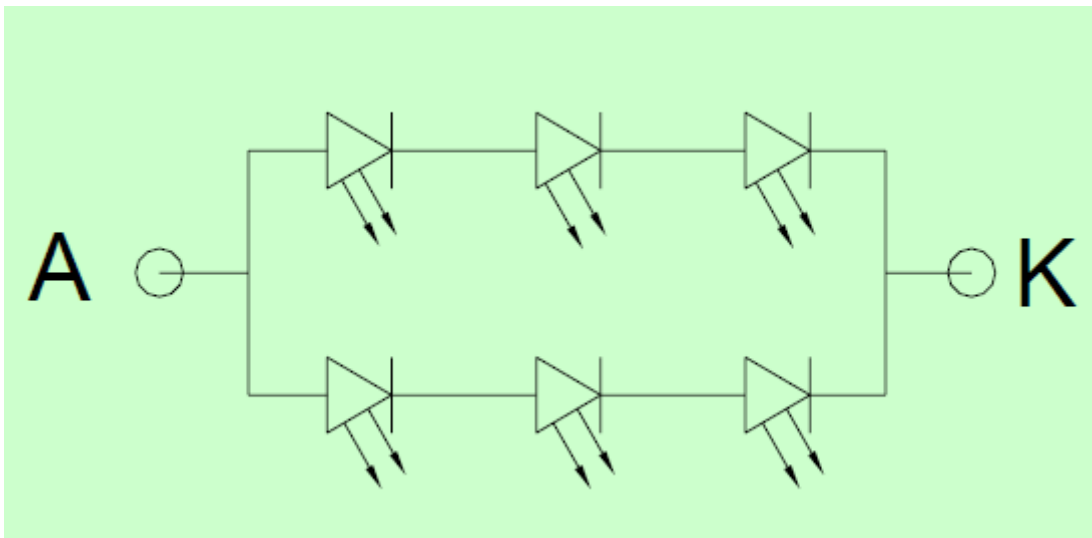

## 6 QUALITY ASSURANCE SPECIFICATION

### 6.1 DELIVERY INSPECTION STANDARDS

#### 6.1.1 Inspection Conditions

Inspection distance: 30 cm  $\pm$  2 cm  
Viewing angle:  $\pm 45^\circ$

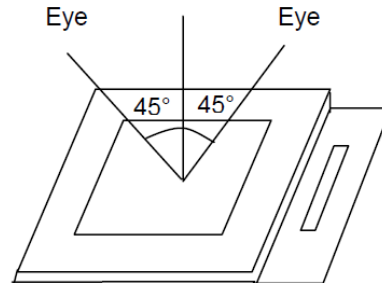

#### 6.1.2 Environmental Conditions

Ambient temperature: 25°C  $\pm$  5°C  
Ambient humidity: 65 $\pm$ 10% RH  
Ambient illumination: 300~700 lux

#### 6.1.3 Sampling Conditions

1. Lot size: quantity of shipment lot per model
2. Sampling method:

Sampling Plan		GB/T 2828-2003
		Normal inspection, Class II
AQL	Major Defect	0.65%
	Minor Defect	1.5%

No	Items to be inspected	Criteria	Classification of defects
1	Functional defects	1) No display, Open or miss line 2) Display abnormally, Short 3) Backlight no lighting, abnormal lighting. 4) TP no function	Major
2	Missing	Missing component	
3	Outline dimension	Overall outline dimension beyond the drawing is not allowed	
4	Color tone	Color unevenness, refer to limited sample	Minor
5	Soldering appearance	Good soldering , Peeling off is not allowed.	
6	LCD/Polarizer/TP	Black/White spot/line, scratch, crack, etc.	

## 6.1.4 Definition of Area

A zone: active area

B zone: viewing area

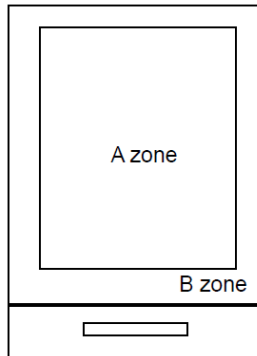

## 6.1.5 Basic Principle

A set of sample to indicate the limit of acceptable quality level shall be discussed should a dispute occur.

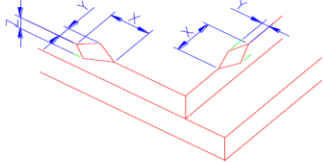
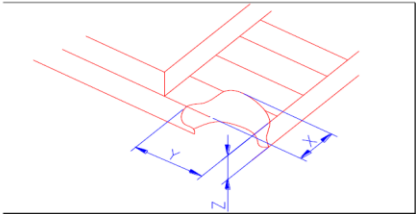
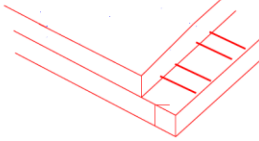

### 6.1.6 Inspection Criteria

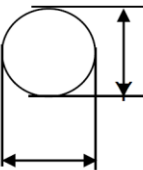
Number	Items	Criteria(mm)						
1.0 LCD Crack/Broken  NOTE: X: Length Y: Width Z: Height L: Length of ITO, T: Height of LCD	(1) The edge of LCD broken	 <table border="1" data-bbox="850 611 1334 741"> <thead> <tr> <th>X</th> <th>Y</th> <th>Z</th> </tr> </thead> <tbody> <tr> <td>≤3.0mm</td> <td>&lt;Inner border line of the seal</td> <td>≤T</td> </tr> </tbody> </table>	X	Y	Z	≤3.0mm	<Inner border line of the seal	≤T
	X	Y	Z					
	≤3.0mm	<Inner border line of the seal	≤T					
(2)LCD corner broken	 <table border="1" data-bbox="904 1021 1278 1106"> <thead> <tr> <th>X</th> <th>Y</th> <th>Z</th> </tr> </thead> <tbody> <tr> <td>≤3.0mm</td> <td>≤L</td> <td>≤T</td> </tr> </tbody> </table>	X	Y	Z	≤3.0mm	≤L	≤T	
X	Y	Z						
≤3.0mm	≤L	≤T						
(3) LCD crack	 <p style="text-align: center;">Crack Not allowed</p>							

Number	Items	Criteria (mm)																									
2.0	Spot defect  $\Phi = (X+Y)/2$	① light dot ( LCD/TP/Polarizer black/white spot , light dot, pinhole, dent, stain )																									
		<table border="1"> <thead> <tr> <th rowspan="2">Zone Size (mm)</th> <th colspan="3">Acceptable Qty</th> </tr> <tr> <th>A</th> <th>B</th> <th>C</th> </tr> </thead> <tbody> <tr> <td><math>\Phi \leq 0.10</math></td> <td colspan="3">Ignore</td> </tr> <tr> <td><math>0.10 &lt; \Phi \leq 0.20</math></td> <td colspan="3">3( distance <math>\geq 10\text{mm}</math>)</td> </tr> <tr> <td><math>0.20 &lt; \Phi \leq 0.25</math></td> <td colspan="3">2</td> </tr> <tr> <td><math>\Phi &gt; 0.25</math></td> <td colspan="3">0</td> </tr> </tbody> </table>	Zone Size (mm)	Acceptable Qty			A	B	C	$\Phi \leq 0.10$	Ignore			$0.10 < \Phi \leq 0.20$	3( distance $\geq 10\text{mm}$ )			$0.20 < \Phi \leq 0.25$	2			$\Phi > 0.25$	0				
		Zone Size (mm)		Acceptable Qty																							
			A	B	C																						
$\Phi \leq 0.10$	Ignore																										
$0.10 < \Phi \leq 0.20$	3( distance $\geq 10\text{mm}$ )																										
$0.20 < \Phi \leq 0.25$	2																										
$\Phi > 0.25$	0																										
② Dim spot ( LCD/TP/Polarizer dim dot, light leakage, dark spot )																											
<table border="1"> <thead> <tr> <th rowspan="2">Zone Size (mm)</th> <th colspan="3">Acceptable Qty</th> </tr> <tr> <th>A</th> <th>B</th> <th>C</th> </tr> </thead> <tbody> <tr> <td><math>\Phi \leq 0.1</math></td> <td colspan="3">Ignore</td> </tr> <tr> <td><math>0.10 &lt; \Phi \leq 0.20</math></td> <td colspan="3">3( distance <math>\geq 10\text{mm}</math>)</td> </tr> <tr> <td><math>0.20 &lt; \Phi \leq 0.30</math></td> <td colspan="3">2</td> </tr> <tr> <td><math>\Phi &gt; 0.30</math></td> <td colspan="3">0</td> </tr> </tbody> </table>	Zone Size (mm)	Acceptable Qty			A	B	C	$\Phi \leq 0.1$	Ignore			$0.10 < \Phi \leq 0.20$	3( distance $\geq 10\text{mm}$ )			$0.20 < \Phi \leq 0.30$	2			$\Phi > 0.30$	0						
Zone Size (mm)		Acceptable Qty																									
	A	B	C																								
$\Phi \leq 0.1$	Ignore																										
$0.10 < \Phi \leq 0.20$	3( distance $\geq 10\text{mm}$ )																										
$0.20 < \Phi \leq 0.30$	2																										
$\Phi > 0.30$	0																										
③ Polarizer accidented spot																											
<table border="1"> <thead> <tr> <th rowspan="2">Zone Size (mm)</th> <th colspan="3">Acceptable Qty</th> </tr> <tr> <th>A</th> <th>B</th> <th>C</th> </tr> </thead> <tbody> <tr> <td><math>\Phi \leq 0.2</math></td> <td colspan="3">Ignore</td> </tr> <tr> <td><math>0.3 &lt; \Phi \leq 0.5</math></td> <td colspan="3">2( distance <math>\geq 10\text{mm}</math>)</td> </tr> <tr> <td><math>\Phi &gt; 0.5</math></td> <td colspan="3">0</td> </tr> </tbody> </table>	Zone Size (mm)	Acceptable Qty			A	B	C	$\Phi \leq 0.2$	Ignore			$0.3 < \Phi \leq 0.5$	2( distance $\geq 10\text{mm}$ )			$\Phi > 0.5$	0										
Zone Size (mm)		Acceptable Qty																									
	A	B	C																								
$\Phi \leq 0.2$	Ignore																										
$0.3 < \Phi \leq 0.5$	2( distance $\geq 10\text{mm}$ )																										
$\Phi > 0.5$	0																										
Line defect (LCD/TP /Polarizer black/white line, scratch, stain)	<table border="1"> <thead> <tr> <th rowspan="2">Width(mm)</th> <th rowspan="2">Length(mm)</th> <th colspan="3">Acceptable Qty</th> </tr> <tr> <th>A</th> <th>B</th> <th>C</th> </tr> </thead> <tbody> <tr> <td><math>\Phi \leq 0.03</math></td> <td>Ignoe</td> <td colspan="2">Ignore</td> <td rowspan="3">Ignore</td> </tr> <tr> <td><math>0.03 &lt; W \leq 0.05</math></td> <td><math>L \leq 3.0</math></td> <td colspan="2"><math>N \leq 2</math></td> </tr> <tr> <td><math>0.05 &lt; W \leq 0.08</math></td> <td><math>L \leq 2.0</math></td> <td colspan="2"><math>N \leq 2</math></td> </tr> <tr> <td><math>0.08 &lt; W</math></td> <td colspan="4">Define as spot defect</td> </tr> </tbody> </table>	Width(mm)	Length(mm)	Acceptable Qty			A	B	C	$\Phi \leq 0.03$	Ignoe	Ignore		Ignore	$0.03 < W \leq 0.05$	$L \leq 3.0$	$N \leq 2$		$0.05 < W \leq 0.08$	$L \leq 2.0$	$N \leq 2$		$0.08 < W$	Define as spot defect			
Width(mm)	Length(mm)			Acceptable Qty																							
		A	B	C																							
$\Phi \leq 0.03$	Ignoe	Ignore		Ignore																							
$0.03 < W \leq 0.05$	$L \leq 3.0$	$N \leq 2$																									
$0.05 < W \leq 0.08$	$L \leq 2.0$	$N \leq 2$																									
$0.08 < W$	Define as spot defect																										

3.0	Polarizer Bubble	<table border="1"> <thead> <tr> <th rowspan="2">Zone Size (mm)</th> <th colspan="3">Acceptable Qty</th> </tr> <tr> <th>A</th> <th>B</th> <th>C</th> </tr> </thead> <tbody> <tr> <td><math>\Phi \leq 0.2</math></td> <td colspan="2">Ignore</td> <td rowspan="4">Ignore</td> </tr> <tr> <td><math>0.2 &lt; \Phi \leq 0.4</math></td> <td colspan="2">3(distance <math>\geq 10</math> m)</td> </tr> <tr> <td><math>0.4 &lt; \Phi \leq 0.6</math></td> <td colspan="2">2</td> </tr> <tr> <td><math>0.6 &lt; \Phi</math></td> <td colspan="2">0</td> </tr> </tbody> </table>			Zone Size (mm)	Acceptable Qty			A	B	C	$\Phi \leq 0.2$	Ignore		Ignore	$0.2 < \Phi \leq 0.4$	3(distance $\geq 10$ m)		$0.4 < \Phi \leq 0.6$	2		$0.6 < \Phi$	0	
		Zone Size (mm)	Acceptable Qty																					
			A	B	C																			
		$\Phi \leq 0.2$	Ignore		Ignore																			
		$0.2 < \Phi \leq 0.4$	3(distance $\geq 10$ m)																					
$0.4 < \Phi \leq 0.6$	2																							
$0.6 < \Phi$	0																							
4.0	SMT	According to IPC-A-610C class II standard . Function defect and missing part are major defect ,the others are minor defect.																						

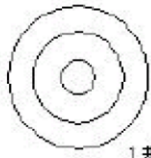
		TP bubble/ accidented spot	<table border="1"> <thead> <tr> <th rowspan="2">Size <math>\Phi</math>(mm)</th> <th colspan="3">Acceptable Qty</th> </tr> <tr> <th>A</th> <th>B</th> <th>C</th> </tr> </thead> <tbody> <tr> <td><math>\Phi \leq 0.1</math></td> <td colspan="2">Ignore</td> <td rowspan="4">Ignore</td> </tr> <tr> <td><math>0.1 &lt; \Phi \leq 0.25</math></td> <td colspan="2"></td> </tr> <tr> <td><math>0.25 &lt; \Phi \leq 0.3</math></td> <td colspan="2">2</td> </tr> <tr> <td><math>0.3 &lt; \Phi</math></td> <td colspan="2">0</td> </tr> </tbody> </table>			Size $\Phi$ (mm)	Acceptable Qty			A	B	C	$\Phi \leq 0.1$	Ignore		Ignore	$0.1 < \Phi \leq 0.25$			$0.25 < \Phi \leq 0.3$	2		$0.3 < \Phi$	0	
			Size $\Phi$ (mm)	Acceptable Qty																					
A	B	C																							
$\Phi \leq 0.1$	Ignore		Ignore																						
$0.1 < \Phi \leq 0.25$																									
$0.25 < \Phi \leq 0.3$	2																								
$0.3 < \Phi$	0																								
		Assembly deflection	beyond the edge of backlight $\leq 0.15$ mm																						

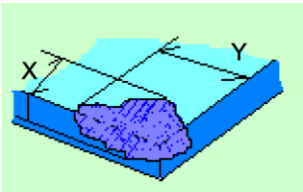
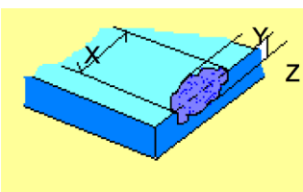
5.0	TP Related	Newton Ring	<p>Newton Ring area &gt; 1/3 TP area NG</p> <p>Newton Ring area ≤ 1/3 TP area OK</p>	 <p style="text-align: right;">1 规律性</p>  <p style="text-align: right;">2 非规律性</p>  <p style="text-align: center;">似牛顿环</p>						
		<p>TP corner broken</p> <p>X : length</p> <p>Y : width</p> <p>Z : height</p>	<table border="1" style="width: 100%; border-collapse: collapse; text-align: center;"> <tr> <td style="width: 33%;">X</td> <td style="width: 33%;">Y</td> <td style="width: 33%;">Z</td> </tr> <tr> <td>X ≤ 3.0mm</td> <td>Y ≤ 3.0mm</td> <td>Z &lt; LCD thickness</td> </tr> </table> <p>* Circuitry broken is not allowed.</p>	X	Y	Z	X ≤ 3.0mm	Y ≤ 3.0mm	Z < LCD thickness	
X	Y	Z								
X ≤ 3.0mm	Y ≤ 3.0mm	Z < LCD thickness								
		<p>TP edge broken</p> <p>X : length</p> <p>Y : width</p> <p>Z : height</p>	<table border="1" style="width: 100%; border-collapse: collapse; text-align: center;"> <tr> <td style="width: 33%;">X</td> <td style="width: 33%;">Y</td> <td style="width: 33%;">Z</td> </tr> <tr> <td>X ≤ 6.0mm</td> <td>Y ≤ 2.0mm</td> <td>Z &lt; LCD thickness</td> </tr> </table> <p>* Circuitry broken is not allowed.</p>	X	Y	Z	X ≤ 6.0mm	Y ≤ 2.0mm	Z < LCD thickness	
X	Y	Z								
X ≤ 6.0mm	Y ≤ 2.0mm	Z < LCD thickness								

Number	Items	Criteria (mm)
1	No display	Not allowed
2	Missing segment	Not allowed
3	Short	Not allowed
4	Backlight no lighting	Not allowed
5	TP no function	Not allowed



### 6.1.7 Classification of Defects

Visual defects (except no or wrong label) are treated as minor defects, while electrical defects are treated as major defects.

Two minor defects are equal to one major defect in lot sampling inspection.

### 6.1.8 Identification / marking criteria

Any unit with illegible / wrong / double or no marking / label shall be rejected.

## 6.2 DEALING WITH CUSTOMER COMPLAINTS

---

### 6.2.1 Non-conforming analysis

Purchaser should supply Densitron with detailed data of non-conforming sample.

After accepting it, Densitron should complete the analysis in two weeks from receiving the sample.

If the analysis cannot be completed on time, Densitron must inform the purchaser.

### 6.2.2 Handling of non-conforming displays

If any non-conforming displays are found during customer acceptance inspection which Densitron is clearly responsible for, return them to Densitron.

Both Densitron and customer should analyse the reason and discuss the handling of non-conforming displays when the reason is not clear.

Equally, both sides should discuss and come to agreement for issues pertaining to modification of Densitron quality assurance standard.

## 7 RELIABILITY SPECIFICATION

### 7.1 RELIABILITY TESTS

Test Item		Test Condition	
Durability Test	High Temperature Storage	Ta= 80°C	96h
	Low Temperature Storage	Ta=-30°C	96h
	Temperature Cycle Storage	-20°C $\leftrightarrow$ 70°C ON/OFF, 20 cycles. ON time over 10 seconds ,OFF time over 10 seconds	
	High Temperature Operation	Tp= 70°C	96h
	Low Temperature Operation	Tp= -20°C	96h
	High Temperature & Humidity Operation	Tp= 70°C RH= 90% 96h Non condensing	
	ESD Test	150Pf, 330Ω, ±6KV (Contact)/±8KV (Air), 5 Points/panel, 10 times/point	
	Thermal Shock Resistance	The sample should be allowed to stand the following 5 cycles of operation: TSTL for 30 minutes -> normal temperature for 5 minutes -> TSTH for 30 minutes -> normal temperature for 5 minutes, as one cycle, then taking it out and drying it at normal temperature, and allowing it stand for 24 hours	
	Box Drop Test	1 Corner 3 Edges 6 faces, 66 cm (Medium Box)	

Note: Ta=ambient temperature Tp= Panel temperature

Notes:

1. No dew condensation to be observed.
2. The function test shall be conducted after 4 hours storage at the normal temperature and humidity after removed from the test chamber.
3. No cosmetic or functional defects should be allowed.
4. Total current consumption should be less than twice the initial value.

## 8 HANDLING PRECAUTIONS

### **Safety**

If the LCD panel breaks, be careful not to get the liquid crystal fluid in your mouth or in your eyes. If the liquid crystal touches your skin or clothes, wash it off immediately using soap and plenty of water.

### **Mounting and Design**

Place a transparent plate (e.g. acrylic, polycarbonate or glass) on the display surface to protect the display from external pressure. Leave a small gap between the transparent plate and the display surface.

When assembling with a zebra connector, clean the surface of the pads with alcohol and keep the surrounding air very clean.

Design the system so that no input signal is given unless the power supply voltage is applied.

### **Caution during LCD cleaning**

Lightly wipe the display surface with a soft cloth soaked with Isopropyl alcohol, Ethyl alcohol or Trichlorotrifluoroethane.

Do not wipe the display surface with dry or hard materials that will damage the polariser surface.

Do not use aromatic solvents (toluene and xylene), or ketonic solvents (ketone and acetone).

### **Caution against static charge**

As the display uses C-MOS LSI drivers, connect any unused input terminal to VDD or VSS. Do not input any signals before power is turned on. Also, ground your body, work/assembly table and assembly equipment to protect against static electricity.

### **Packaging**

Displays use LCD elements, and must be treated as such. Avoid strong shock and drop from a height. To prevent displays from degradation, do not operate or store them exposed directly to sunshine or high temperature/humidity.

### **Caution during operation**

It is indispensable to drive the display within the specified voltage limit since excessive voltage shortens its life. Direct current causes an electrochemical reaction with remarkable deterioration of the display quality. Give careful consideration to prevent direct current during ON/OFF timing and during operation. Response time is extremely delayed at temperatures lower than the operating temperature range while, at high temperatures, displays become dark. However, this phenomenon is reversible and does not mean a malfunction or a display that has been permanently damaged. If the display area is pushed on hard during operation, some graphics will be abnormally displayed but returns to a normal condition after turning off the display once. Even a small amount of condensation on the contact pads (terminals) can cause an electro-chemical reaction which causes missing rows and columns. Give careful attention to avoid condensation.

### **Storage**

Store the display in a dark place where the temperature is  $25^{\circ}\text{C} \pm 10^{\circ}\text{C}$  and the humidity below 50%RH. Store the display in a clean environment, free from dust, organic solvents and corrosive gases.

Do not crash, shake or jolt the display (including accessories).

Product No.	DMT028QVNTNT0S-1A	REV. 1.1
-------------	-------------------	----------

Page	27 / 27
------	---------