



DMT10-2-1111

DMT

LONG RANGE DISTANCE SENSORS

SICK
Sensor Intelligence.



Ordering information

Model name	Part no.
DMT10-2-1111	1027603

Other models and accessories → www.sick.de/DMT



Detailed technical data

Performance

Measuring range	0,5 m ... 155 m, 90 % remission 0,5 m ... 65 m, 18 % remission 0,5 m ... 40 m, 6 % remission
Resolution	≤ 1 mm
Repeatability	7 mm ^{1) 2)} 10 mm ^{3) 2)}
Accuracy	± 10 mm ^{4) 5)}
Response time	1 ms ... 4.000 ms ⁶⁾
Cycle time	1,024 per sec.
Average depth	1/16/64/256/1,024
Output time	1 ms ... 4.000 ms ⁷⁾
Aperture delay time	≥ 1 s ⁷⁾
Light source	Laser, infrared
Laser class	1 (EN 60825-1:Nov.2001, IEC 60825-1:ÄM2:2001)
Typ. light spot size (distance)	20 mm (+ 5 x distance in m)
Note	Mechanical aperture
Special characteristic	Mechanical aperture

¹⁾ Dependant on distance and remission, 7 mm, at 6 % ... 90 % remission from 0.5 m ... 65 m, at 6 % ... 18 % remission from 0.5 m ... 40 m, at 6 % remission from 0.5 m ... 15 m.

²⁾ Environmental conditions constant, min. warm-up time 30 min, average depth 1,024, statistical error 1 σ .

³⁾ Dependant on distance and remission, 10 mm, at 6 % ... 90 % remission from 60 m ... 155 m, at 6 % ... 18 % remission from 40 m ... 65 m, at 6 % remission from 15 m ... 40 m.

⁴⁾ 23 °C air temperature, 977 hPa, min. warm-up time 30 min.

⁵⁾ When operating in ambient temperatures between +40 °C ... +55 °C the accuracy can decrease by factor 2.5.

⁶⁾ Dependant on average setting, average depth, timeout, baud rate, data output, output format and effective dead time of aperture.

⁷⁾ Dependant on average setting, average depth, timeout, baud rate, data output and output format.

Interfaces

Analog output	4 mA ... 20 mA, scalable
Switching output	Q ₁ , Q ₂ ¹⁾

¹⁾ Output Q short-circuit protected.

²⁾ Switchable.

Data interface	RS-422, RS-232 ²⁾
Interface for parametrization	RS-232

¹⁾ Output Q short-circuit protected.

²⁾ Switchable.

Mechanics/electronics

Supply voltage V_s	DC 18 V ... 30 V, limit values
Ripple	$< 5 V_{pp}$ ¹⁾
Power consumption	$\leq 6 W$ ²⁾
Initialization time	6 s
Connection type	1 x cable gland, 1 x Sub-D, 9-pin
Weight	Approx. 1.200 g
Output current I_A	100 mA

¹⁾ May not fall short of or exceed V_s tolerances.

²⁾ Without load.

Ambient data

Enclosure rating	IP 65
Protection class	III ¹⁾
Electromagnetic compatibility (EMC)	EN 55011:1998 Kl. B, Gr.1 EN 61000-6-2
Ambient temperature	Operation: $-10\text{ °C} \dots +55\text{ °C}$ Operation with cooling case: $-10\text{ °C} \dots +75\text{ °C}$ Storage: $-25\text{ °C} \dots +70\text{ °C}$
Temperature drift	Typ. 0,6 mm/K ²⁾ Typ. 0,3 mm/K ³⁾
Mechanical load	Shock: (IEC 60068-2-27, -2-29) Sine: (IEC 60068-2-6)

¹⁾ Reference voltage DC 50 V PELV-voltage (EN 50178)

²⁾ $-10\text{ °C} \dots 0\text{ °C}$, $+40\text{ °C} \dots +55\text{ °C}$.

³⁾ $0\text{ °C} \dots +40\text{ °C}$.

DMT10-2-1111 | DMT

LONG RANGE DISTANCE SENSORS

Dimensional drawing (Dimensions in mm (inch))

DMT10-2-x1xx DML40-2-x1xx

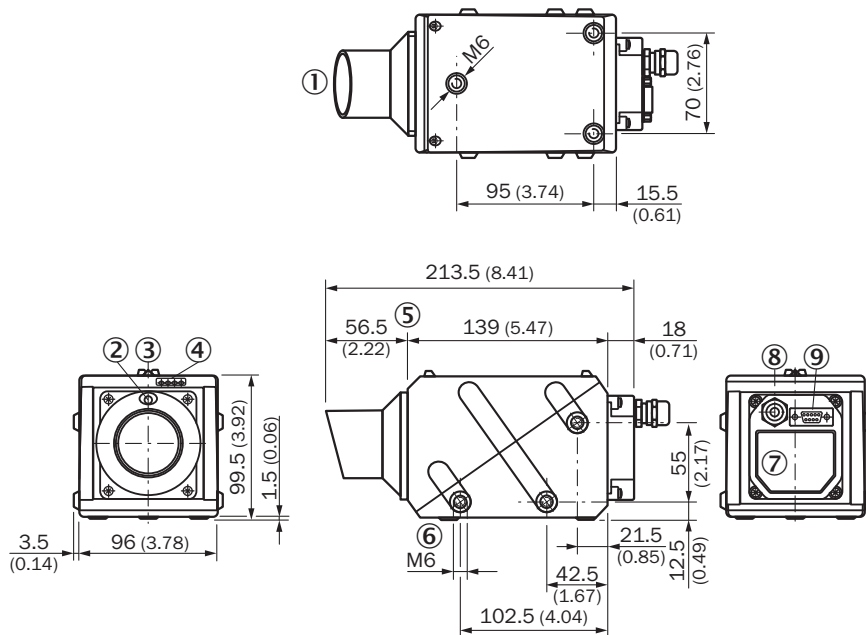

- ① Dust protection tube
- ② Laser pointer pilot light
- ③ Alignment sight
- ④ Function indicator
- ⑤ Zero level
- ⑥ Mounting hole M6 threaded - 6 mm deep
- ⑦ Connector cover
- ⑧ PG9
- ⑨ Sub-D, 9-pin

Connection type

DMxxx-2 RS-232/RS-422 Connector Sub-D, 9-pin

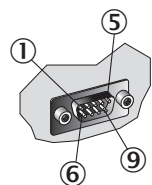

- ① Pin 1
- ⑤ Pin 5
- ⑥ Pin 6
- ⑨ Pin 9

DMxxx-2 RS-232/RS-422 PG9

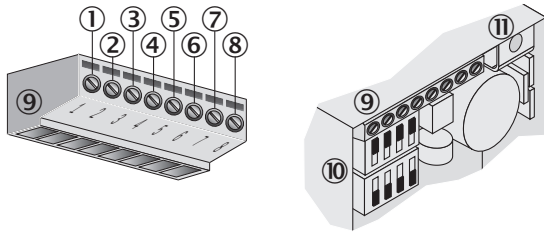

- ① Pin 1
- ② Pin 2
- ③ Pin 3
- ④ Pin 4
- ⑤ Pin 5
- ⑥ Pin 6
- ⑦ Pin 7
- ⑧ Pin 8
- ⑨ Terminals
- ⑩ DIP switches RS-232-/RS-422 switching
- ⑪ Shield

Connection diagram

DMxxx-2 RS-232/RS-422 PG9

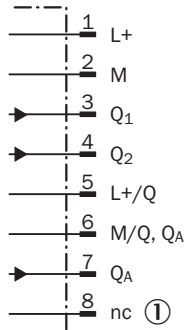

⑩ Not connected

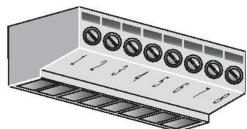
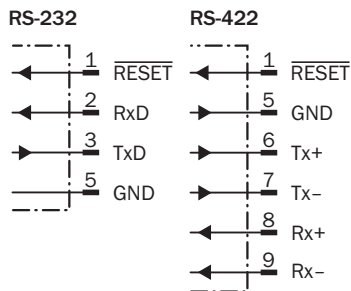

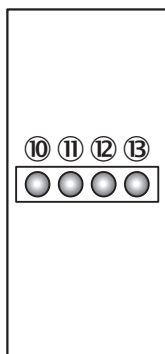

Adjustment possible



- ⑩ Q2 function indicator
- ⑪ Q1 function indicator
- ⑫ Operating indicator, green
- ⑬ Plausibility (measurement error) red

Recommended accessories

Other models and accessories → www.sick.de/DMT

	Brief description	Model name	Part no.
Terminal and alignment brackets			
	Alignment unit for DMT/DML, incl. mounting material, steel, zinc coated, mounting hardware included	BEF-GH-DMT	5309130
Plug connectors and cables			
	Head A: female connector, D-Sub, 9-pin, straight Head B: Cable Cable: serial, unshielded, 3 m	Connecting cable (female connector-open)	2020319

Australia

Phone +61 3 9457 0600
1800 33 48 02 - tollfree
E-Mail sales@sick.com.au

Belgium/Luxembourg

Phone +32 (0)2 466 55 66
E-Mail info@sick.be

Brasil

Phone +55 11 3215-4900
E-Mail marketing@sick.com.br

Canada

Phone +1 905 771 14 44
E-Mail information@sick.com

Česká republika

Phone +420 2 57 91 18 50
E-Mail sick@sick.cz

China

Phone +86 4000 121 000
E-Mail info.china@sick.net.cn
Phone +852-2153 6300
E-Mail ghk@sick.com.hk

Danmark

Phone +45 45 82 64 00
E-Mail sick@sick.dk

Deutschland

Phone +49 211 5301-301
E-Mail info@sick.de

España

Phone +34 93 480 31 00
E-Mail info@sick.es

France

Phone +33 1 64 62 35 00
E-Mail info@sick.fr

Great Britain

Phone +44 (0)1727 831121
E-Mail info@sick.co.uk

India

Phone +91-22-4033 8333
E-Mail info@sick-india.com

Israel

Phone +972-4-6801000
E-Mail info@sick-sensors.com

Italia

Phone +39 02 27 43 41
E-Mail info@sick.it

Japan

Phone +81 (0)3 5309 2112
E-Mail support@sick.jp

Magyarország

Phone +36 1 371 2680
E-Mail office@sick.hu

Nederland

Phone +31 (0)30 229 25 44
E-Mail info@sick.nl

Norge

Phone +47 67 81 50 00
E-Mail sick@sick.no

Österreich

Phone +43 (0)22 36 62 28 8-0
E-Mail office@sick.at

Polska

Phone +48 22 837 40 50
E-Mail info@sick.pl

România

Phone +40 356 171 120
E-Mail office@sick.ro

Russia

Phone +7-495-775-05-30
E-Mail info@sick.ru

Schweiz

Phone +41 41 619 29 39
E-Mail contact@sick.ch

Singapore

Phone +65 6744 3732
E-Mail sales.gsg@sick.com

Slovenija

Phone +386 (0)1-47 69 990
E-Mail office@sick.si

South Africa

Phone +27 11 472 3733
E-Mail info@sickautomation.co.za

South Korea

Phone +82 2 786 6321/4
E-Mail info@sickkorea.net

Suomi

Phone +358-9-25 15 800
E-Mail sick@sick.fi

Sverige

Phone +46 10 110 10 00
E-Mail info@sick.se

Taiwan

Phone +886-2-2375-6288
E-Mail sales@sick.com.tw

Türkiye

Phone +90 (216) 528 50 00
E-Mail info@sick.com.tr

United Arab Emirates

Phone +971 (0) 4 8865 878
E-Mail info@sick.ae

USA/México

Phone +1(952) 941-6780
1 800-325-7425 - tollfree
E-Mail info@sickusa.com

More representatives and agencies
at www.sick.com