



**FEATURES**

- 1500VDC Isolation
- Efficiency up to 86%
- Six-Sided Shielding
- MTBF>700,000 Hours
- Remote On/Off Control
- UL1950 Safety Approval
- Internal SMT Construction
- 4:1 Ultra Wide Input Range
- UL 94V-0 Package Material
- Complies with EN55022 Class A

**SPECIFICATIONS: DMW Ultra Wide Series**

All specifications are based on 25°C, Nominal Input Voltage, and Maximum Output Current unless otherwise noted.  
We reserve the right to change specifications based on technological advances.

SPECIFICATION	TEST CONDITIONS	Min	Nom	Max	Unit
<b>INPUT (V<sub>in</sub>)</b>					
Operating Voltage Range		9-36, 18-75			VDC
Start Voltage (24V input models)		8	8.5	9	VDC
Start Voltage (48V input models)		15	17	18	VDC
Under Voltage Shutdown (24V input models)		7	8	8.5	VDC
Under Voltage Shutdown (48V input models)		13	15	17	VDC
Reverse Polarity Input Current				1	A
Short Circuit Input Power			3500		mW
Input Surge Voltage (1000ms) (24V input models)		-0.7		50	VDC
Input Surge Voltage (1000ms) (48V input models)		-0.7		100	VDC
Input Filter		Pi Filter			
<b>OUTPUT (V<sub>o</sub>)</b>					
Output Voltage Range		See Rating Chart			
Output Voltage Accuracy			±1.0	±2.0	%
Output Voltage Balance	Dual Output, Balanced Loads		±0.5	±2.0	%
Load Regulation	I <sub>o</sub> = 10% to 100%		±0.5	±1.0	%
Line Regulation	V <sub>in</sub> = min. to max.		±0.1	±0.5	%
Output Power				15	W
Output Current Range		See Rating Chart			
Ripple & Noise (peak to peak)	20MHz		55	80	mV <sub>pk-pk</sub>
Ripple & Noise (peak to peak)	Over Line, Load, and Temperature			100	mV <sub>pk-pk</sub>
Ripple & Noise				15	mV <sub>rms</sub>
Transient Recovery Time	25% load step change		300	500	µs
Transient Response Deviation	25% load step change		±2	±4	%
<b>REMOTE ON/OFF</b>					
Supply On		2.5 to 5.5VDC or Open Circuit			
Supply Off		-0.7		0.8	VDC
Standby Input Current				10	mA
Control Input Current (On)	V <sub>in</sub> – RC = 5.0V			50	mA
Control Input Current (Off)	V <sub>in</sub> – RC = 0V			-1	mA
Control Common		Referenced to negative input			
<b>PROTECTION</b>					
Over Power Protection		120			%
Short Circuit Protection		Continuous			
Input Fuse Recommendation (24V input models)		2500mA Slow-Blow Type			
Input Fuse Recommendation (48V input models)		1250mA Slow-Blow Type			
<b>GENERAL</b>					
Efficiency		See Rating Chart			
Switching Frequency		290	330	400	KHz
Isolation Voltage Rated	60 seconds	1500			VDC
Isolation Voltage Test	Flash Test for 1 second	1650			VDC
Isolation Resistance	500VDC	1000			MΩ
Isolation Capacitance	100KHz, 1V		1200	1500	pF
Internal Power Dissipation				5,000	mW

SPECIFICATION	TEST CONDITIONS	Min	Nom	Max	Unit
<b>ENVIRONMENTAL</b>					
Operating Temperature (Ambient)		-40		+60	°C
Operating Temperature (Case)		-40		+100	°C
Storage Temperature		-50		+125	°C
Lead Temperature	1.5mm from case for 10 seconds			260	°C
Humidity				95	%
Cooling		Free air convection			
RFI		Six-sided shielding, metal case			
Temperature Coefficient			±0.01	±0.02	%/°C
MTBF	MIL-HDBK-217F @ 25°C, Ground Benign	700			Khours
Conducted EMI		EN55022 Class A			
<b>PHYSICAL</b>					
Weight		32 grams (heatsink 2g)			
Dimensions		2.0 x 1.0 x 0.4 inches			
Case Material		Metal with non-conductive baseplate			
Flammability		UL94V-0			
Heatsink material		Aluminum			
Heatsink finish		Anodic treatment (black)			

## OUTPUT VOLTAGE / CURRENT RATING CHART

Model Number	Input Voltage	Output Voltage	Output Current		Input Current		Reflected Ripple Current	Efficiency (Typ)	Max Capacitive Load			
			Min	Max	No Load	Max Load						
DMW24S3.3-3000	24 VDC (9 ~ 36 VDC)	3.3 VDC	300 mA	3000mA	25mA (typ)	528 mA	40mA (typ)	78%	470 µF			
DMW24S5-3000		5 VDC	300 mA	3000 mA						762 mA	82%	470 µF
DMW24S5.1-3000		5.1 VDC	300 mA	3000 mA						735 mA	81%	470 µF
DMW24S12-1250		12 VDC	125 mA	1250 mA						726 mA	85%	470 µF
DMW24S15-1000		15 VDC	100 mA	1000 mA						771 mA	86%	470 µF
DMW24D5-1500		±5 VDC	±150 mA	±1500 mA						735 mA	81%	220 µF
DMW24D12-625		±12 VDC	±62.5 mA	±625 mA						726 mA	85%	220 µF
DMW24D15-500		±15 VDC	±50 mA	±500 mA						787 mA	86%	220 µF
DMW48S3.3-3000		48 VDC (18 ~ 75 VDC)	3.3 VDC	300 mA						3000 mA	15mA (typ)	26 mA
DMW48S5-3000	5 VDC		300 mA	3000 mA	381 mA	82%	470 µF					
DMW48S5.1-3000	5.1 VDC		300 mA	3000 mA	368 mA	81%	470 µF					
DMW48S12-1250	12 VDC		125 mA	1250 mA	363 mA	85%	470 µF					
DMW48S15-1000	15 VDC		100 mA	1000 mA	386 mA	86%	470 µF					
DMW48D5-1500	±5 VDC		±150 mA	±1500 mA	368 mA	81%	220 µF					
DMW48D12-625	±12 VDC		±62.5 mA	±625 mA	363 mA	85%	220 µF					
DMW48D15-500	±15 VDC		±50 mA	±500 mA	393 mA	86%	220 µF					

## NOTES

- Specifications typical at +25°C, resistive load, nominal input voltage, rated output current unless otherwise noted.
- Transient recovery time is measured to within 1% error band for a step change in output load of 75% to 100%.
- Ripple and noise measured at 20MHz bandwidth.
- The DMW series requires a minimum 10% load on the output to maintain specified regulation. Operation under no-load condition will not damage these devices, however they may not meet all listed specifications.
- All DC/DC converters should be externally fused at the front end for protection.
- Other input and output voltages may be available, please contact factory.
- On/Off control is optional, please contact factory. Control voltage referenced to negative input (-Vin).
- Pin to pin tolerance ±0.01". Pin diameter tolerance ±0.002".
- MIL-HDBK-217F @ 25°C, ground benign.
- Heat-sink is optional, consult factory.

**MECHANICAL DRAWING**

**Standard**

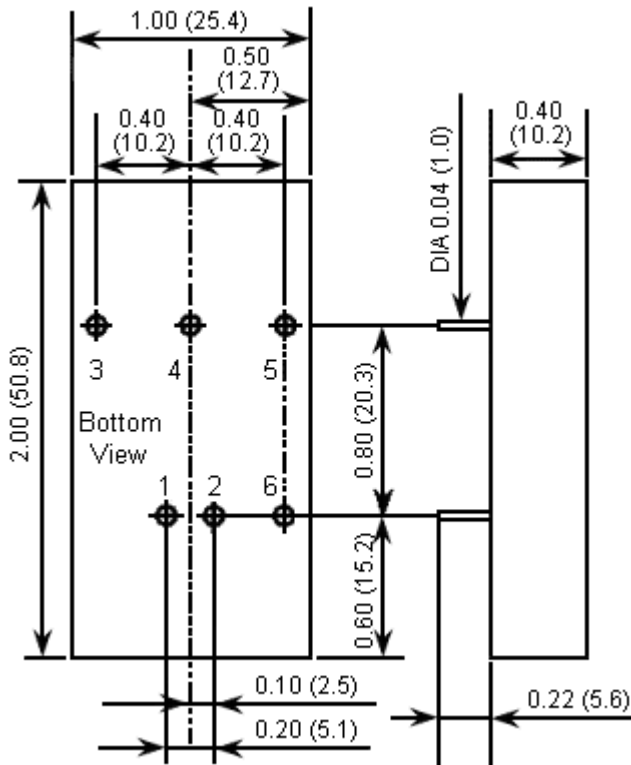

**With Heatsink**

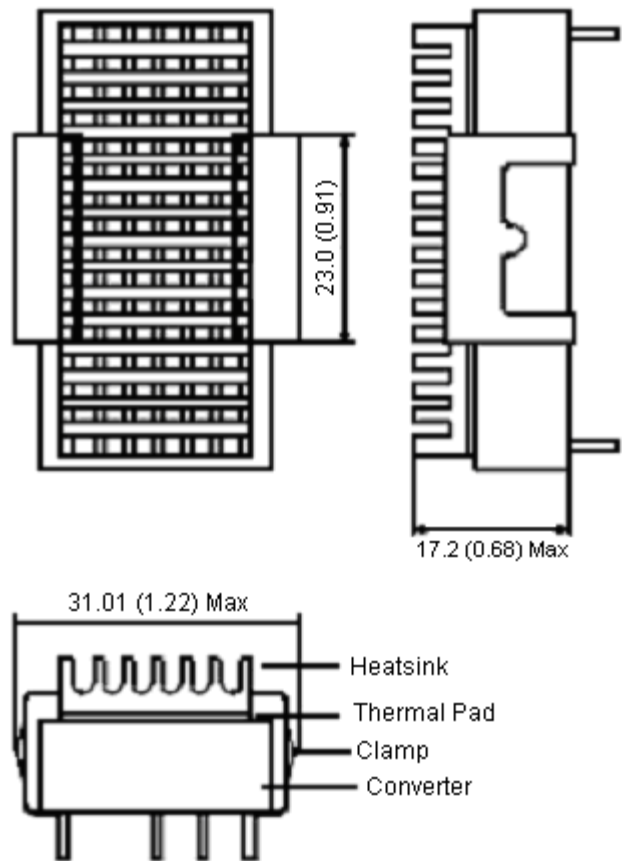

1. All dimensions in Inches (mm)  
Tolerance: X.X±0.0.1 (X.X±0.25)  
X.XX±0.005 (X.XX±0.13)  
2. Pin: ±0.002(±0.05)

PIN CONNECTIONS		
PIN	SINGLE OUTPUT	DUAL OUTPUT
1	+Vin	+Vin
2	-Vin	-Vin
3	+Vout	+Vout
4	No Pin	Common
5	-Vout	-Vout
6	Remote ON/OFF (Optional)	

**The Advantages of adding a Heatsink:**

1. To help heat dissipation and increase the stability and reliability of DC/DC converters at high operating temperature atmosphere.
2. To upgrade the operating temperature of DC/DC converters, please refer to the Derating Curve.

The DMW Series converter is encapsulated in a low thermal resistance molding compound that has excellent resistance/electrical characteristics over a wide temperature range or in high humidity environments.

The encapsulant and unit case are both rated to UL 94V-0 flammability specifications.

Leads are tin plated for improved solderability.

## DESIGN & FEATURE CONSIDERATIONS

### Remote On/Off

Positive logic remote on/off turns the module on during a logic high voltage on the remote on/off pin, and off during a logic low. To turn the power module on and off, the user must supply a switch to control the voltage between the on/off terminal and the -Vin terminal. The switch can be an open collector or equivalent.

A logic low is -0.7V to 0.8V.

A logic high is 2.5V to 5.5V.

The maximum sink current at on/off terminal during a logic low is -1mA. The maximum allowable leakage current of the switch at on/off terminal (2.5 to 5.5V) is 50uA.

### Over Current Protection

To provide protection in a fault (output overload) condition, the unit is equipped with internal current limiting circuitry and can endure current limiting for an unlimited duration. At the point of current-limit inception, the unit shifts from voltage control to current control. The unit operates normally once the output current is brought back into its specified range.

### Input Source Impedance

The power module should be connected to a low ac-impedance input source. Highly inductive source impedances can affect the stability of the power module. In applications where power is supplied over long lines and output loading is high, it may be necessary to use a capacitor at the input to ensure startup. Capacitor mounted close to the power module helps ensure stability of the unit, it is recommended to use a good quality low Equivalent Series Resistance (ESR < 1.0Ω at 100 KHz) capacitor of a 10uF for the 24V and 48V input devices.

www.DataSheet4U.com

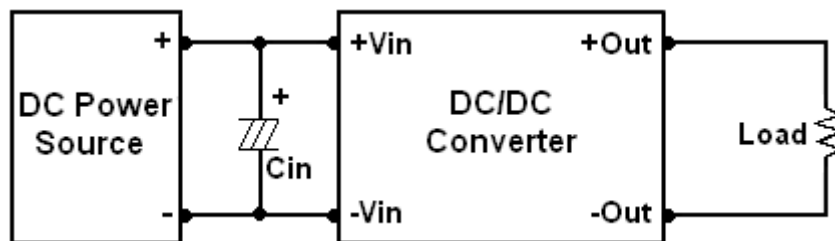

### Maximum Capacitive Load

The DMW Series has a limitation of maximum connected capacitance at the output. The power module may be operated in current limiting mode during start-up, affecting the ramp-up and the startup time. For optimum performance we recommend 220uF maximum capacitive load for dual outputs and 470uF capacitive load for single outputs. The maximum capacitance can be found in the Output Voltage / Current Rating Chart.

**Efficiency vs Input Voltage ( Single Output )**

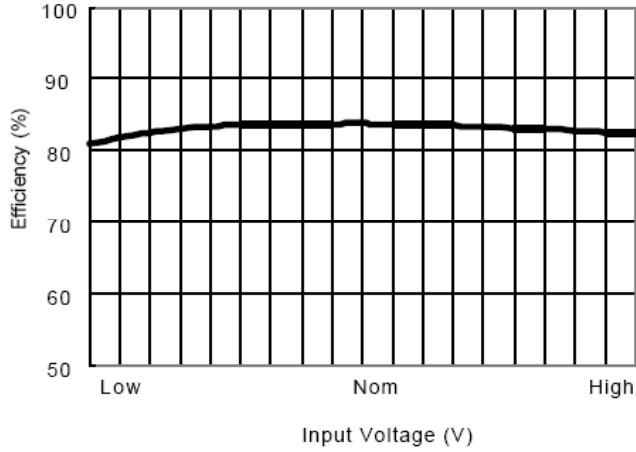

**Efficiency vs Input Voltage ( Dual Output )**

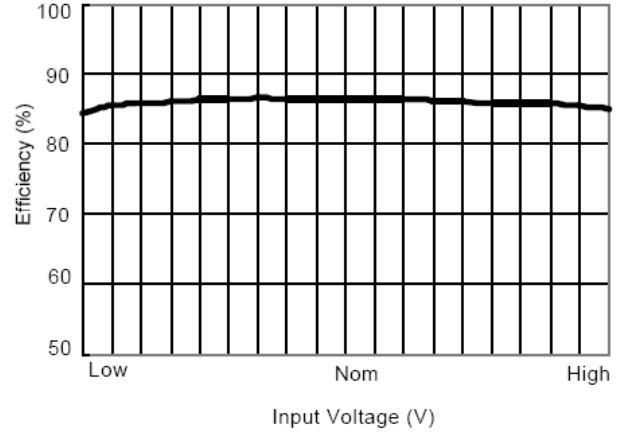

**Efficiency vs Output Load ( Single Output )**

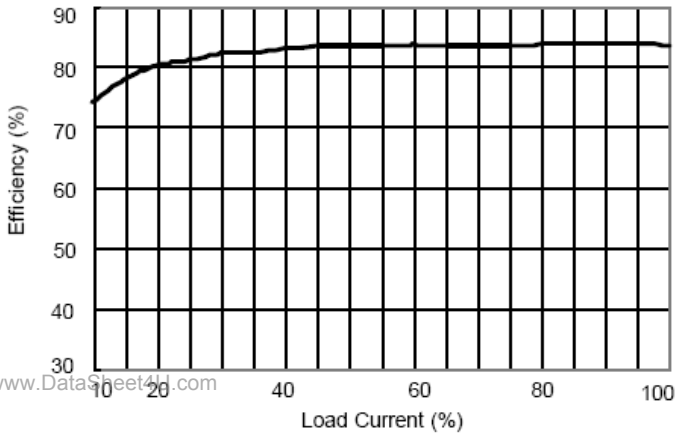

**Efficiency vs Output Load ( Dual Output )**

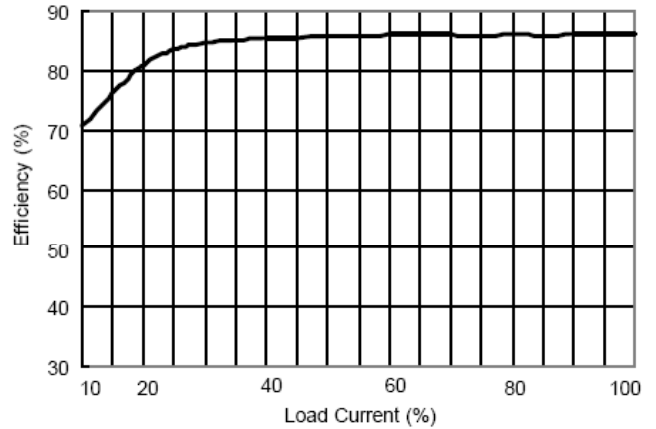

**Derating Curve without Heatsink**

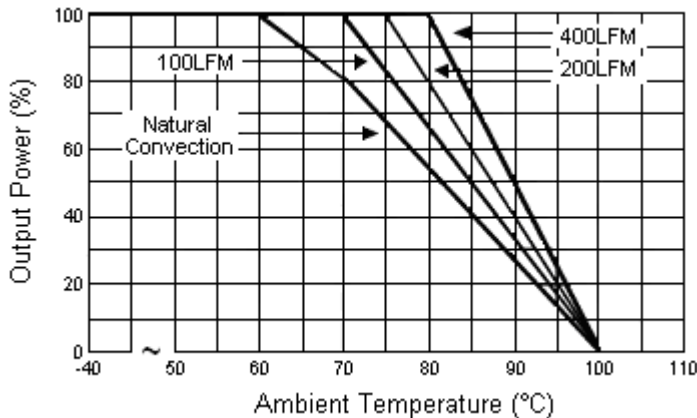

**Derating Curve with Heatsink**

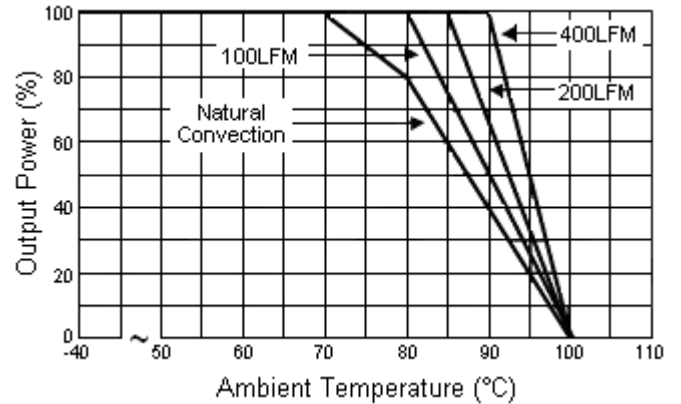

**BLOCK DIAGRAMS**

**Single Output**

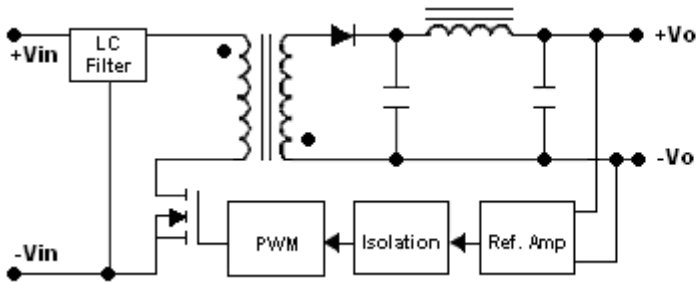

**Dual Output**

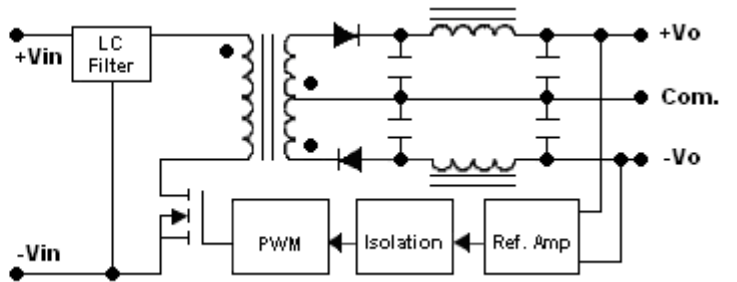

**Input Voltage Transient Rating**

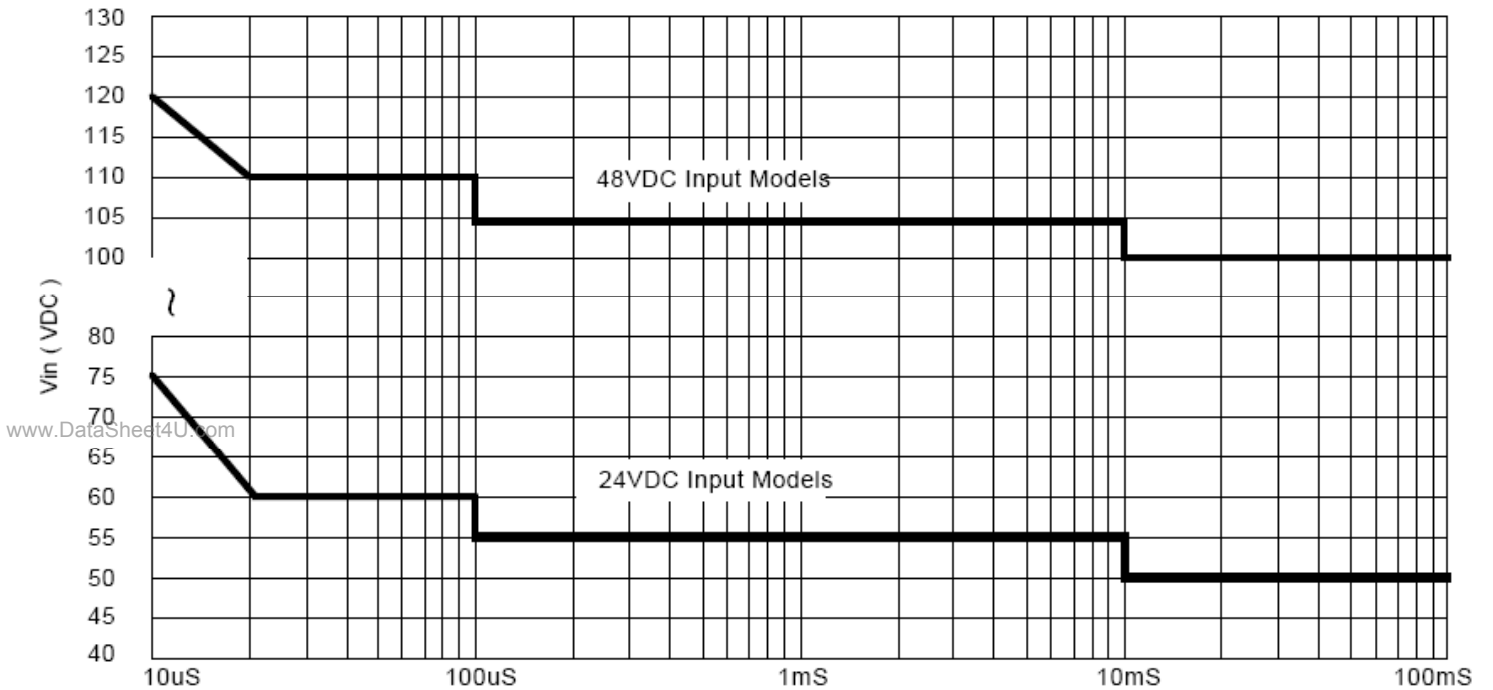

**TEST CONFIGURATIONS**

**Input Reflected-Ripple Current Test Setup**

Input reflected-ripple current is measured with an inductor  $L_{in}$  (4.7uH) and  $C_{in}$  (220uF, ESR < 1.0Ω at 100 KHz) to simulate source impedance.

Capacitor  $C_{in}$  offsets possible battery impedance.

Current ripple is measured at the input terminals of the module. Measurement bandwidth is 0-500 KHz.

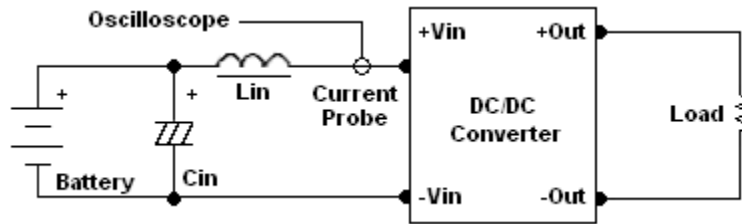

**Peak-to-Peak Output Noise Measurement Test**

Use a  $C_{out}$  0.47uF ceramic capacitor.

Scope measurement should be made by using a BNC socket; measurement bandwidth is 0-20 MHz. Position the load between 50 mm and 75 mm from the DC/DC Converter.

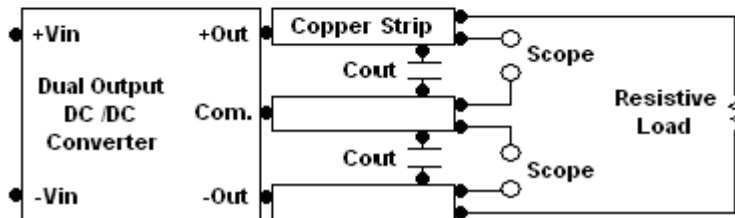
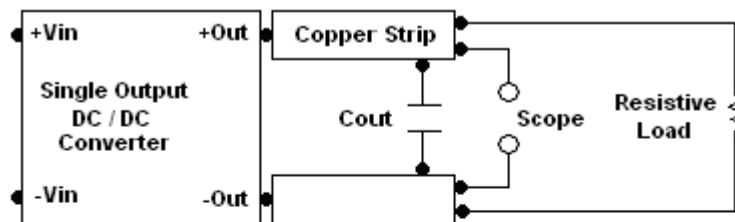

www.DataSheet4U.com

**Output Ripple Reduction**

A good quality low ESR capacitor placed as close as possible across the load will give the best ripple and noise performance. To reduce output ripple, it is recommended to use 4.7uF capacitors at the output.

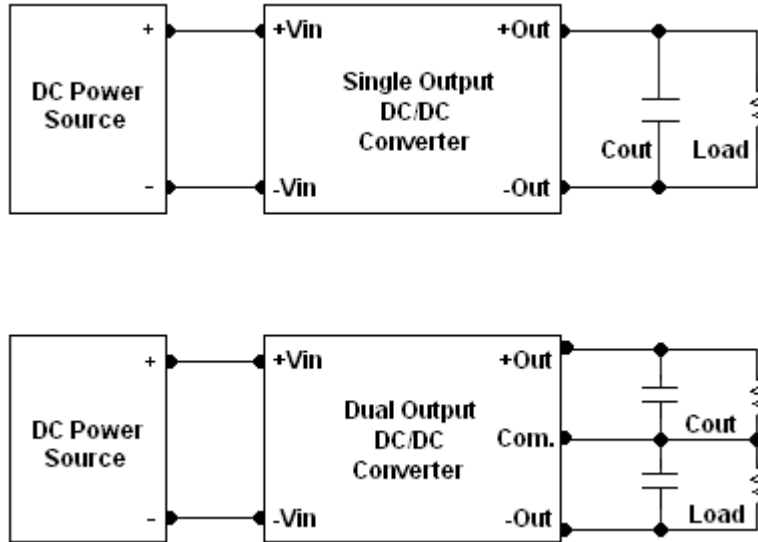

**Thermal Considerations**

Many conditions affect the thermal performance of the power module, such as orientation, airflow over the module, and board spacing. To avoid exceeding the maximum temperature rating of the components inside the power module, the case temperature must be kept below 100°C. The derating curves are determined from measurements obtained in an experimental apparatus.

[www.DataSheet4U.com](http://www.DataSheet4U.com)

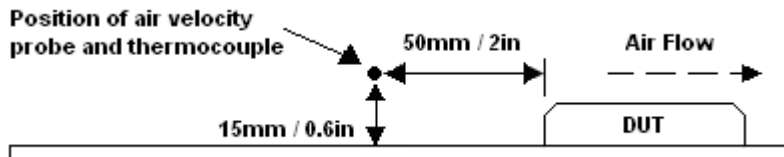



---

---

**COMPANY INFORMATION:**

Wall Industries, Inc. has created custom and modified units for over 40 years. Our in-house research and development engineers will provide a solution that exceeds your performance requirements on time and on budget. Our ISO9001-2000 certification is just one example of our commitment to producing a high quality, well documented product for our customers.

Our past projects demonstrate our commitment to you, our customer. Wall Industries, Inc. has a reputation for working closely with its customers to ensure each solution meets or exceeds form, fit and function requirements. We will continue to provide ongoing support for your project above and beyond the design and production phases. Give us a call today to discuss your future projects.

Contact **Wall Industries** for further information:

<u>Phone:</u>	☎ (603)778-2300
<u>Toll Free:</u>	☎ (888)587-9255
<u>Fax:</u>	☎ (603)778-9797
<u>E-mail:</u>	<a href="mailto:sales@wallindustries.com">sales@wallindustries.com</a>
<u>Web:</u>	<a href="http://www.wallindustries.com">www.wallindustries.com</a>
<u>Address:</u>	5 Watson Brook Rd. Exeter, NH 03833