

## Description

The DPS1133 is part of a family of power switches optimized for the USB Power Delivery and other hot-swap applications. Through the analog interface, exception status is reported and several functions can be programmed: current limit, overvoltage protection, and output voltage ramping up. The fast role swap function, which complies with the requirements defined in the USB Power Delivery Specification Release 3.0, V1.0a is implemented.

This device is designed to operate between 4.5V and 24V. It offers fast short-circuit response time to ensure system robustness. The integrated port-discharge function allows the voltage levels at the input and output ports to be discharged to meet the requirements of the USB Power Delivery Specification. Comprehensive fault detection and recovery mechanisms are provisioned to enable applications which are subjected to heavy capacitive loads and the risk of short circuit. These mechanisms include: reverse voltage and current blocking, input overvoltage protection, output overcurrent, short-circuit protection, and overtemperature shut-down. In addition, the rise time of output voltage can be adjusted to minimize in-rush current and to ensure system stability. Before any exception condition is notified via the low-active FAULTB signal, deglitch of 7ms is applied to prevent false triggering.

The DPS1133 is housed in the low-profile and space-saving V-QFN4040-17 package which is manufactured with environmental-friendly material.

## Features

- Wide Operating Voltage Range: 4.5V to 24V
- 1-Channel Power Switch With Integrated Adjustable Current & Voltage Limits
- Ability to Discharge the Input and Output Ports either Individually or Simultaneously via Two External Control Pins
- Fast Short-Circuit Response Time at 2 $\mu$ s
- Comprehensive Built-in Fault Detection and Recovery Mechanisms like Input Undervoltage Lock-out, Reverse Voltage & Current Blocking, Thermal Shutdown, Overcurrent and Short-Circuit Protection
- R<sub>DS(ON)</sub> of Embedded MOSFET at 30m $\Omega$
- Adjustable DV/DT Control at Start-up
- Fault Reporting (FAULTB) with Blanking Time at 7ms Typical
- Fast Role Swap Supported
- UL Recognized, File No. E322375
- IEC60950-1 CB Scheme Certified
- **Totally Lead-Free & Fully RoHS Compliant (Notes 1 & 2)**
- **Halogen and Antimony Free. "Green" Device (Note 3)**

Notes: 1. No purposely added lead. Fully EU Directive 2002/95/EC (RoHS), 2011/65/EU (RoHS 2) & 2015/863/EU (RoHS 3) compliant.  
 2. See <https://www.diodes.com/quality/lead-free/> for more information about Diodes Incorporated's definitions of Halogen- and Antimony-free, "Green" and Lead-free.  
 3. Halogen- and Antimony-free "Green" products are defined as those which contain <900ppm bromine, <900ppm chlorine (<1500ppm total Br + Cl) and <1000ppm antimony compounds.

## Pin Assignments

(Top View)

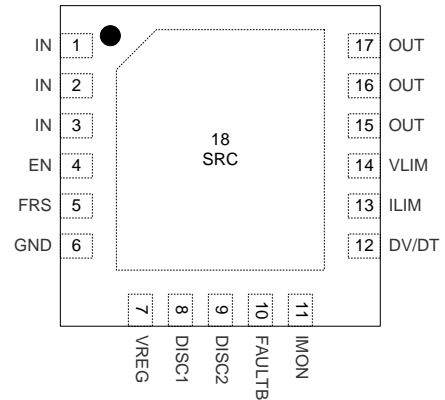

V-QFN4040-17

## Applications

- Notebook, Desktop, and AIO PCs, Servers, and Tablets
- Docking Stations, Universal and Multimedia Hubs
- FPTVs, PC Monitors
- Set-Top-Boxes, Residential Gateways, Storage Devices
- Power Protection in Industrial and Automotive Applications

## Typical Application Circuit

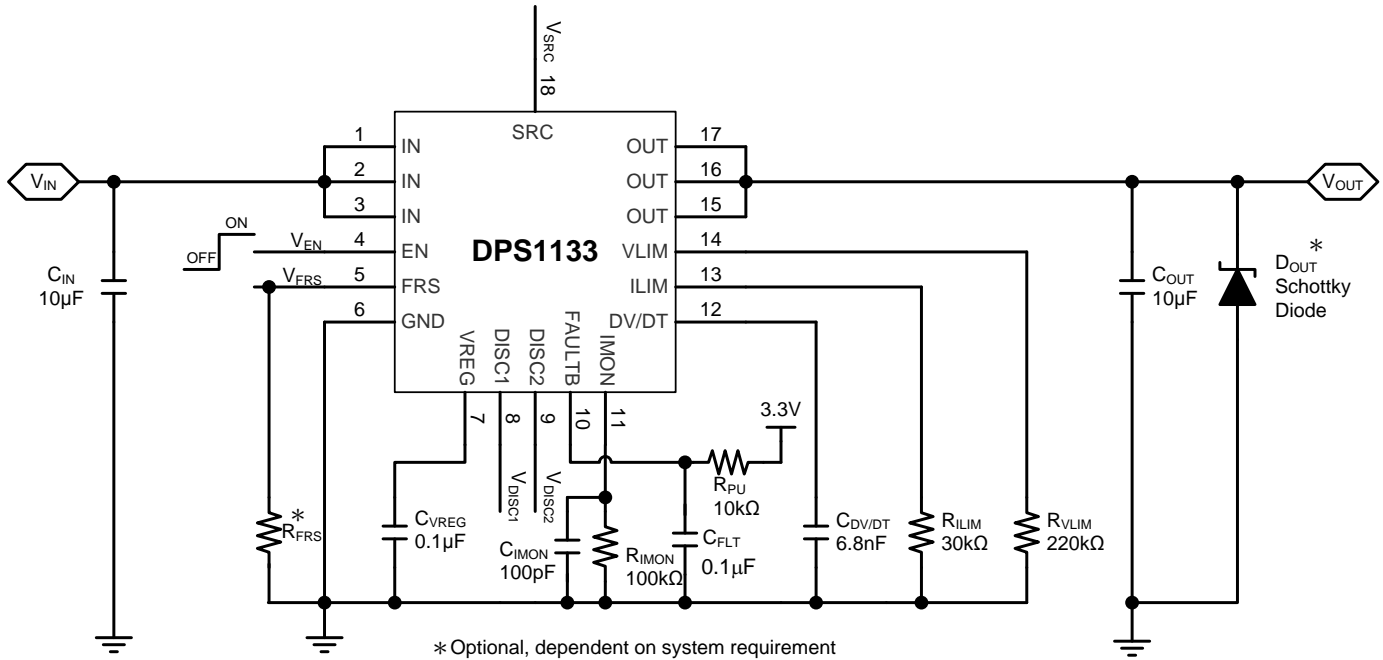

## Pin Descriptions

Pin Number	Pin Name	Type	Function
1, 2, 3	IN	P	Power Supply and Input port.
4	EN	I	Enable Input. Active high. '0' = Device OFF; '1' = Device ON. This pin must not be left floating.
5	FRS	I	Fast Role Swap Control. This pin enables the Fast Role Swap sequence defined in the USB Power Delivery Specification Release 3.0, V1.0a.
6	GND	GND	Device Ground.
7	VREG	I/O	Voltage Regulator. A 0.1µF is recommended between this pin and GND.
8	DISC1	I	IN Port Discharge Control. '1' = port voltage to be discharged; '0' = disabled.
9	DISC2	I	OUT Port Discharge Control. '1' = port voltage to be discharged; '0' = disabled.
10	FAULTB	O	Fault Status Indicator. An external pull-up resistor is required. This active-low pin is tied to GND when not used.
11	IMON	O	Current Monitor. A 100pF capacitor and a resistor connected in parallel between this pin and GND creates a positive average voltage proportional to the current flowing through the device. This pin can be left floating if current monitoring is not needed.
12	DV/DT	I/O	Ramp-up Control. A capacitor between this pin and GND sets the ramp-up rate.
13	ILIM	I/O	Current Limit Setting. A resistor between this pin and GND sets the overcurrent limit of the OUT port.
14	VLIM	I/O	Voltage Limit Setting. A resistor between this pin and GND sets the over-voltage limit of the IN port.
15, 16, 17	OUT	O	Output Port.
18 (Exposed Pad)	SRC	I/O	Common Source. The exposed pad of the V-QFN4040-17 package must not be connected to any signal.

## Functional Block Diagram

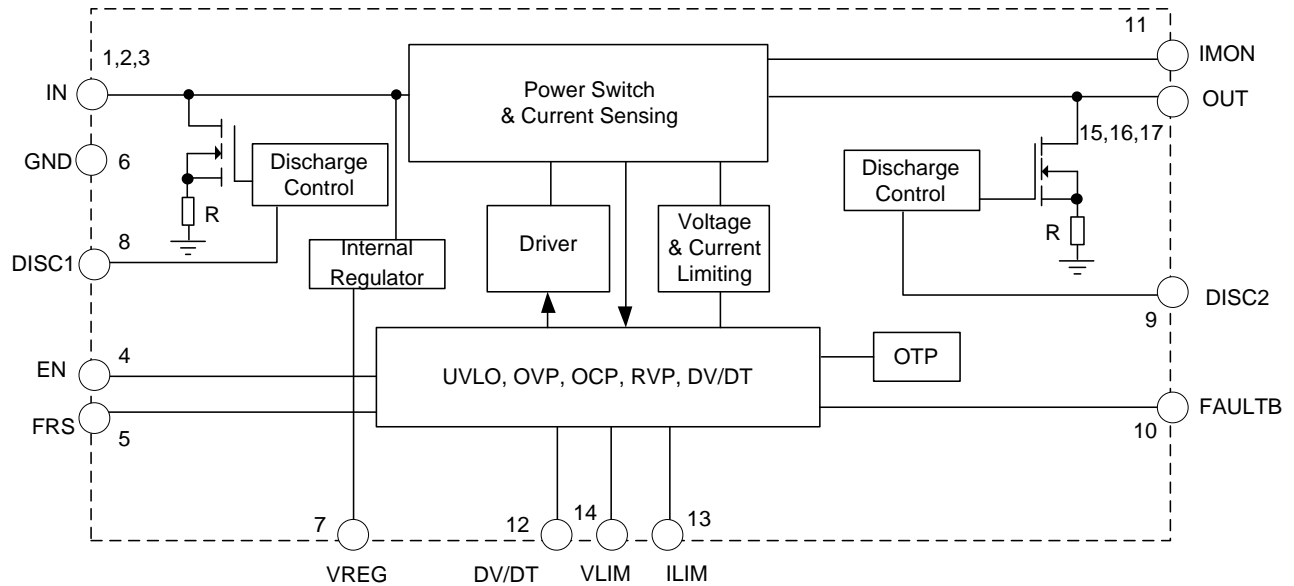

## Absolute Maximum Ratings (@ $T_A = +25^\circ\text{C}$ , unless otherwise specified) (Note 4)

Symbol	Parameter	Rating	Unit
$V_{IN}, V_{OUT}$	Voltage Range of Power IN and OUT Pins	-0.3 to 30	V
$V_{EN}$	Voltage Range of EN Pin	-0.3 to 30	V
$V_{I/O}$	Voltage Range of Other Pins (FRS, VREG, DISC1, DISC2, FAULTB, IMON, DV/DT, ILIM, VLIM)	-0.3 to 6	V
$I_{OUT}$	Load Current Range	5	A
$T_J$	Operating Junction Temperature	-40 to +125	$^\circ\text{C}$
$I_{OUTPULSE}$	Load Current Range ( $R_{LIM}=6.8\text{k}\Omega$ , 1s Pulse, Duty Cycle=1%)	14	A
$T_L$	Lead Temperature	+260	$^\circ\text{C}$
$T_{ST}$	Storage Temperature	-65 to +150	$^\circ\text{C}$
ESD	Human Body Model (HBM), JESD22-A114	2	kV
	Charge Device Model (CDM)	1	

## Thermal Characteristics (@ $T_A = +25^\circ\text{C}$ , unless otherwise specified) (Note 5)

Symbol	Parameter	Rating	Unit
$P_D$	Power Dissipation	1.7	W
$R_{\theta JA}$	Thermal Resistance, Junction-to-Ambient	58.5	$^\circ\text{C}/\text{W}$
$R_{\theta JC}$	Thermal Resistance, Junction-to-Case	12.3	$^\circ\text{C}/\text{W}$

Notes:

- These are stress ratings only. Operation outside the absolute maximum ratings can cause device failure. Operation at the absolute maximum rating for extended periods can reduce device reliability.
- Device mounted on FR-4 substrate PC board, 2oz copper, with 1" x 1" copper pad layout.

**Recommended Operating Conditions** (@  $T_A = +25^\circ\text{C}$ , unless otherwise specified.)

Symbol	Parameter	Min	Max	Unit
$V_{IN}$	Input Supply Voltage	4.5	24	V
$V_{OUT}$	Output Voltage	0	24	V
$I_{OUT}$	Output Load Current	0	3.5	A
$C_{IN}$	Input Capacitance	10	—	$\mu\text{F}$
$C_{OUT}$	Output Capacitance	1	100	$\mu\text{F}$
$V_{EN}$	Input Voltage on EN Pin	0	28	V
$V_{FRS}, V_{DISC1}, V_{DISC2}$	Input Voltage on FRS, DISC1, DISC2 Pins	0	5.5	V
$R_{VLIM}$	VLIM Resistance	51	270	k $\Omega$
$R_{ILIM}$	ILIM Resistance	27	200	k $\Omega$

**Electrical Characteristics** (@  $T_A = +25^\circ\text{C}$ ,  $V_{IN} = 4.5\text{V}$  to  $24\text{V}$ ,  $C_{IN} = C_{OUT} = 10\mu\text{F}$ ,  $V_{EN} = 3.3\text{V}$ ,  $V_{FRS} = 0\text{V}$ ,  $C_{D}/DT = 1\text{nF}$ ,  $R_{VLIM} = 240\text{k}\Omega$ ,  $R_{ILIM} = 27\text{k}\Omega$ , unless otherwise specified.)

Symbol	Parameter	Conditions	Min	Typ.	Max	Unit
<b>Bias Supply</b>						
$V_{REG}$	Regulated Voltage	$V_{IN} = 5\text{V}$	—	4.9	—	V
		$V_{IN} = 12\text{V}$	—	5.1	—	
		$V_{IN} = 24\text{V}$	—	5.2	—	
$V_{UVLO}$	$V_{IN}$ Undervoltage Lock-out Threshold	$V_{IN}$ Rising	3.2	3.6	4.0	V
$V_{UVHY}$	$V_{IN}$ Undervoltage Lock-out Threshold Hysteresis	$V_{IN}$ Falling	—	250	—	mV
$I_{SHDN}$	Shut-down Current (Disabled)	$V_{IN} = 5\text{V}, V_{EN} = 0\text{V}$	—	—	5	$\mu\text{A}$
		$V_{IN} = 12\text{V}, V_{EN} = 0\text{V}$	—	—	15	
		$V_{IN} = 24\text{V}, V_{EN} = 0\text{V}$	—	—	25	
$I_Q$	Quiescent Current (Enabled)	$V_{IN} = 5\text{V}, \text{No Load}$	—	1.5	1.9	mA
		$V_{IN} = 12\text{V}, \text{No Load}$	—	1.7	2.1	
		$V_{IN} = 24\text{V}, \text{No Load}$	—	2.2	2.6	
<b>MOSFET</b>						
$R_{DS(ON)}$	Switch ON Resistance	$V_{IN} = 5\text{V}$	—	29	36	m $\Omega$
		$V_{IN} = 12\text{V}$	—	29	36	
		$V_{IN} = 24\text{V}$	—	30	36	
$I_{LKGSRC}$	OUT Leakage Current in OFF State, Sourcing	$V_{EN} = 0\text{V}, V_{OUT} = 0\text{V}$	—	—	1	$\mu\text{A}$
$I_{LKGSNK}$	OUT Leakage Current in OFF State, Sinking	$V_{IN} = 3.3\text{V}, V_{EN} = 0\text{V}, V_{OUT} = 5\text{V}$	—	—	15	$\mu\text{A}$
		$V_{IN} = 3.3\text{V}, V_{EN} = 0\text{V}, V_{OUT} = 12\text{V}$	—	—	25	
		$V_{IN} = 3.3\text{V}, V_{EN} = 0\text{V}, V_{OUT} = 24\text{V}$	—	—	40	
<b>Enable Control</b>						
$V_{ENL}$	EN Threshold Voltage Low	$V_{EN}$ Falling	—	—	0.4	V
$V_{ENH}$	EN Threshold Voltage High	$V_{EN}$ Rising	1.4	—	—	
$I_{EN}$	EN Input Leakage Current	$V_{IN} = 5\text{V}, V_{EN} = 5\text{V}$	—	—	5	$\mu\text{A}$
<b>Output Ramping Control</b>						
$I_{DV/DT}$	DV/DT Sourcing Current	$V_{DV/DT} = 0\text{V}$	—	1	—	$\mu\text{A}$
$G_{DV/DT}$	DV/DT to OUT Gain	$\Delta V_{OUT} / \Delta V_{DV/DT}$ , Guaranteed by Design	—	12	—	V/V

**Electrical Characteristics** (Cont.) (@  $T_A = +25^\circ\text{C}$ ,  $V_{IN} = 4.5\text{V}$  to  $24\text{V}$ ,  $C_{IN} = C_{OUT} = 10\mu\text{F}$ ,  $V_{EN} = 3.3\text{V}$ ,  $V_{FRS} = 0\text{V}$ ,  $C_{DV/DT} = 1\text{nF}$ ,  $R_{VLIM} = 240\text{k}\Omega$ ,  $R_{ILIM} = 27\text{k}\Omega$ , unless otherwise specified.)

Symbol	Parameter	Conditions	Min	Typ.	Max	Unit
<b>Output Timing</b>						
$t_{DON}$	Output Turn-ON Delay Time	$V_{IN} = 5\text{V}$ , $C_{OUT} = 1\mu\text{F}$ , $V_{EN} = 0\text{V}$ to $3.3\text{V}$	—	0.2	—	ms
		$V_{IN} = 12\text{V}$ , $C_{OUT} = 1\mu\text{F}$ , $V_{EN} = 0\text{V}$ to $3.3\text{V}$	—	0.2	—	
		$V_{IN} = 24\text{V}$ , $C_{OUT} = 1\mu\text{F}$ , $V_{EN} = 0\text{V}$ to $3.3\text{V}$	—	0.2	—	
$t_R$	Output Turn-ON Rise Time	$V_{IN} = 5\text{V}$ , $C_{OUT} = 1\mu\text{F}$ , $V_{EN} = 0\text{V}$ to $3.3\text{V}$	—	0.3	—	ms
		$V_{IN} = 12\text{V}$ , $C_{OUT} = 1\mu\text{F}$ , $V_{EN} = 0\text{V}$ to $3.3\text{V}$	—	0.8	—	
		$V_{IN} = 24\text{V}$ , $C_{OUT} = 1\mu\text{F}$ , $V_{EN} = 0\text{V}$ to $3.3\text{V}$	—	1.6	—	
$t_{DOFF}$	Output Turn-OFF Delay Time	$V_{IN} = 5\text{V}$ , $C_{OUT} = 1\mu\text{F}$ , $V_{EN} = 3.3\text{V}$ to $0\text{V}$	—	1	—	$\mu\text{s}$
		$V_{IN} = 12\text{V}$ , $C_{OUT} = 1\mu\text{F}$ , $V_{EN} = 3.3\text{V}$ to $0\text{V}$	—	2	—	
		$V_{IN} = 24\text{V}$ , $C_{OUT} = 1\mu\text{F}$ , $V_{EN} = 3.3\text{V}$ to $0\text{V}$	—	4	—	
$t_F$	Output Turn-OFF Fall Time	$V_{IN} = 5\text{V}$ , $C_{OUT} = 1\mu\text{F}$ , $V_{EN} = 3.3\text{V}$ to $0\text{V}$	—	10	—	$\mu\text{s}$
		$V_{IN} = 12\text{V}$ , $C_{OUT} = 1\mu\text{F}$ , $V_{EN} = 3.3\text{V}$ to $0\text{V}$	—	25	—	
		$V_{IN} = 24\text{V}$ , $C_{OUT} = 1\mu\text{F}$ , $V_{EN} = 3.3\text{V}$ to $0\text{V}$	—	50	—	
<b>Fast Role Swap (FRS) Control and Timing</b>						
$V_{FRSL}$	FRS Threshold Voltage Low	$V_{FRS}$ Falling	—	—	0.4	V
$V_{FRSH}$	FRS Threshold Voltage High	$V_{FRS}$ Rising	1.4	—	—	
$I_{FRS}$	FRS Input Leakage Current	$V_{IN} = 5\text{V}$ , $V_{FRS} = 5\text{V}$	—	—	7	$\mu\text{A}$
$t_{FRS\_ON}$	FRS ON Time	$V_{IN} = 5\text{V}$ , A Single Positive Pulse Width on FRS and $V_{FRSH} = 3.3\text{V}$ , Guaranteed by Design	600	—	—	$\mu\text{s}$
$t_{DON\_FRS}$	Output Turn-ON Delay Time with FRS	$V_{IN} = 5\text{V}$ , $C_{OUT} = 1\mu\text{F}$ , $V_{FRS} = 3.3\text{V}$ to $0\text{V}$ , 50% Falling Edge of $V_{FRS}$ to 90% Rising Edge of $V_{OUT}$ , Guaranteed by Design	—	—	60	$\mu\text{s}$
<b>Discharge Control on IN and OUT Ports</b>						
$R_{DISC1} / R_{DISC2}$	IN / OUT Discharge Resistance	$V_{DISC1} = 5\text{V}$ , $V_{DISC2} = 5\text{V}$	—	105	—	$\Omega$
		$V_{DISC1} = 3.3\text{V}$ , $V_{DISC2} = 3.3\text{V}$	—	115	—	$\Omega$
$V_{DISC1L} / V_{DISC2L}$	DISC1 / DISC2 Threshold Voltage Low	$V_{DISC1} / V_{DISC2}$ Falling	—	—	0.4	V
$V_{DISC1H} / V_{DISC2H}$	DISC1 / DISC2 Threshold Voltage High	$V_{DISC1} / V_{DISC2}$ Rising	1.4	—	—	V
<b>Overcurrent Protection</b>						
$V_{ILIM}$	ILIM Bias Voltage	$R_{ILIM} = 50\text{k}\Omega$	—	1	—	V
$I_{LIM}$	Current Limit, 1A	$R_{ILIM} = 100\text{k}\Omega$	0.9	1.05	1.20	A
	Current Limit, 2A	$R_{ILIM} = 50\text{k}\Omega$	1.8	2	2.2	
	Current Limit, 3A	$R_{ILIM} = 33.3\text{k}\Omega$	2.76	3	3.24	
$I_{FASTRIP}$	Fast-Trip Threshold	Guaranteed by Design	—	$1.125 \times I_{LIM} + 1.8$	—	A
<b>Current Monitoring Output</b>						
$V_{IMON}$	Current Monitoring Output Voltage	—	—	—	4.5	V
$G_{IMON}$	IMON to OUT Current Gain	$I_{IMON} / I_{OUT}$	—	10	—	$\mu\text{A/A}$
<b>Overvoltage Protection</b>						
$I_{VLIM}$	VLIM Sourcing Current	$V_{IN} = 5\text{V}$ , $R_{VLIM} = 54.9\text{k}\Omega$	—	10	—	$\mu\text{A}$
$V_{OVPRTH}$	Input Overvoltage Threshold, Rising	$R_{VLIM} = 54.9\text{k}\Omega$ , $V_{IN}$ Rising	—	6	—	V
		$R_{VLIM} = 240\text{k}\Omega$ , $V_{IN}$ Rising	—	24.5	—	
$V_{OVPFTH}$	Input Overvoltage Threshold, Falling	$R_{VLIM} = 54.9\text{k}\Omega$ , $V_{IN}$ Falling	—	5.5	—	V
		$R_{VLIM} = 240\text{k}\Omega$ , $V_{IN}$ Falling	—	24	—	

**Electrical Characteristics** (Cont.) (@  $T_A = +25^\circ\text{C}$ ,  $V_{IN} = 4.5\text{V}$  to  $24\text{V}$ ,  $C_{IN} = C_{OUT} = 10\mu\text{F}$ ,  $V_{EN} = 3.3\text{V}$ ,  $V_{FRS} = 0\text{V}$ ,  $C_{DV/DT} = 1\text{nF}$ ,  $R_{VLIM} = 240\text{k}\Omega$ ,  $R_{ILIM} = 27\text{k}\Omega$ , unless otherwise specified.)

Symbol	Parameter	Conditions	Min	Typ.	Max	Unit
<b>Reverse-voltage Protection</b>						
$V_{RVPFTH}$	$V_{IN} - V_{OUT}$ Threshold Entering into Reverse Protection	$V_{IN} - V_{OUT}$ Falling	—	-30	—	mV
$V_{RVPRTH}$	$V_{IN} - V_{OUT}$ Threshold Exiting from Reverse Protection	$V_{IN} - V_{OUT}$ Rising	—	0	—	
$t_{RVPTD}$	Reverse Protection Response Time	—	—	2	—	$\mu\text{s}$
<b>Fault Flag (FAULTB): Active-Low</b>						
$R_{FAULTB}$	FAULTB Pull-down Resistor	$V_{IN} = 7\text{V}$ , $R_{VLIM} = 54.9\text{k}\Omega$ , $I_{FAULTB} = 10\text{mA}$ Sinking	—	25	—	$\Omega$
$I_{LKGFAULTB}$	FAULTB Leakage Current	$V_{IN} = 5\text{V}$ , $R_{VLIM} = 54.9\text{k}\Omega$ , $V_{FAULTB} = 5\text{V}$	—	—	1	$\mu\text{A}$
$t_{BLANKFAULTB}$	FAULTB Blanking Time	$V_{IN} = 5\text{V}$ , $R_{VLIM} = 54.9\text{k}\Omega$ , $V_{FAULTB} = 5\text{V}$	—	7	—	ms
<b>Thermal Shut-Down</b>						
$T_{SHDN}$	Thermal Shut-down Threshold	—	—	+155	—	$^\circ\text{C}$
$T_{HYS}$	Thermal Shut-down Hysteresis	—	—	+20	—	

**Performance Characteristics** (@  $T_A = +25^\circ\text{C}$ ,  $C_{IN} = C_{OUT} = 10\mu\text{F}$ ,  $V_{EN} = 3.3\text{V}$ ,  $V_{FRS} = 0\text{V}$ ,  $C_{DV/DT} = 1\text{nF}$ ,  $R_{LIM} = 27\text{k}\Omega$ , unless otherwise specified.)

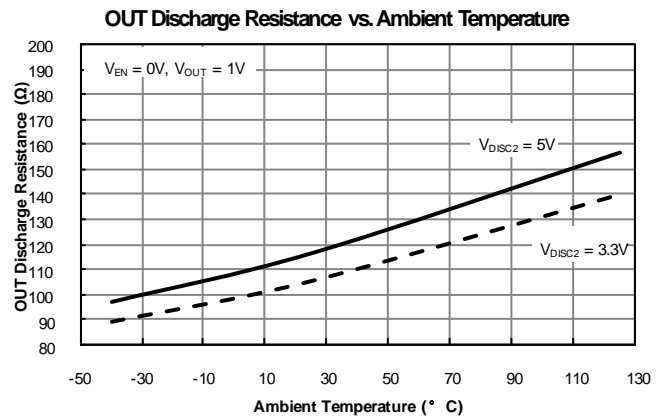
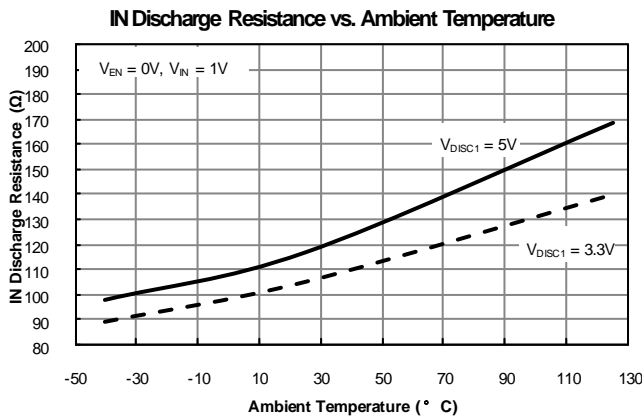
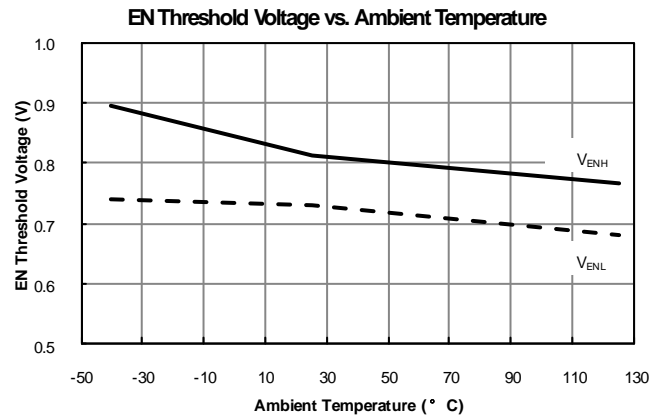
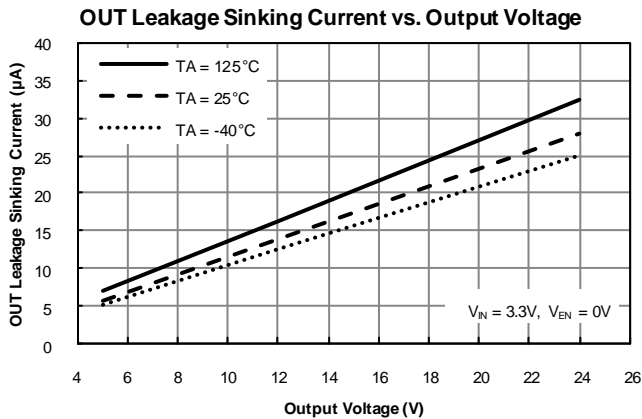
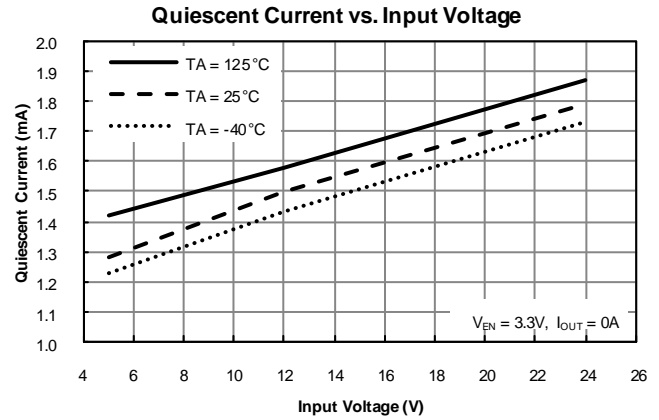
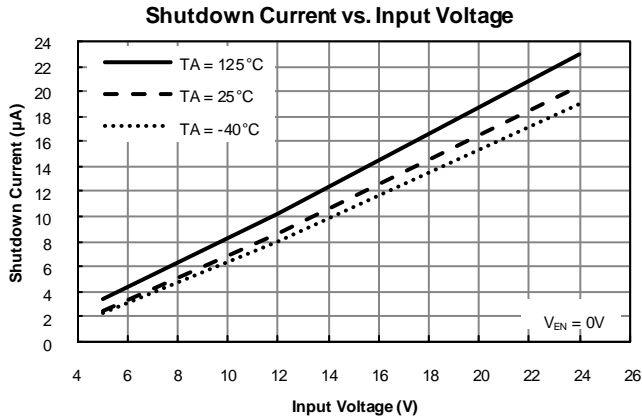

**Performance Characteristics** (Cont.) (@  $T_A = +25^\circ\text{C}$ ,  $C_{IN} = C_{OUT} = 10\mu\text{F}$ ,  $V_{EN} = 3.3\text{V}$ ,  $V_{FRS} = 0\text{V}$ ,  $C_{DV/DT} = 1\text{nF}$ ,  $R_{LIM} = 27\text{k}\Omega$ , unless otherwise specified.)

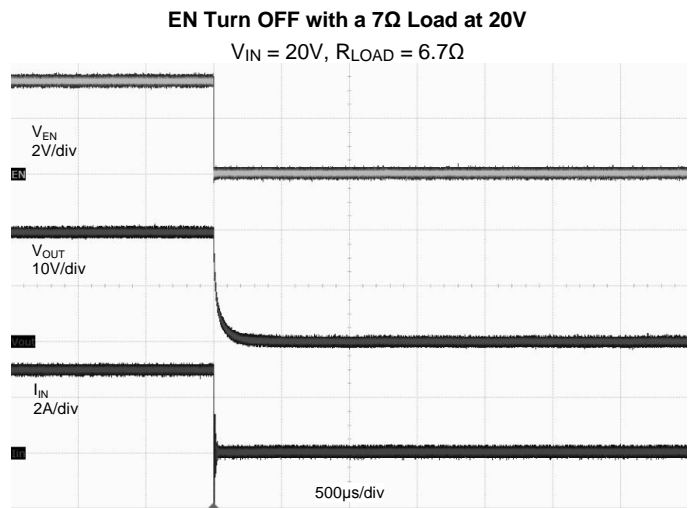
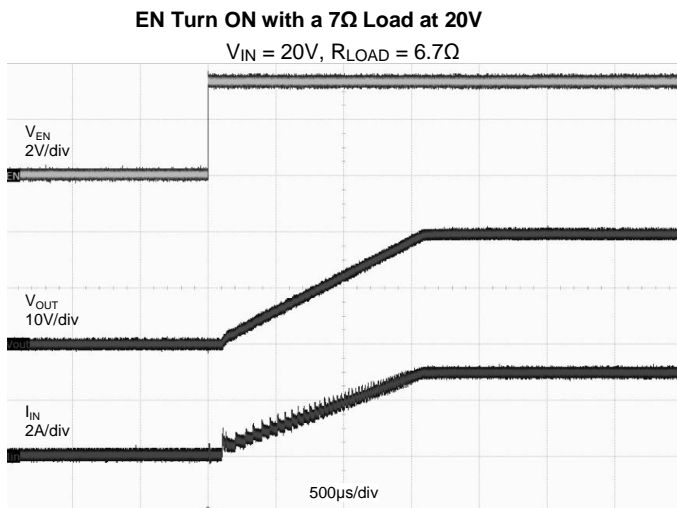
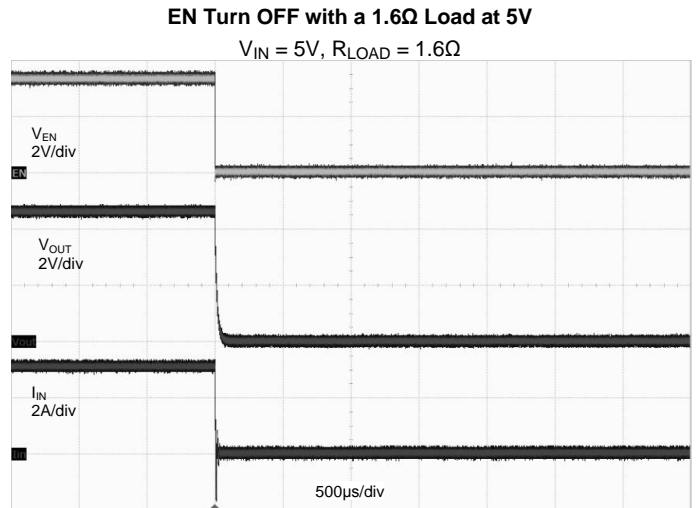
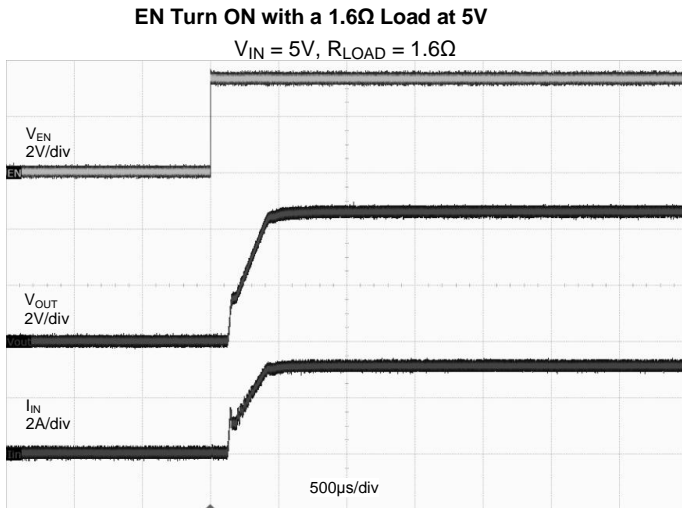
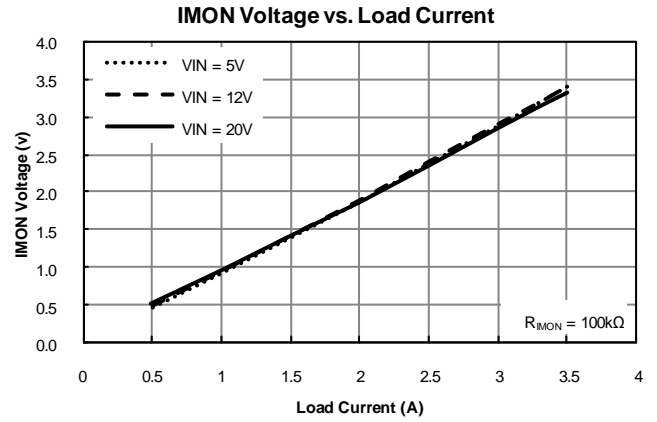
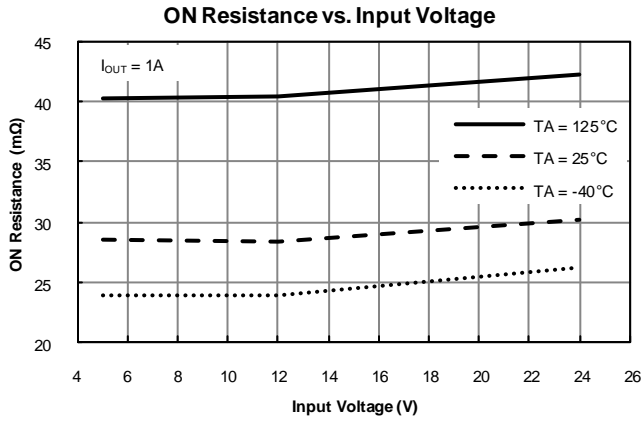



**Performance Characteristics** (Cont.) (@  $T_A = +25^\circ\text{C}$ ,  $C_{IN} = C_{OUT} = 10\mu\text{F}$ ,  $V_{EN} = 3.3\text{V}$ ,  $V_{FRS} = 0\text{V}$ ,  $C_{DV/DT} = 1\text{nF}$ ,  $R_{LIM} = 27\text{k}\Omega$ , unless otherwise specified.)

**OUT Always Short to Ground at 5V**  
 $V_{IN} = 5\text{V}$ , OUT Port Short to Ground

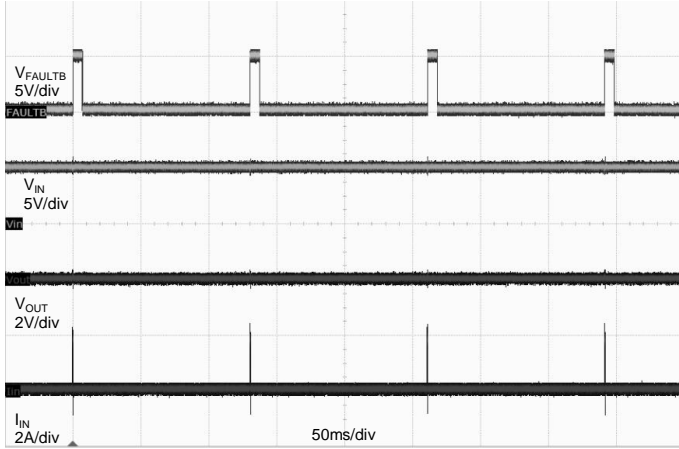

**OUT Always Short to Ground at 20V**  
 $V_{IN} = 20\text{V}$ , OUT Port Short to Ground

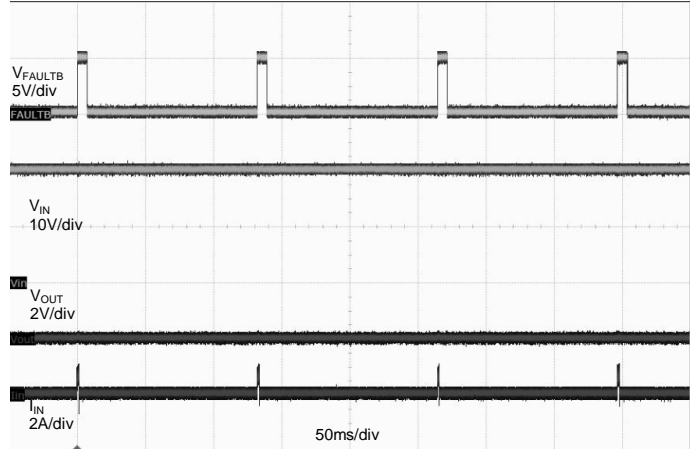

**Overcurrent Protection at 5V**  
 $V_{IN} = 5\text{V}$ ,  $R_{LOAD} = 100\Omega$  to  $1.2\Omega$

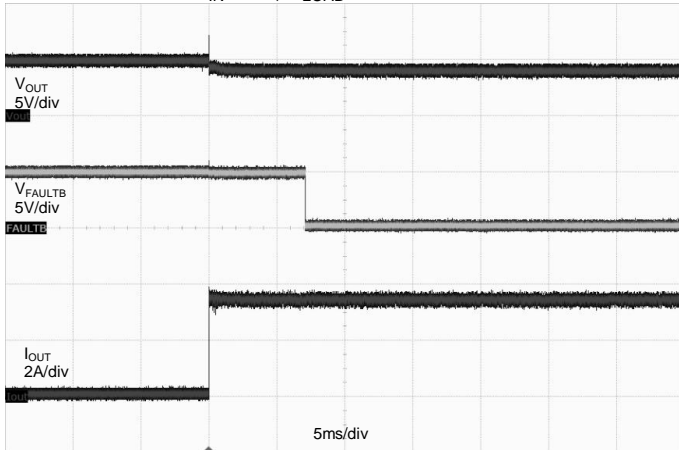

**Overcurrent Recovery at 5V**  
 $V_{IN} = 5\text{V}$ ,  $R_{LOAD} = 1.2\Omega$  to  $100\Omega$

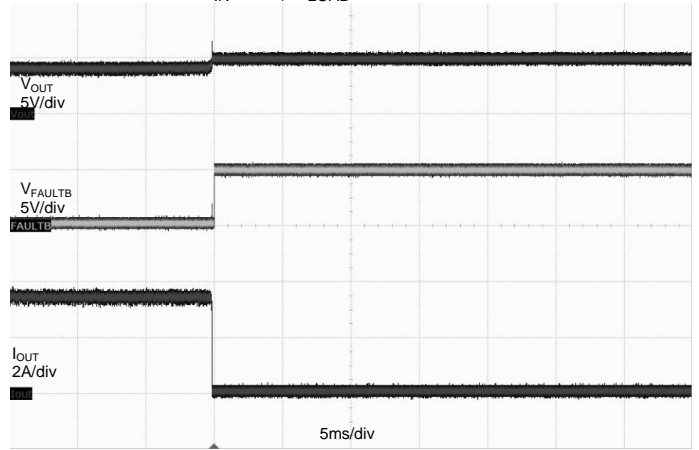

**Input Overvoltage Protection and Recovery**  
 $V_{IN} = 5\text{V}$  to  $7\text{V}$  then back to  $5\text{V}$ ,  $R_{VLIM} = 56\text{k}\Omega$ ,  $R_{LOAD} = 1\text{k}\Omega$

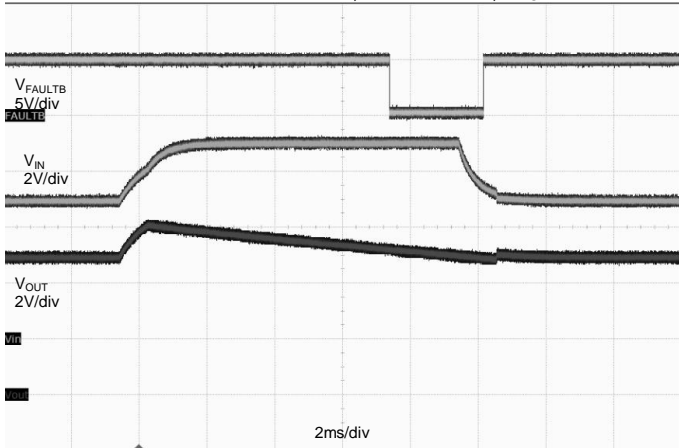

**Reverse-voltage Response**  
 $V_{IN} = 5\text{V}$ , Supply 24V to OUT Port

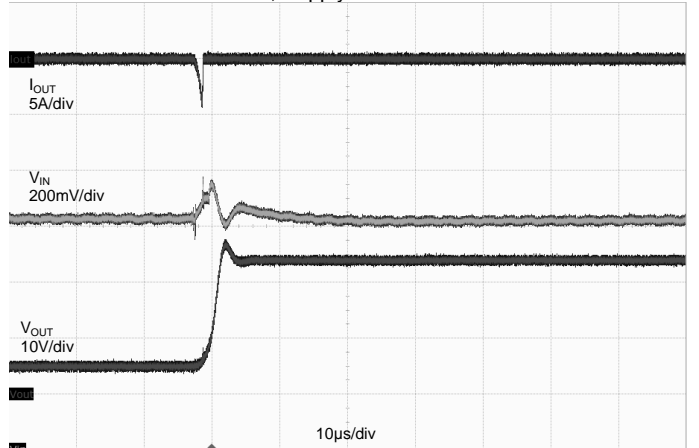

## Application Information

### General Description

The DPS1133 is a 1-channel power switch designed to meet the input and output voltage/current requirement that are common with many hot-pluggable serial interfaces found in the computing and consumer electronics equipment. For example, DPS1133 is compatible with the USB Power Delivery Specification Release 3.0, V1.0a, and many popular USB Type-C™ applications.

### Start-up Time

An external capacitor connected from the DV/DT pin to GND defines the slew rate of the output voltage at power-on:

$$dV_{OUT} / dt = (I_{DV/DT} / C_{DV/DT}) \times G_{DV/DT}$$

Where:

- $dV_{OUT} / dt$  is the desired output slew rate in V/ms
- $I_{DV/DT}$  is in  $\mu A$  and it is  $1\mu A$  typical
- $C_{DV/DT}$  is the ramp-up control setting capacitor in nF
- $G_{DV/DT}$  is the gain of DV/DT to OUT and  $G_{DV/DT} = 12$

The total ramp time  $t_{DV/DT}$  of  $V_{OUT}$  increasing from 0 to  $V_{IN}$  can be calculated using:

$$t_{DV/DT} = 8.3 \times 10^{-2} \times V_{IN} \times C_{DV/DT}$$

Where:

- $t_{DV/DT}$  is the total ramp time in ms
- The unit of  $V_{IN}$  is volt and  $C_{DV/DT}$  is nF.

Choosing a proper value for the capacitor  $C_{DV/DT}$  ensures that the device is turned ON with the preset ramp-up imposed over the output voltage. The in-rush current at power up is limited by the regulated output voltage ramp or the limited current setting.

C <sub>OUT</sub> (μF)	R <sub>LIM</sub> (kΩ)	I <sub>LIM_MIN</sub> (A)	I <sub>LOAD_MAX</sub> (A)	C <sub>DV/DT_MIN</sub> (nF)	Start-up Time (ms)		
					V <sub>IN</sub> = 5V	V <sub>IN</sub> = 12V	V <sub>IN</sub> = 20V
10	30	3.10	3	0.51	0.21	0.51	0.85
10	43	2.09	2	0.51	0.21	0.51	0.85
10	82	1.04	1	0.51	0.21	0.51	0.85
100	30	3.10	3	3.6	1.50	3.60	6.00
100	43	2.09	2	3.6	1.50	3.60	6.00
100	82	1.04	1	3.6	1.50	3.60	6.00

### Input Overvoltage Protection (OVP)

The voltage at the IN port is monitored continuously. Whenever voltage at the IN port is found to be larger than the  $V_{OVPRTH}$  value, the built-in overvoltage protection (OVP) fault-handling mechanism is triggered. The internal power MOSFET will be turned OFF to protect the downstream equipment connected. The  $V_{OVPRTH}$  value is determined by:

$$V_{OVPRTH} = 0.1 \times R_{VLIM} + 0.5$$

Where

- The unit of  $V_{OVPRTH}$  is volt
- $R_{VLIM}$  is kΩ and  $51k\Omega \leq R_{VLIM} \leq 270k\Omega$

### Reverse-Voltage Protection (RVP)

The voltage difference,  $[V_{IN} - V_{OUT}]$ , between the IN and OUT ports is monitored continuously. Once the voltage difference drops below the  $V_{RVPRTH}$  level, the device immediately turns OFF the internal power MOSFET to prevent the current flowing from the opposite direction. When the reverse-voltage condition is no longer valid, i.e.  $[V_{IN} - V_{OUT}]$  becomes greater than the  $V_{RVPRTH}$  level, the internal power MOSFET is turned ON.

## Application Information (Cont.)

### Overtemperature Protection (OTP)

During overload conditions, the output voltage would drop with the limited current  $I_{LIM}$ . It will result in the increasing junction temperature  $T_J$  with the increased power consumption on device. When  $T_J$  reaches to the thermal shutdown threshold  $T_{SHDN}$ , the internal power MOSFET would be turned OFF. The internal MOSFET would be turned ON again once the condition  $[T_J < (T_{SHDN} - T_{HYS})]$  occurs.

### Overcurrent Protection (OCP)

The output current is being monitored continuously. Whenever the output current  $I_{OUT}$  is found to be larger than the  $I_{LIM}$  value over  $2\mu s$ , the embedded overcurrent protection (OCP) fault-handling mechanism is triggered. This results in the output current being clamped at the  $I_{LIM}$  value at hundreds of microseconds later, and voltage dropping at OUT port. The  $I_{LIM}$  value is set by  $R_{ILIM}$ .

$$I_{LIM} = 100 / R_{ILIM}$$

Where:

- The unit of  $I_{LIM}$  is ampere
- $R_{ILIM}$  is k $\Omega$  and  $27k\Omega \leq R_{ILIM} \leq 200k\Omega$

$R_{ILIM}$ (k $\Omega$ )	$I_{LIM}$ (A)		
	Min	Typ	Max
200	0.50	0.55	0.7
100	0.90	1.05	1.20
66.7	1.35	1.50	1.65
50	1.80	2.00	2.20
40	2.25	2.50	2.75
33.3	2.76	3.00	3.24
28.6	3.22	3.50	3.78

### Short-Circuit Protection (SCP)

There are two behaviors to protect device under short-circuit conditions. One is fast trip current detection. When the output current exceeds the fast-trip threshold  $I_{FASTRIP}$ , the device will switch OFF the internal MOSFET,

$$I_{FASTRIP} = 1.125 \times I_{LIM} + 1.8$$

Where:

- The unit of  $I_{FASTRIP}$  and  $I_{LIM}$  is ampere

Another is low output voltage detection. During heavy overload or short circuit conditions, the output current is limited to  $I_{LIM}$  and the output voltage would drop quickly. When the output voltage drop is exceeded the capability of MOSFET, the power switch will be turned OFF. The device is operating in auto-retry mode and the cycle time is around 128ms.

### Adjustable Current Monitoring Output (IMON)

A 100pF capacitor and a resistor  $R_{IMON}$  connected in parallel between the IMON pin and GND will generate an average current monitor output voltage  $V_{IMON}$ , which is proportional to the load current flowing through the device,

$$V_{IMON} = 10^{-3} \times G_{IMON} \times R_{IMON} \times I_{OUT}$$

Where:

- $G_{IMON}$  is the ratio of the IMON to the load current in  $\mu A/A$  and  $G_{IMON} = 10$
- The unit of  $V_{IMON}$  is volt,  $R_{IMON}$  is k $\Omega$  and  $I_{OUT}$  is ampere

The resistor  $R_{IMON}$  should be chosen to ensure that the voltage at the IMON pin is less than 4.5V under the maximum load current  $I_{LIM}$ . For example, if  $R_{IMON}$  is selected as 100k $\Omega$ , there will be a 1V output on IMON pin at 1A load, and  $V_{IMON} = 3V$  at 3A load. Connecting this IMON pin to an ADC could help to monitor the current information of a system.

**Application Information** (Cont.)

**Fault Response**

An external pull-up resistor is required. The device generates a warning flag whenever one of the following fault conditions becomes valid: input overvoltage, reverse-voltage, overtemperature, short-circuit, overcurrent, and ILIM pin short to ground. After a de-glitch time-out of 7ms, the low-active FAULTB signal is asserted. The FAULTB signal remains at 'low' and the internal power MOSFET remains OFF until the device exits from the exception status.

**Support of Fast Role Swap (FRS)**

The DPS1133 is designed to support the Fast Role Swap (FRS) operation. This allows the system to change its role from being a power consumer to being a power provider within the time limit defined in the USB Power Delivery Specification Release 3.0 V1.0a. Irrespective of the voltage level at the EN pin, the relevant FRS control circuit inside the device is enabled at the rising edge of any positive pulse appearing at the FRS pin. When the pulse width ( $t_{FRS\_ON}$ ) is found to be larger than  $600\mu s$ , the internal power MOSFET is turned ON within  $60\mu s$  from the falling edge of the pulse in the absence of the reverse-voltage condition. At the end of the  $60\mu s$ , the voltage level at the OUT port is of 90% of the voltage level at the IN port. Thereafter, while a subsequent rising edge at the EN pin must always be ignored, the occurrence of a falling edge disables the device. After the device shuts down, it will not resume proper operation until a rising edge appears at either the EN pin or the FRS pin.

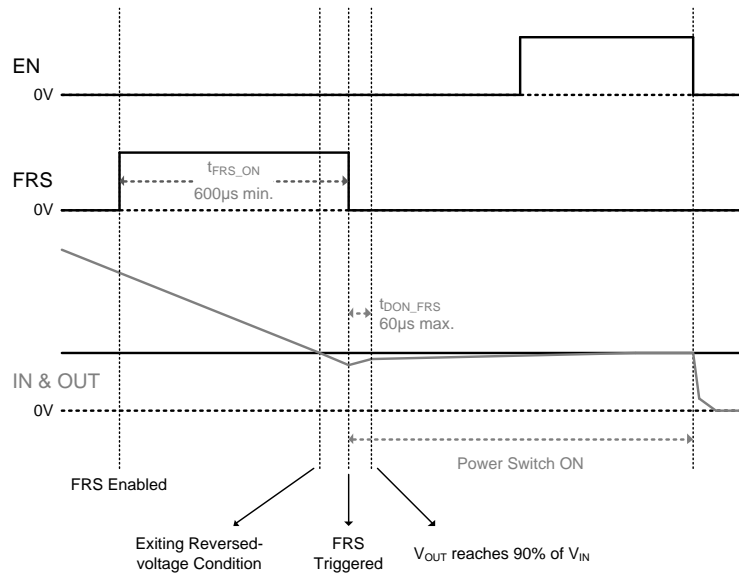

Figure 1. FRS Control Sequence for Fast Role Swap, Power Switch ON at Falling Edge of FRS Signal After Exiting RVP Condition

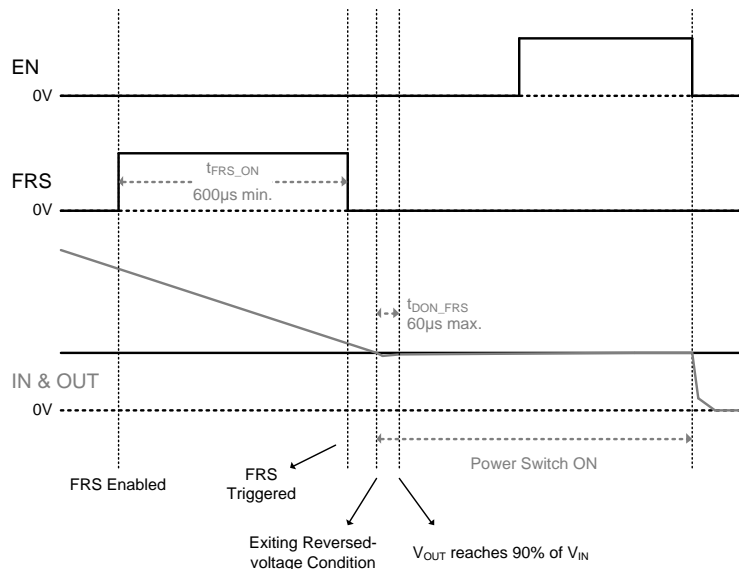

Figure 2. FRS Control Sequence for Fast Role Swap, Power Switch ON When Exiting RVP Condition after FRS is Triggered (Falling Edge)

## Application Information (Cont.)

### Discharge Function

To facilitate the various applications envisioned by the system designers, the input or output port can be discharged via two external controls: DISC1, DISC2. The internal discharge resistor at each port is approximately 100Ω. The discharge paths are OFF by default with an internal 1MΩ pull-down resistor between DISC1 (or DISC2) and GND. The settings are shown in the table below.

DISC1	DISC2	Description
0	0	Discharge function disabled
0	1	OUT port is being discharged until the pin DISC2 is pulled 'low'
1	0	IN port is being discharged until the pin DISC1 is pulled 'low'
1	1	Both IN and OUT ports are discharged simultaneously

### Schottky Diode for Protection of Current Surge

When a cable is hot plugged in/out of the USB-C connector behind which the OUT port of the DPS1133 is connected, a large ground current could be seen at the OUT port of the DPS1133. When the far end of a connected cable is short to ground for whatever reason, the OUT port of the DPS1133 could also see a large ground current. With the Schottky diode, SBR3U40P1, populated as close as possible to the USB-C connector, no ground current can go through the DPS1133 to cause false operation.

### PCB Layout Consideration

- Place the input/output capacitors  $C_{IN}$  and  $C_{OUT}$  as close as possible to the IN and OUT pins.
- The power traces, including the power ground, the  $V_{IN}$  trace and the  $V_{OUT}$  trace should be kept direct, short and wide.
- Place the resistors and capacitors ( $R_{VLIM}$ ,  $R_{ILIM}$ ,  $R_{IMON}$ ,  $C_{IMON}$ ,  $C_{DV/DT}$  and  $C_{VREG}$ ) near the device pins.
- Connect the signal ground to the GND pin, and keep a single connection from GND pin to the power ground behind the input or output capacitors.
- For better power dissipation, via holes are recommended to connect the exposed pad's landing area to a large copper polygon on the other side of the printed circuit board. The copper polygons and exposed pad of SRC (common source nodes of internal power MOSFET) must not be connected to any of the signal and power grounds on the printed circuit board.

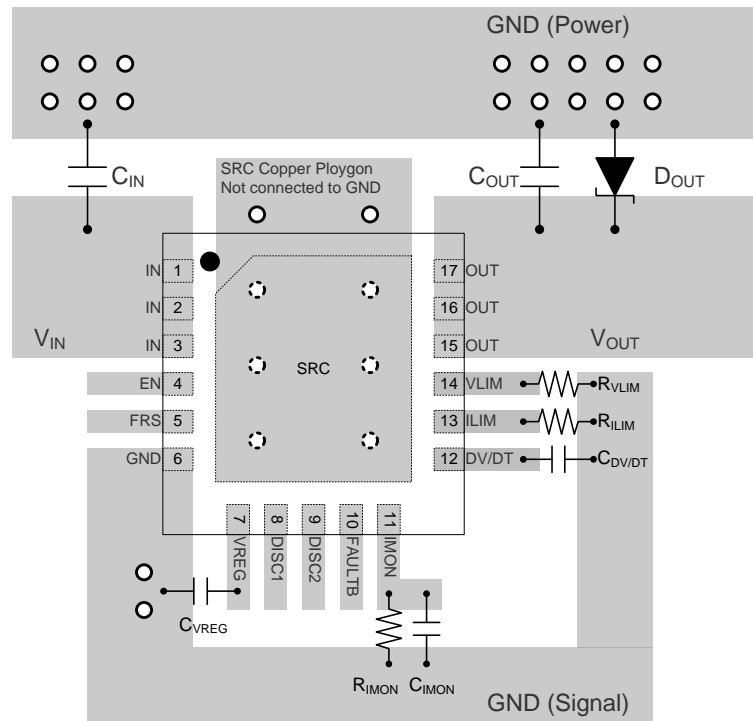
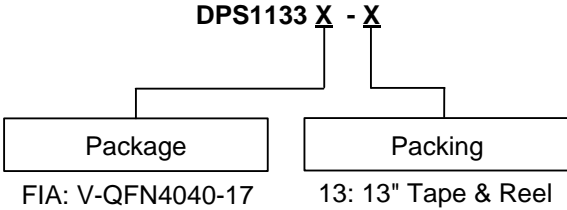

Figure 3. Suggested PCB Layout

**Ordering Information** (Note 6)



Part Number	Marking ID	Reel Size (inches)	Tape Width (mm)	13" Tape and Reel	
				Quantity	Part Number Suffix
DPS1133FIA-13	DPS1133	13	12	4000/Tape & Reel	-13

Note: 6. For packaging details, see <https://www.diodes.com/design/support/packaging/diodes-packaging/>.

**Marking Information**

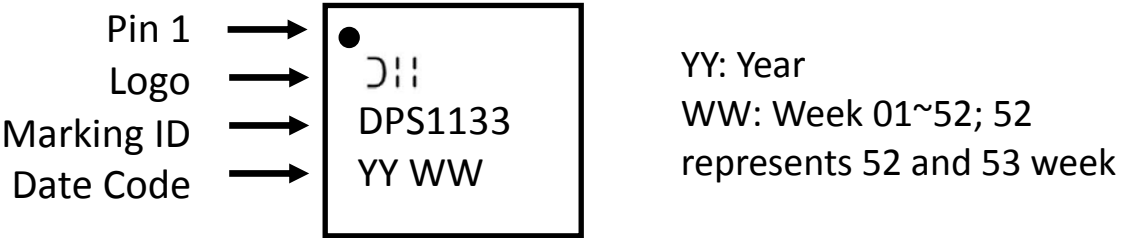

**Package Outline Dimensions**

Please see <http://www.diodes.com/package-outlines.html> for the latest version.

**V-QFN4040-17**

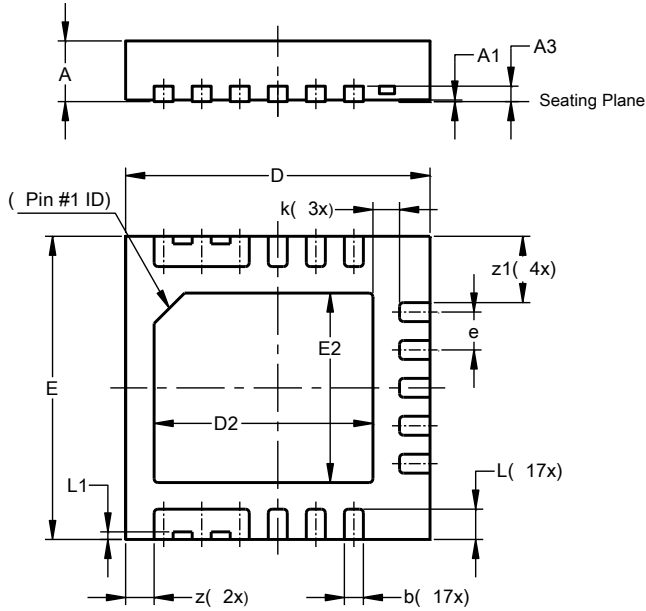

V-QFN4040-17			
Dim	Min	Max	Typ
A	0.75	0.85	0.80
A1	0.00	0.05	0.02
A3	—	—	0.203
b	0.20	0.30	0.25
D	3.95	4.05	4.00
D2	2.775	2.975	2.875
E	3.95	4.05	4.00
E2	2.40	2.60	2.50
e	0.50 BSC		
k	—	—	0.35
L1	—	—	0.10
L	0.35	0.45	0.40
z	—	—	0.38
z1	—	—	0.88
<b>All Dimensions in mm</b>			

**Suggested Pad Layout**

Please see <http://www.diodes.com/package-outlines.html> for the latest version.

**V-QFN4040-17**

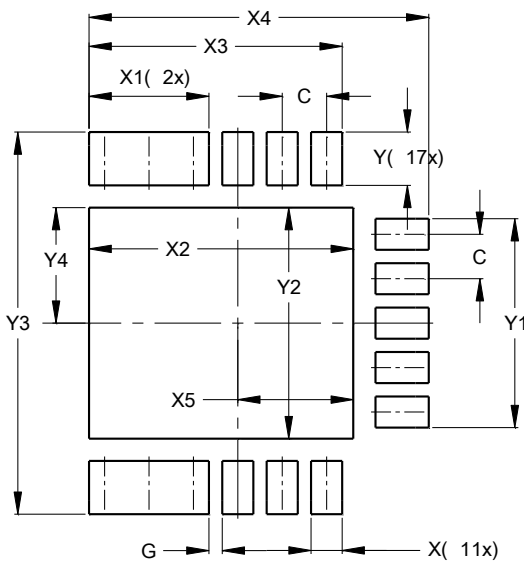

Dimensions	Value (in mm)
C	0.500
G	0.150
X	0.350
X1	1.350
X2	2.975
X3	2.850
X4	3.825
X5	1.300
Y	0.600
Y1	2.350
Y2	2.600
Y3	4.300
Y4	1.300

**IMPORTANT NOTICE**

DIODES INCORPORATED MAKES NO WARRANTY OF ANY KIND, EXPRESS OR IMPLIED, WITH REGARDS TO THIS DOCUMENT, INCLUDING, BUT NOT LIMITED TO, THE IMPLIED WARRANTIES OF MERCHANTABILITY AND FITNESS FOR A PARTICULAR PURPOSE (AND THEIR EQUIVALENTS UNDER THE LAWS OF ANY JURISDICTION).

Diodes Incorporated and its subsidiaries reserve the right to make modifications, enhancements, improvements, corrections or other changes without further notice to this document and any product described herein. Diodes Incorporated does not assume any liability arising out of the application or use of this document or any product described herein; neither does Diodes Incorporated convey any license under its patent or trademark rights, nor the rights of others. Any Customer or user of this document or products described herein in such applications shall assume all risks of such use and will agree to hold Diodes Incorporated and all the companies whose products are represented on Diodes Incorporated website, harmless against all damages.

Diodes Incorporated does not warrant or accept any liability whatsoever in respect of any products purchased through unauthorized sales channel. Should Customers purchase or use Diodes Incorporated products for any unintended or unauthorized application, Customers shall indemnify and hold Diodes Incorporated and its representatives harmless against all claims, damages, expenses, and attorney fees arising out of, directly or indirectly, any claim of personal injury or death associated with such unintended or unauthorized application.

Products described herein may be covered by one or more United States, international or foreign patents pending. Product names and markings noted herein may also be covered by one or more United States, international or foreign trademarks.

This document is written in English but may be translated into multiple languages for reference. Only the English version of this document is the final and determinative format released by Diodes Incorporated.

**LIFE SUPPORT**

Diodes Incorporated products are specifically not authorized for use as critical components in life support devices or systems without the express written approval of the Chief Executive Officer of Diodes Incorporated. As used herein:

A. Life support devices or systems are devices or systems which:

1. are intended to implant into the body, or
2. support or sustain life and whose failure to perform when properly used in accordance with instructions for use provided in the labeling can be reasonably expected to result in significant injury to the user.

B. A critical component is any component in a life support device or system whose failure to perform can be reasonably expected to cause the failure of the life support device or to affect its safety or effectiveness.

Customers represent that they have all necessary expertise in the safety and regulatory ramifications of their life support devices or systems, and acknowledge and agree that they are solely responsible for all legal, regulatory and safety-related requirements concerning their products and any use of Diodes Incorporated products in such safety-critical, life support devices or systems, notwithstanding any devices- or systems-related information or support that may be provided by Diodes Incorporated. Further, Customers must fully indemnify Diodes Incorporated and its representatives against any damages arising out of the use of Diodes Incorporated products in such safety-critical, life support devices or systems.

Copyright © 2019, Diodes Incorporated

[www.diodes.com](http://www.diodes.com)