

# DRV5032 Ultra-Low-Power Digital-Switch Hall Effect Sensor

## 1 Features

- Industry-leading ultra-low power consumption
  - 5Hz version: 0.54 $\mu$ A
  - 20Hz versions: 1.3 $\mu$ A
  - 80Hz version: 5.2 $\mu$ A
- Operating  $V_{CC}$  range: 1.65V to 5.5V
- Operating temperature range:  $-40^{\circ}\text{C}$  to  $+85^{\circ}\text{C}$
- Magnetic threshold options (maximum  $B_{OP}$ ):
  - DG Version: 3.4mT
  - DU Version: 3.9mT
  - FA, FB, FC, FD Versions: 4.8mT
  - AJ Version: 9.5mT
  - ZE Version: 63mT
- Omnipolar and unipolar options
- Open-drain and push-pull output options
- SOT-23, X2SON and TO-92 package options

## 2 Applications

- Battery-critical position sensing
- Electricity meter tamper detection
- Cell Phone, laptop, or tablet case sensing
- E-locks, smoke detectors, appliances
- Medical devices, IoT systems
- Valve or solenoid position detection
- Contactless diagnostics or activation

## 3 Description

The DRV5032 device is an ultra-low-power digital-switch Hall effect sensor, designed for the most compact and battery-sensitive systems. The device is offered in multiple magnetic thresholds, sampling rates, output drivers, and packages to accommodate various applications.

When the applied magnetic flux density exceeds the  $B_{OP}$  threshold, the device outputs a low voltage. The output stays low until the flux density decreases to less than  $B_{RP}$ , and then the output either drives a high voltage or becomes high impedance, depending on the device version. By incorporating an internal oscillator, the device samples the magnetic field and updates the output at a rate of 80Hz, 20Hz or 5Hz for the lowest current consumption. Omnipolar and unipolar magnetic responses are available.

The device operates from a  $V_{CC}$  range of 1.65V to 5.5V, and is packaged in a standard SOT-23, TO-92 and small X2SON.

### Package Information

PART NUMBER	PACKAGE <sup>(1)</sup>	PACKAGE SIZE <sup>(2)</sup>
DRV5032	DBZ (SOT-23, 3)	2.92mm × 2.37mm
	DMR (X2SON, 4)	1.4mm × 1.1mm
	LPG (TO-92, 3)	4mm × 1.52mm

- For all available packages, see the orderable addendum at the end of the data sheet.
- The package size (length × width) is a nominal value and includes pins, where applicable.

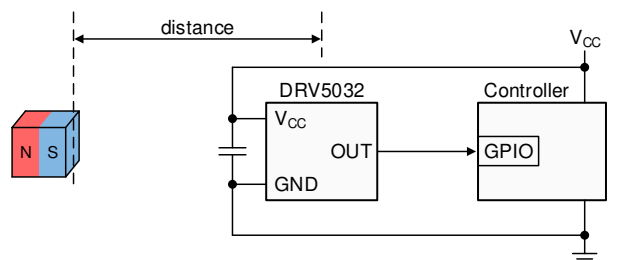

Copyright © 2017, Texas Instruments Incorporated

**Typical Schematic**

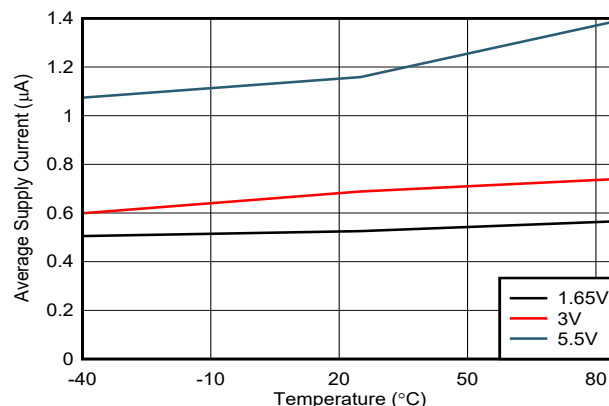

**Current Consumption of 5Hz Version**



## Table of Contents

<b>1 Features</b> .....	1	7.4 Device Functional Modes.....	15
<b>2 Applications</b> .....	1	<b>8 Application and Implementation</b> .....	16
<b>3 Description</b> .....	1	8.1 Application Information.....	16
<b>4 Device Comparison</b> .....	2	8.2 Typical Applications.....	16
<b>5 Pin Configuration and Functions</b> .....	3	8.3 Best Design Practices.....	20
<b>6 Specifications</b> .....	4	8.4 Power Supply Recommendations.....	21
6.1 Absolute Maximum Ratings.....	4	8.5 Layout.....	21
6.2 ESD Ratings.....	4	<b>9 Device and Documentation Support</b> .....	22
6.3 Recommended Operating Conditions.....	4	9.1 Documentation Support.....	22
6.4 Thermal Information.....	4	9.2 Receiving Notification of Documentation Updates.....	22
6.5 Electrical Characteristics.....	5	9.3 Support Resources.....	22
6.6 Magnetic Characteristics.....	6	9.4 Trademarks.....	22
6.7 Typical Characteristics.....	7	9.5 Electrostatic Discharge Caution.....	22
<b>7 Detailed Description</b> .....	10	9.6 Glossary.....	22
7.1 Overview.....	10	<b>10 Revision History</b> .....	22
7.2 Functional Block Diagram.....	10	<b>11 Mechanical, Packaging, and Orderable Information</b> .....	23
7.3 Feature Description.....	11		

## 4 Device Comparison

**Table 4-1. Device Comparison**

VERSION	MAXIMUM THRESHOLD	MAGNETIC RESPONSE	OUTPUT TYPE	SAMPLING RATE	PACKAGES AVAILABLE
DRV5032DG	3.4 mT	Unipolar	Push-pull	80 Hz	X2SON
DRV5032DU	3.9 mT	Unipolar	Push-pull	20 Hz	SOT-23, X2SON, TO-92
DRV5032FA	4.8 mT	Omnipolar	Push-pull	20 Hz	SOT-23, X2SON, TO-92
DRV5032FB		Omnipolar	Push-pull	5 Hz	SOT-23, X2SON <sup>(1)</sup> , TO-92
DRV5032FC		Omnipolar	Open-drain	20 Hz	SOT-23, TO-92
DRV5032FD		Unipolar	Push-pull	20 Hz	X2SON, TO-92
DRV5032AJ	9.5 mT	Omnipolar	Open-drain	20 Hz	SOT-23, X2SON, TO-92
DRV5032ZE	63 mT	Omnipolar	Open-drain	20 Hz	SOT-23, TO-92

(1) Preview information (not Production Data).

## 5 Pin Configuration and Functions

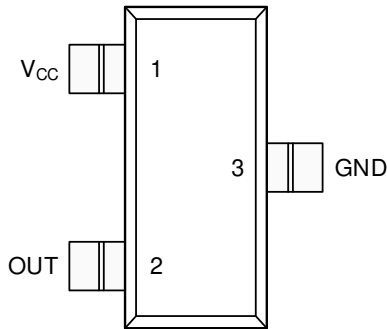

Figure 5-1. FA, FB, FC, AJ, ZE Versions DBZ Package 3-Pin SOT-23 Top View

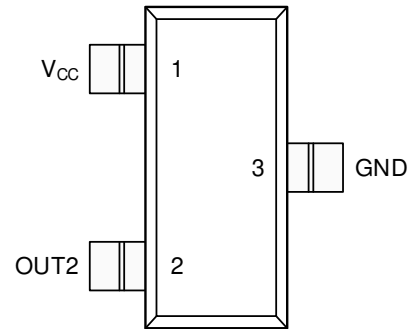

Figure 5-2. DU Version DBZ Package 3-Pin SOT-23 Top View

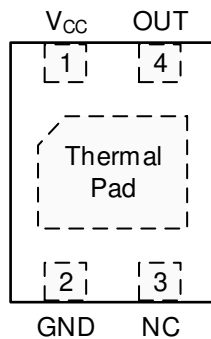

Figure 5-3. FA, AJ Versions DMR Package 4-Pin X2SON Top View

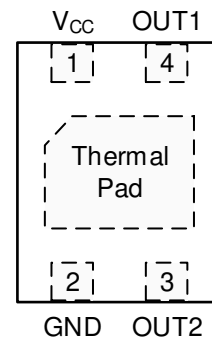

Figure 5-4. DU, DG, FD Versions DMR Package 4-Pin X2SON Top View

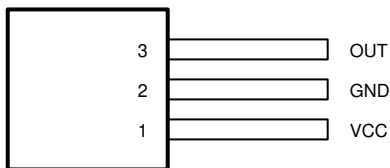

Figure 5-5. FA, FB, FC, AJ, ZE Versions LPG Package 3-Pin TO-92 Top View

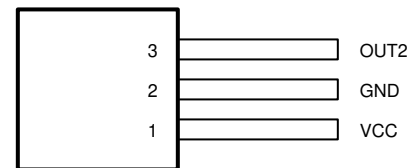

Figure 5-6. DU, FD Versions LPG Package 3-Pin TO-92 Top View

Table 5-1. Pin Functions

NAME	PIN						I/O	DESCRIPTION
	SOT-23 (FA, FB, FC, AJ, ZE)	SOT-23 (DU)	TO-92 (FA, FB, FC, AJ, ZE)	TO-92 (DU, FD)	X2SON (FA, AJ)	X2SON (DU, DG, FD)		
GND	3	3	2	2	2	2	—	Ground reference
OUT	2	—	3	—	4	—	O	Omnipolar output that responds to north and south magnetic poles
OUT1	—	—	—	—	—	4	O	Unipolar output that responds to north magnetic poles near the top of the package
OUT2	—	2	—	3	—	3	O	Unipolar output that responds to south magnetic poles near the top of the package
NC	—	—	—	—	3	—	—	No-connect. This pin is not connected to the silicon. Leave this pin floating or tied to ground. Solder the pin to the board for mechanical support.
V <sub>CC</sub>	1	1	1	1	1	1	—	1.65-V to 5.5-V power supply. TI recommends connecting this pin to a ceramic capacitor to ground with a value of at least 0.1 μF.
Thermal Pad	—	—	—	—	PAD	PAD	—	No-connect. Leave this pin floating or tied to ground. Solder the pin to the board for mechanical support.

## 6 Specifications

### 6.1 Absolute Maximum Ratings

over operating free-air temperature range (unless otherwise noted)<sup>(1)</sup>

		MIN	MAX	UNIT
Power supply voltage	V <sub>CC</sub>	-0.3	5.5	V
Power supply voltage slew rate	V <sub>CC</sub>	Unlimited		V / $\mu$ s
Output voltage	OUT, OUT1, OUT2	-0.3	V <sub>CC</sub> + 0.3	V
Output current	OUT, OUT1, OUT2	-5	5	mA
Magnetic flux density, B <sub>MAX</sub>		Unlimited		T
Junction temperature, T <sub>J</sub>			105	°C
Storage temperature, T <sub>stg</sub>		-65	150	°C

- (1) Stresses beyond those listed under *Absolute Maximum Ratings* may cause permanent damage to the device. These are stress ratings only, which do not imply functional operation of the device at these or any other conditions beyond those indicated under *Recommended Operating Conditions*. Exposure to absolute-maximum-rated conditions for extended periods may affect device reliability.

### 6.2 ESD Ratings

			VALUE	UNIT
V <sub>(ESD)</sub>	Electrostatic discharge	Human-body model (HBM), per ANSI/ESDA/JEDEC JS-001 <sup>(1)</sup>	±6000	V
		Charged-device model (CDM), per JEDEC specification JESD22-C101 <sup>(2)</sup>	±750	

- (1) JEDEC document JEP155 states that 500-V HBM allows safe manufacturing with a standard ESD control process.  
 (2) JEDEC document JEP157 states that 250-V CDM allows safe manufacturing with a standard ESD control process.

### 6.3 Recommended Operating Conditions

over operating free-air temperature range (unless otherwise noted)

		MIN	MAX	UNIT
V <sub>CC</sub>	Power supply voltage	1.65	5.5	V
V <sub>O</sub>	Output voltage	0	5.5	V
I <sub>O</sub>	Output current	-5	5	mA
T <sub>A</sub>	Operating ambient temperature	-40	85	°C

### 6.4 Thermal Information

THERMAL METRIC <sup>(1)</sup>		DRV5032			UNIT
		DBZ (SOT-23)	DMR (X2SON)	LPG (TO-92)	
		3 PINS	4 PINS	3 PINS	
R <sub>θJA</sub>	Junction-to-ambient thermal resistance	356	159	183.1	°C/W
R <sub>θJC(top)</sub>	Junction-to-case (top) thermal resistance	128	77	74.2	°C/W
R <sub>θJB</sub>	Junction-to-board thermal resistance	94	102	158.8	°C/W
Ψ <sub>JT</sub>	Junction-to-top characterization parameter	11.4	0.9	15.2	°C/W
Ψ <sub>JB</sub>	Junction-to-board characterization parameter	92	100	158.8	°C/W

- (1) For more information about traditional and new thermal metrics, see the [Semiconductor and IC Package Thermal Metrics](#) application note.

## 6.5 Electrical Characteristics

for  $V_{CC} = 1.65V$  to  $5.5V$ , over operating free-air temperature range (unless otherwise noted)

PARAMETER		TEST CONDITIONS	MIN	TYP	MAX	UNIT
<b>PUSH-PULL OUTPUT DRIVER</b>						
$V_{OH}$	High-level output voltage	$I_{OUT} = -1mA$	$V_{CC} - 0.35$	$V_{CC} - 0.1$		V
$V_{OL}$	Low-level output voltage	$I_{OUT} = 1mA$		0.1	0.3	V
<b>OPEN-DRAIN OUTPUT</b>						
$I_{OZ}$	High impedance output leakage current	$V_{CC} = 5.5V, OUT = 5.5V$		5	100	nA
$V_{OL}$	Low-level output voltage	$I_{OUT} = 1mA$		0.1	0.3	V
<b>DG VERSION</b>						
$f_s$	Frequency of magnetic sampling		40	80	120	Hz
$t_s$	Period of magnetic sampling		8	12.5	25	ms
$I_{CC(AVG)}$	Average current consumption	$V_{CC} = 1.8V$		5.2		$\mu A$
		$V_{CC} = 3V$		5.7	7.9	
		$V_{CC} = 5V$		6		
<b>DU, FA, FC, FD, AJ, ZE VERSIONS</b>						
$f_s$	Frequency of magnetic sampling		13.3	20	37	Hz
$t_s$	Period of magnetic sampling		27	50	75	ms
$I_{CC(AVG)}$	Average current consumption	$V_{CC} = 1.8V$		1.3		$\mu A$
		$V_{CC} = 3V$		1.6	3.5	
		$V_{CC} = 5V$		2.3		
<b>FB VERSION</b>						
$f_s$	Frequency of magnetic sampling		3.5	5	8.5	Hz
$t_s$	Period of magnetic sampling		117	200	286	ms
$I_{CC(AVG)}$	Average current consumption	$V_{CC} = 1.8V$		0.54		$\mu A$
	Average current consumption	$V_{CC} = 3V$		0.69	1.8	
	Average current consumption	$V_{CC} = 5V$		1.06		
<b>ALL VERSIONS</b>						
$I_{CC(PK)}$	Peak current consumption			2	2.7	mA
$t_{ON}$	Power-on time (see <a href="#">Figure 8-7</a> )			55	100	$\mu s$
$t_{ACTIVE}$	Active time period (see <a href="#">Figure 8-7</a> )			40		$\mu s$

## 6.6 Magnetic Characteristics

for  $V_{CC} = 1.65V$  to  $5.5V$ , over operating free-air temperature range (unless otherwise noted)<sup>(1)</sup>

PARAMETER		TEST CONDITIONS	MIN	TYP	MAX	UNIT
<b>DG VERSION</b>						
$B_{OP}$	Magnetic threshold operate point	OUT1 pin (north) <sup>(2)</sup> $T_A = 25C$	-3.32	-2.5	-1.72	mT
		OUT1 pin (north) <sup>(2)</sup>	-3.40	-2.5	-1.56	
		OUT2 pin (south) $T_A = 25C$	1.72	2.5	3.32	
		OUT2 pin (south)	1.56	2.5	3.40	
$B_{RP}$	Magnetic threshold release point	OUT1 pin (north) <sup>(2)</sup> $T_A = 25C$	-2.62	-1.8	-1.17	mT
		OUT1 pin (north) <sup>(2)</sup>	-2.73	-1.8	-0.9	
		OUT2 pin (south) $T_A = 25C$	1.17	1.8	2.62	
		OUT2 pin (south)	0.9	1.8	2.73	
$B_{HYS}$	Magnetic hysteresis: $ B_{OP} - B_{RP} $	Each output $T_A = 25C$	0.21	0.7	1.19	mT
	Magnetic hysteresis: $ B_{OP} - B_{RP} $	Each output	0.13	0.7	1.27	
<b>DU VERSION</b>						
$B_{OP}$	Magnetic threshold operate point	OUT1 pin (north) <sup>(2)</sup>	-3.9	-2.5	-1.2	mT
	Magnetic threshold operate point	OUT2 pin (south)	1.2	2.5	3.9	
$B_{RP}$	Magnetic threshold release point	OUT1 pin (north) <sup>(2)</sup>	-3.5	-1.8	-0.9	mT
	Magnetic threshold release point	OUT2 pin (south)	0.9	1.8	3.5	
$B_{HYS}$	Magnetic hysteresis: $ B_{OP} - B_{RP} $	Each output	0.1	0.7	1.9	mT
<b>FA, FB, FC VERSIONS</b>						
$B_{OP}$	Magnetic threshold operate point		±1.5	±3	±4.8	mT
$B_{RP}$	Magnetic threshold release point		±0.5	±1.5	±3	mT
$B_{HYS}$	Magnetic hysteresis: $ B_{OP} - B_{RP} $		0.8	1.5	3	mT
<b>FD VERSION</b>						
$B_{OP}$	Magnetic threshold operate point	OUT1 pin (north) <sup>(2)</sup>	-4.8	-3	-1.5	mT
		OUT2 pin (south)	1.5	3	4.8	
$B_{RP}$	Magnetic threshold release point	OUT1 pin (north) <sup>(2)</sup>	-3	-1.5	-0.5	mT
		OUT2 pin (south)	0.5	1.5	3	
$B_{HYS}$	Magnetic hysteresis: $ B_{OP} - B_{RP} $	Each output	0.8	1.5	3	mT
<b>AJ VERSION</b>						
$B_{OP}$	Magnetic threshold operate point		±4	±7	±9.5	mT
$B_{RP}$	Magnetic threshold release point		±3	±5.6	±7.5	mT
$B_{HYS}$	Magnetic hysteresis: $ B_{OP} - B_{RP} $		0.5	1.4	3	mT
<b>ZE VERSION</b>						
$B_{OP}$	Magnetic threshold operate point		±33	±47	±63	mT
$B_{RP}$	Magnetic threshold release point		±30	±43	±58	mT
$B_{HYS}$	Magnetic hysteresis: $ B_{OP} - B_{RP} $		1.2	4	8.5	mT

(1) For a graphical description of magnetic thresholds, see the [Magnetic Response](#) section.

(2) X2SON package only.

## 6.7 Typical Characteristics

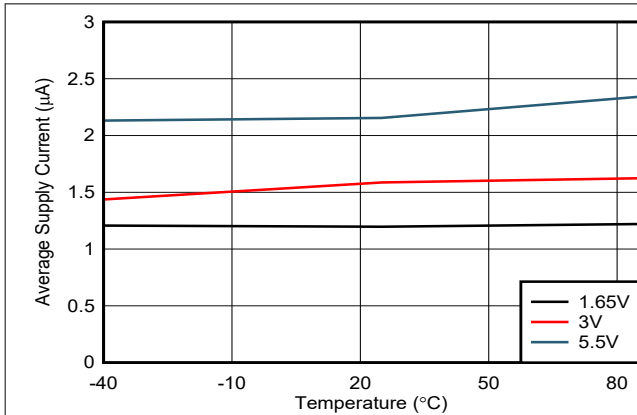

Figure 6-1.  $I_{CC(AVG)}$  vs Temperature (20-Hz versions)

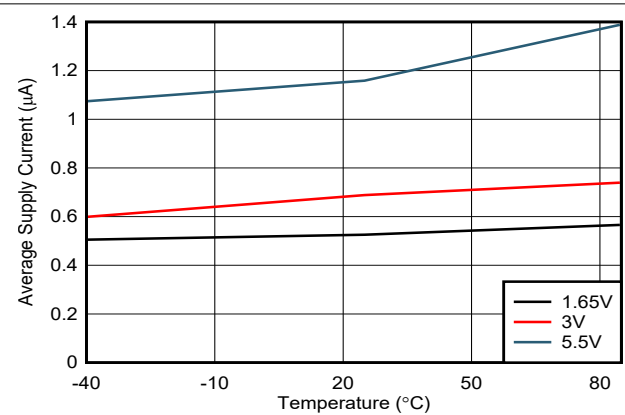

Figure 6-2.  $I_{CC(AVG)}$  vs Temperature (5-Hz version)

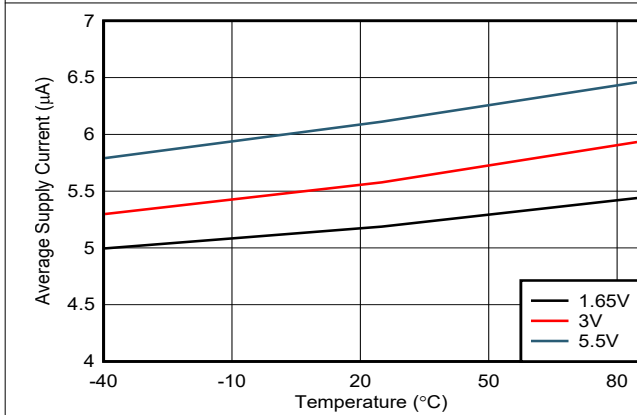

Figure 6-3.  $I_{CC(AVG)}$  vs Temperature (40-Hz version)

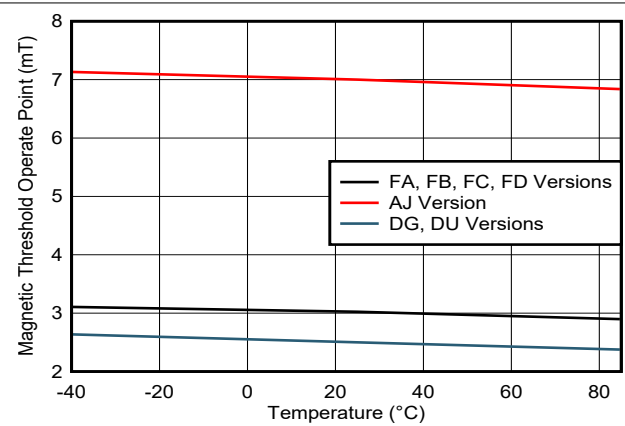

Figure 6-4.  $|B_{OP}|$  vs Temperature

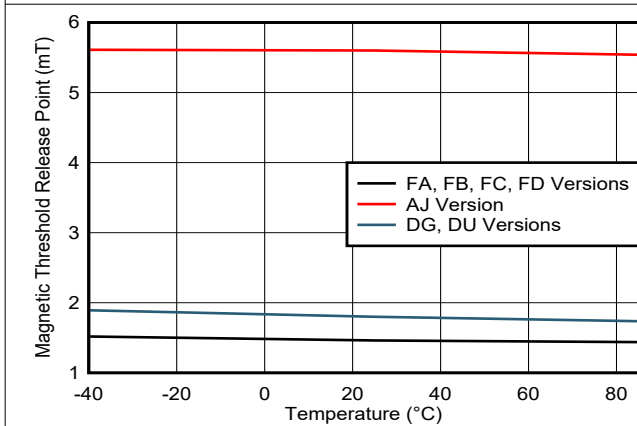

Figure 6-5.  $|B_{RP}|$  vs Temperature

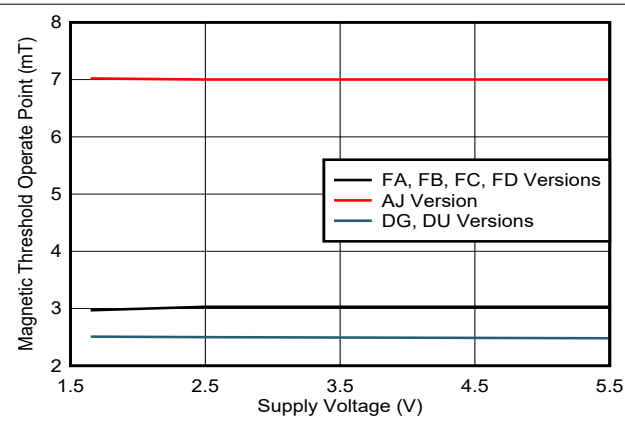
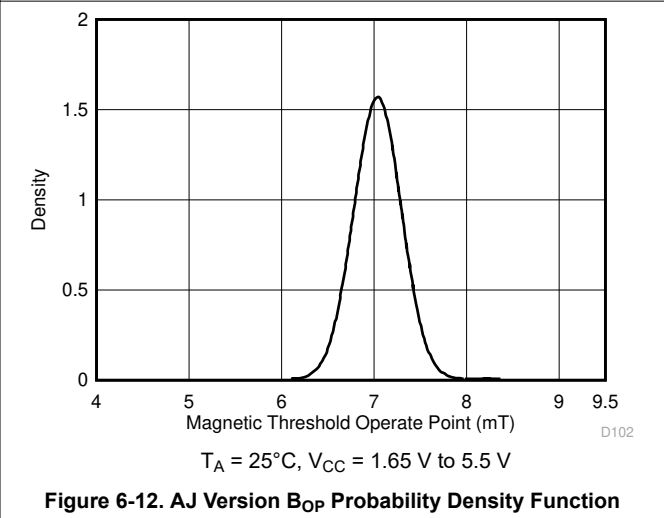
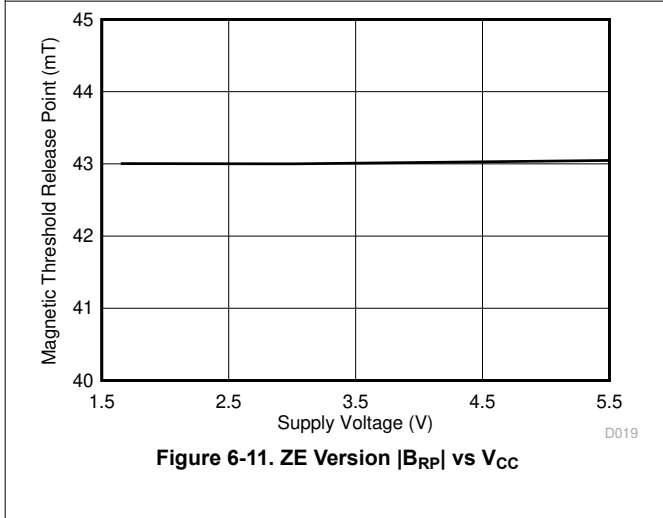
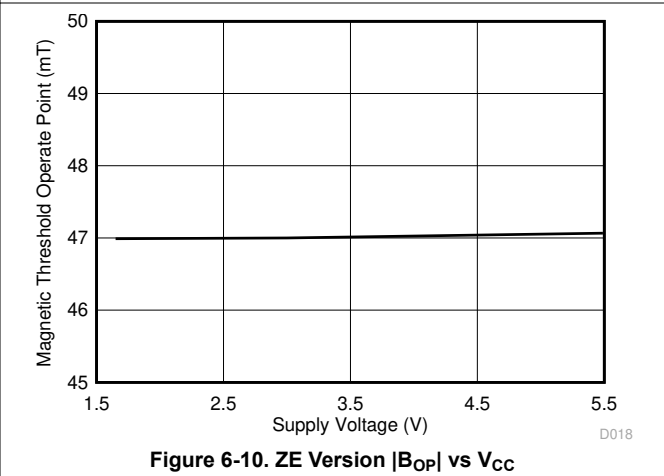
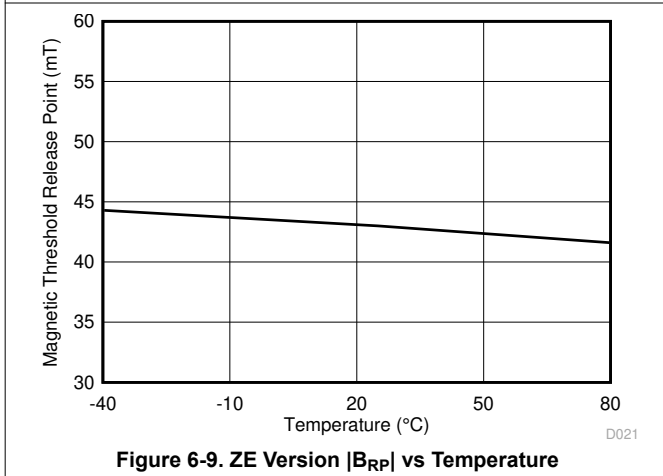
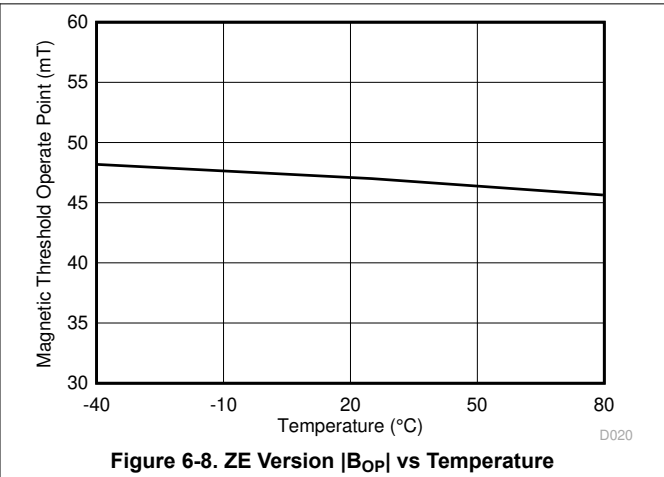
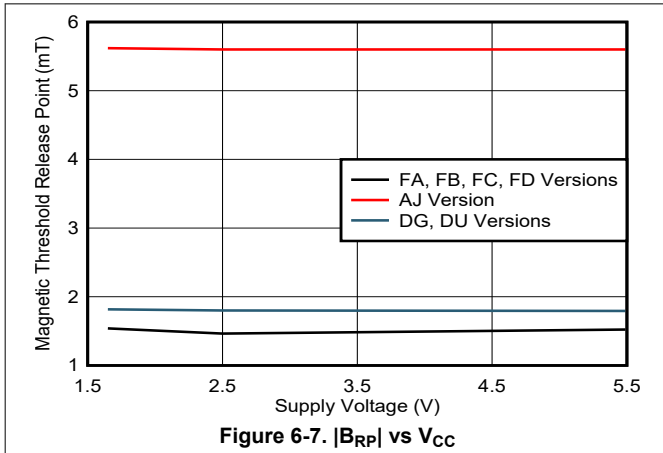

Figure 6-6.  $|B_{OP}|$  vs  $V_{CC}$

### 6.7 Typical Characteristics (continued)





### 6.7 Typical Characteristics (continued)

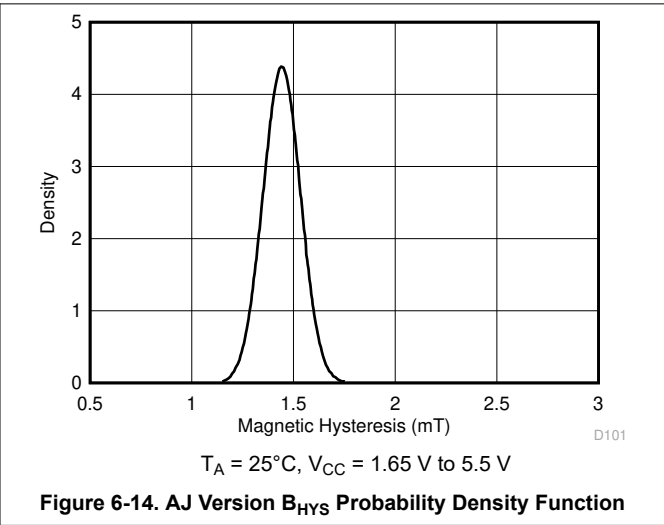
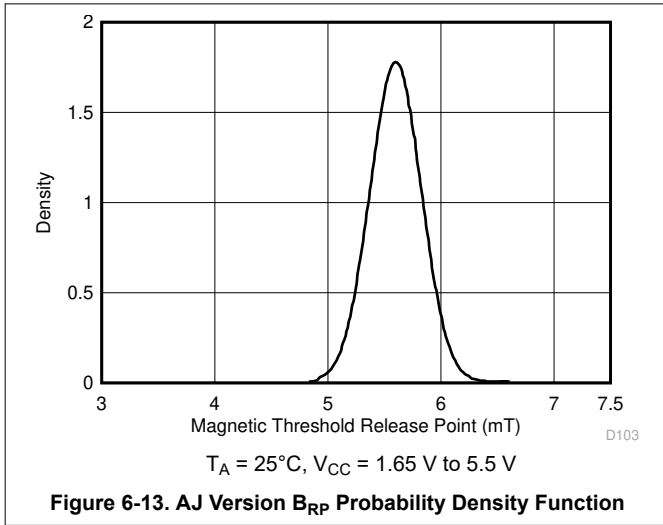

## 7 Detailed Description

### 7.1 Overview

The DRV5032 device is a magnetic sensor with a digital output that indicates when the magnetic flux density threshold has been crossed. The device integrates a Hall effect element, analog signal conditioning, and a low-frequency oscillator that enables ultra-low average power consumption. By operating from a 1.65-V to 5.5-V supply, the device periodically measures magnetic flux density, updates the output, and enters a low-power sleep state.

### 7.2 Functional Block Diagram

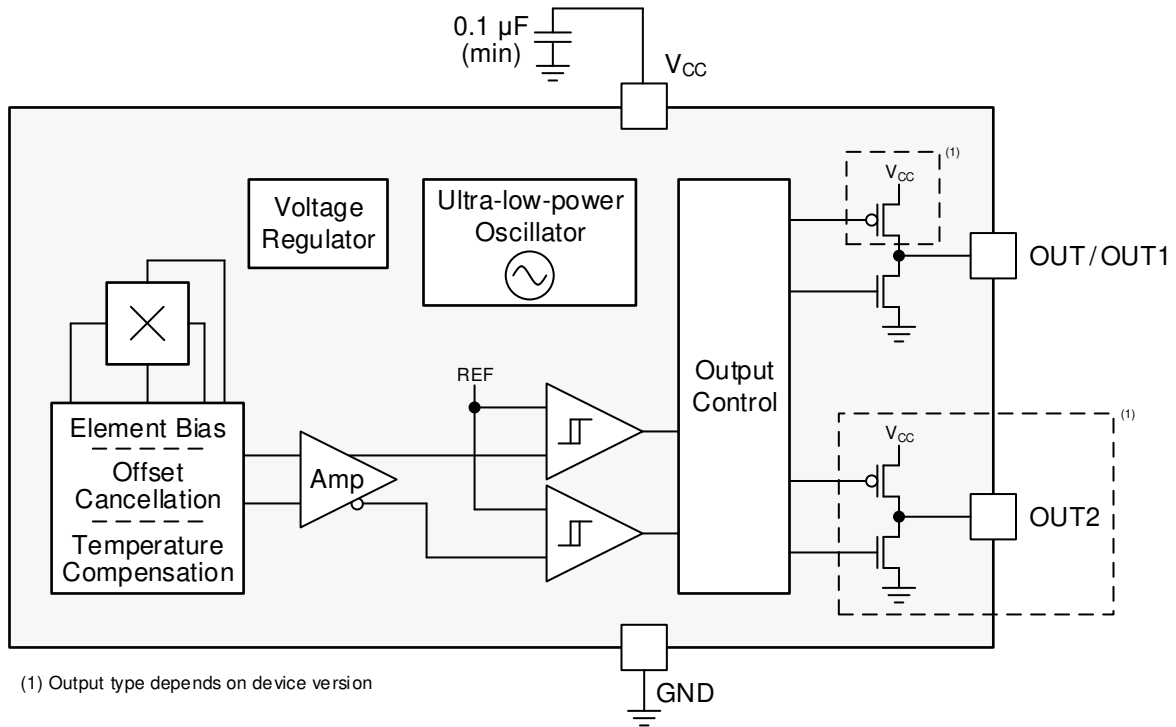

Copyright © 2017, Texas Instruments Incorporated

## 7.3 Feature Description

### 7.3.1 Magnetic Flux Direction

The DRV5032 device is sensitive to the magnetic field component that is perpendicular to the top of the package (as shown in Figure 7-1).

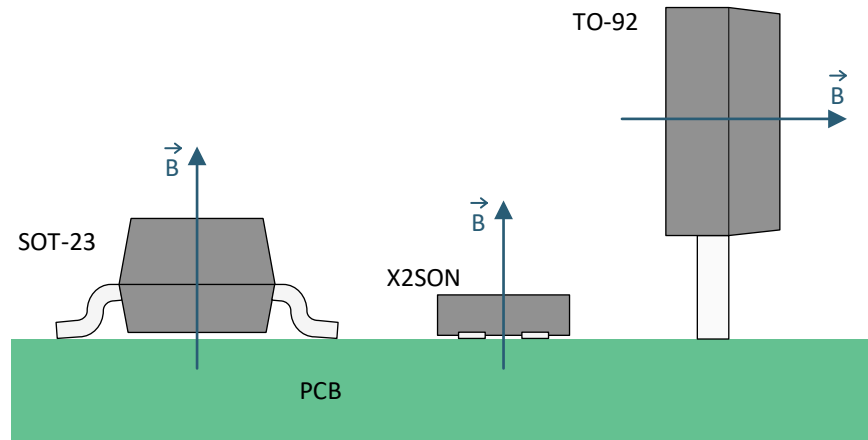

Figure 7-1. Direction of Sensitivity

The magnetic flux that travels from the bottom to the top of the package is considered positive in this data sheet. This condition exists when a south magnetic pole is near the top of the package. The magnetic flux that travels from the top to the bottom of the package results in negative millitesla values.

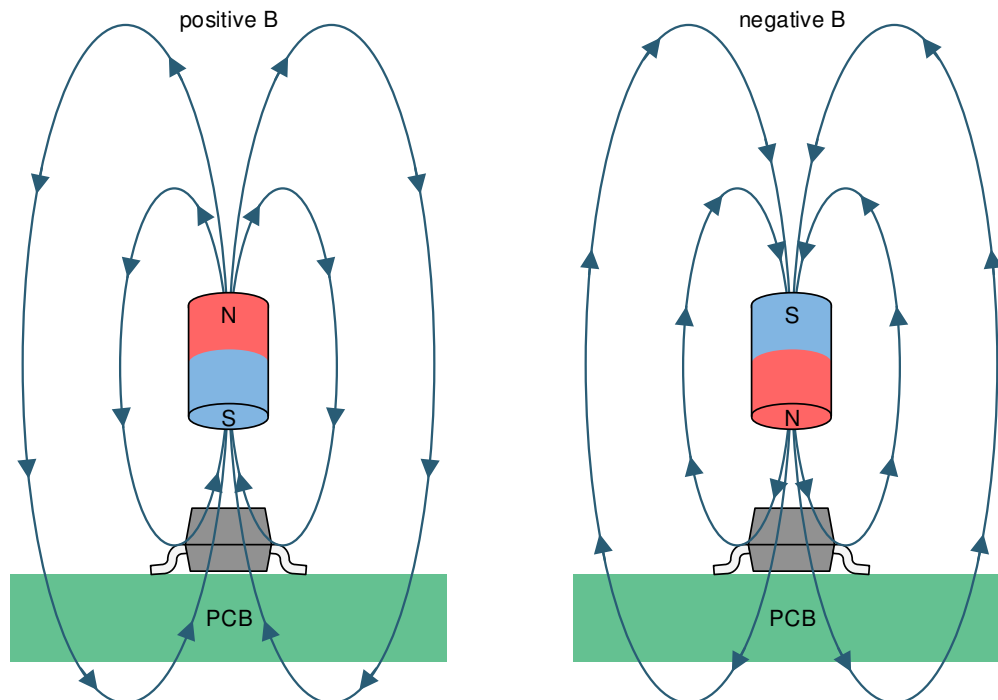

Figure 7-2. Flux Direction Polarity

### 7.3.2 Device Version Comparison

The following table lists the available device versions.

VERSION	MAXIMUM THRESHOLD	MAGNETIC RESPONSE	OUTPUT TYPE	SAMPLING RATE	PACKAGES AVAILABLE
DRV5032DG	3.4 mT	Unipolar	Push-pull	80 Hz	X2SON
DRV5032DU	3.9 mT	Unipolar	Push-pull	20 Hz	SOT-23, X2SON, TO-92
DRV5032FA	4.8 mT	Omnipolar	Push-pull	20 Hz	SOT-23, X2SON, TO-92
DRV5032FB		Omnipolar	Push-pull	5 Hz	SOT-23, X2SON <sup>(1)</sup> , TO-92
DRV5032FC		Omnipolar	Open-drain	20 Hz	SOT-23, TO-92
DRV5032FD		Unipolar	Push-pull	20 Hz	X2SON, TO-92
DRV5032AJ		9.5 mT	Omnipolar	Open-drain	20 Hz
DRV5032ZE	63 mT	Omnipolar	Open-drain	20 Hz	SOT-23, TO-92

(1) Preview information (not Production Data).

#### 7.3.2.1 Magnetic Threshold

Devices that have a lower magnetic threshold detect magnets at a farther distance. Higher thresholds generally require a closer distance or larger magnet.

#### 7.3.2.2 Magnetic Response

The FA, FB, FC, AJ, and ZE device versions have omnipolar functionality, and these versions all respond to the north and south poles the same way as shown in [Figure 7-3](#).

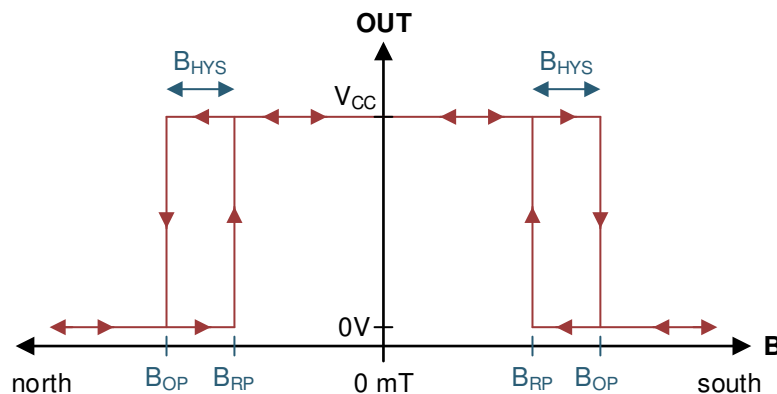

**Figure 7-3. Omnipolar Functionality**

The DU, DG and FD device versions have unipolar functionality. Pin OUT1 only responds to flux in the top-down direction (north), and pin OUT2 only responds to flux in the bottom-up direction (south).

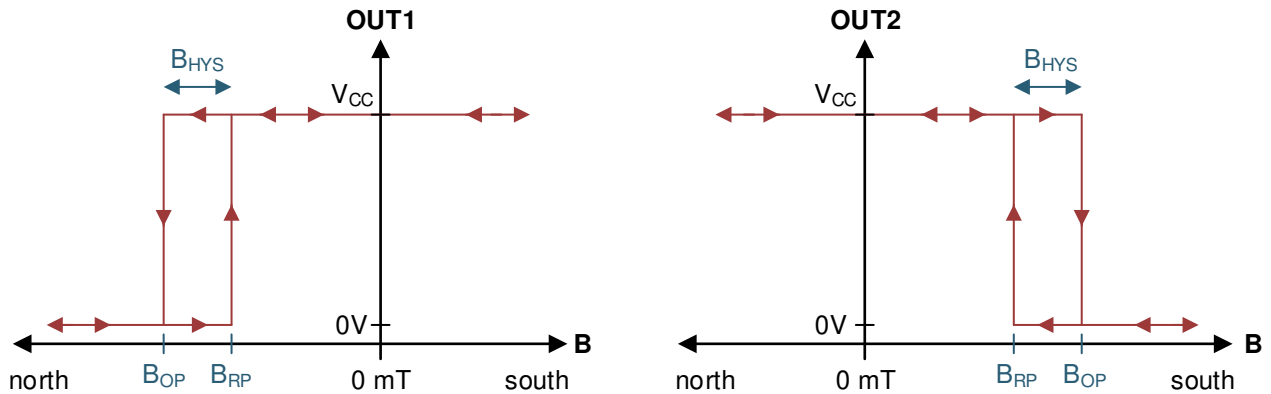

Figure 7-4. Unipolar Functionality

### 7.3.2.3 Output Type

The DU, DG, FA, FB, and FD device versions have push-pull CMOS outputs that can drive a V<sub>CC</sub> or ground level. The FC, AJ, and ZE device versions have open-drain outputs that can become high impedance or drive ground. For these versions, an external pullup resistor must be used.

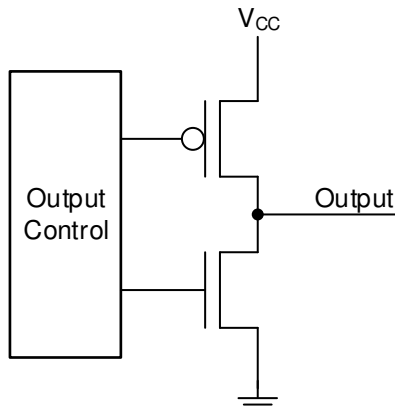

Figure 7-5. Push-Pull Output (Simplified)

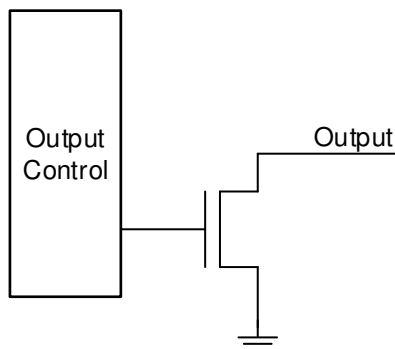

Figure 7-6. Open-Drain Output (Simplified)

### 7.3.2.4 Sampling Rate

When the DRV5032 device powers up, it measures the first magnetic sample and sets the output within the t<sub>ON</sub> time. The output is latched, and the device enters an ultra-low-power sleep state. After each t<sub>S</sub> time, the device measures a new sample and updates the output, if necessary. If the magnetic field does not change between periods, the output does not change.

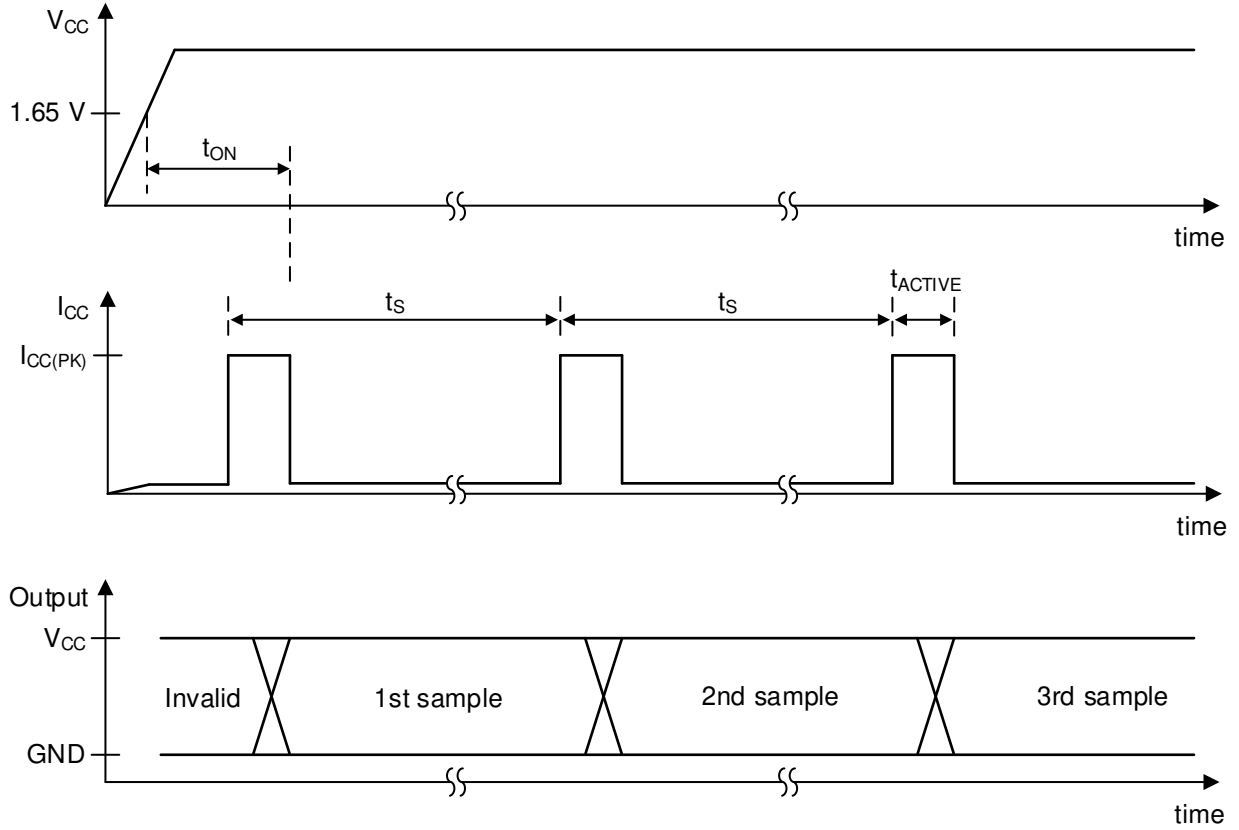
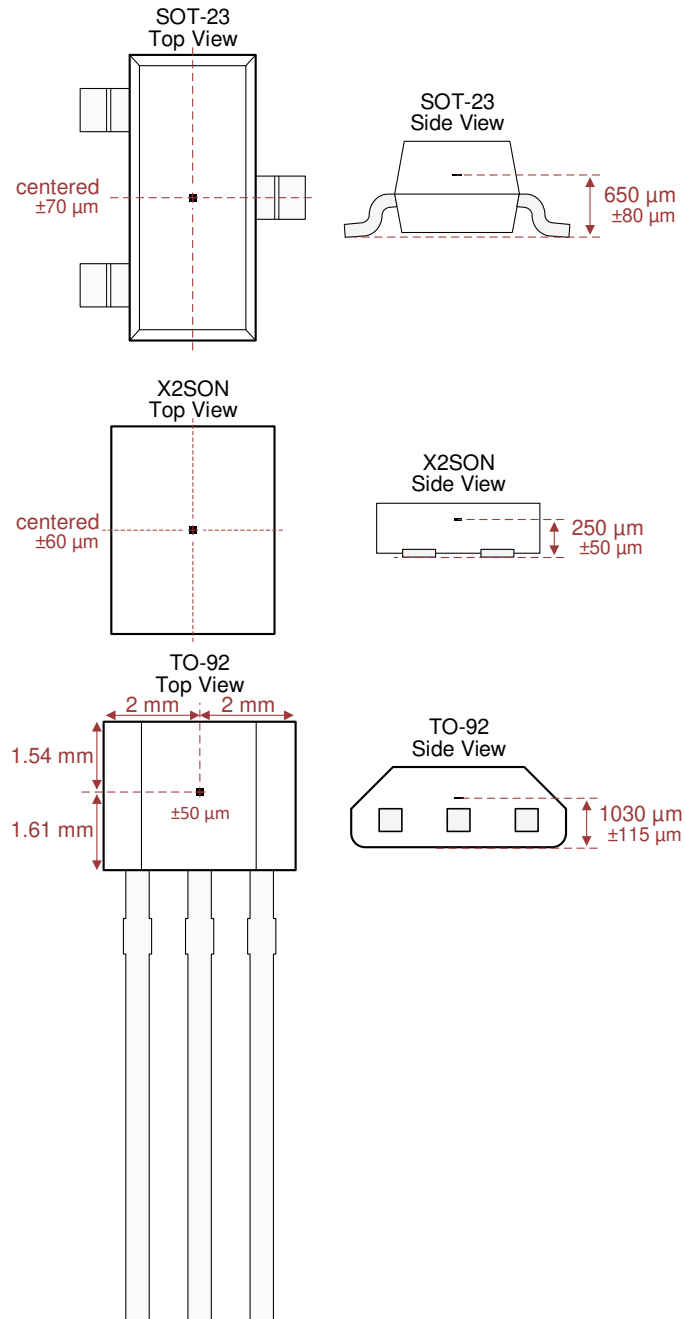

Figure 7-7. Timing Diagram

### 7.3.3 Hall Element Location

The sensing element inside the device is in the center of both packages when viewed from the top. Figure 7-8 shows the tolerances and side-view dimensions.



**Figure 7-8. Hall Element Location**

### 7.4 Device Functional Modes

The DRV5032 device has one mode of operation that applies when the *Recommended Operating Conditions* are met.

## 8 Application and Implementation

### Note

Information in the following applications sections is not part of the TI component specification, and TI does not warrant its accuracy or completeness. TI's customers are responsible for determining suitability of components for their purposes, as well as validating and testing their design implementation to confirm system functionality.

### 8.1 Application Information

The DRV5032 device is typically used to detect the proximity of a magnet. The magnet is often attached to a movable component in the system.

#### 8.1.1 Output Type Tradeoffs

The push-pull output allows for the lowest system power consumption because there is no current leakage path when the output drives high or low. The open-drain output involves a leakage path through the external pullup resistor when the output drives low.

The open-drain outputs of multiple devices can be tied together to form a logical AND. In this setup, if any sensor drives low, the voltage on the shared node becomes low. This can allow a single GPIO to measure an array of sensors.

### 8.2 Typical Applications

#### 8.2.1 General-Purpose Magnet Sensing

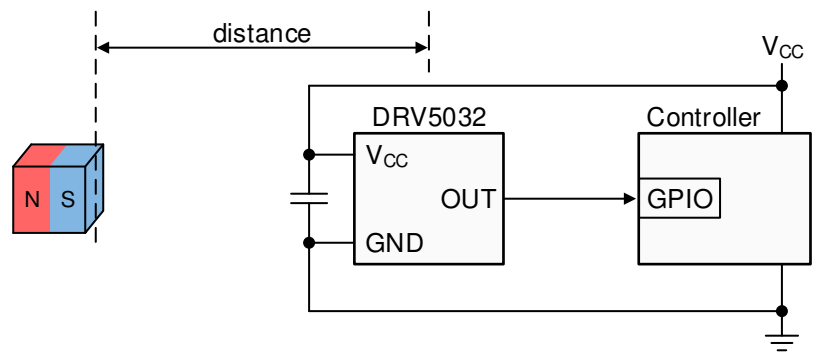

Copyright © 2017, Texas Instruments Incorporated

**Figure 8-1. Typical Application Diagram**

##### 8.2.1.1 Design Requirements

For this design example, use the parameters listed in [Table 8-1](#).

**Table 8-1. Design Parameters**

DESIGN PARAMETER	EXAMPLE VALUE
V <sub>CC</sub>	3.3 V
Magnet	1-cm Cube NdFeB
Closest magnet distance	2.5 cm
Magnetic flux density at closest distance	7.8 mT
Magnetic flux density when magnet moves away	Close to 0 mT

##### 8.2.1.2 Detailed Design Procedure

When designing a digital-switch magnetic sensing system, consider these three variables: the magnet, sensing distance, and threshold of the sensor.



The DRV5032 device has a detection threshold specified by parameter  $B_{OP}$ . To reliably activate the sensor, the magnet must apply greater than the maximum specified  $B_{OP}$ . In such a system, the sensor typically detects the magnet before the magnet moves to the closest position. When the magnet moves away from the sensor, the magnet must apply less than the minimum specified  $B_{RP}$  to reliably release the sensor.

Magnets are made from various ferromagnetic materials that have trade-offs in cost, drift with temperature, absolute max temperature ratings, remanence or residual induction ( $B_r$ ), and coercivity ( $H_c$ ). The  $B_r$  and the dimensions of a magnet determine the magnetic flux density ( $B$ ) the magnet produces in 3-dimensional space. For simple magnet shapes, such as rectangular blocks and cylinders, there are simple equations that solve  $B$  at a given distance centered with the magnet.

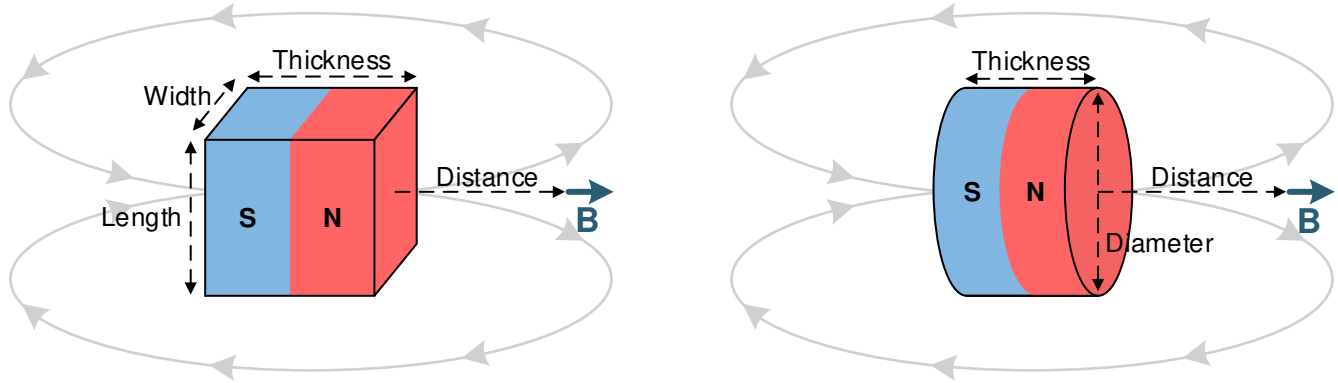

**Figure 8-2. Rectangular Block and Cylinder Magnets**

Use Equation 1 for the rectangular block shown in Figure 8-2:

$$\vec{B} = \frac{B_r}{\pi} \left( \arctan\left(\frac{WL}{2D\sqrt{4D^2 + W^2 + L^2}}\right) - \arctan\left(\frac{WL}{2(D+T)\sqrt{4(D+T)^2 + W^2 + L^2}}\right) \right) \quad (1)$$

Use Equation 2 for the cylinder shown in Figure 8-2:

$$\vec{B} = \frac{B_r}{2} \left( \frac{D+T}{\sqrt{(0.5C)^2 + (D+T)^2}} - \frac{D}{\sqrt{(0.5C)^2 + D^2}} \right) \quad (2)$$

where

- W is width.
- L is length.
- T is thickness (the direction of magnetization).
- D is distance.
- C is diameter.

An online tool that uses these formulas is located at <http://www.ti.com/product/drv5033>.

All magnetic materials generally have a lower  $B_r$  at higher temperatures. Make sure the systems have margin to account for this, as well as for mechanical tolerances.

### 8.2.1.3 Application Curve

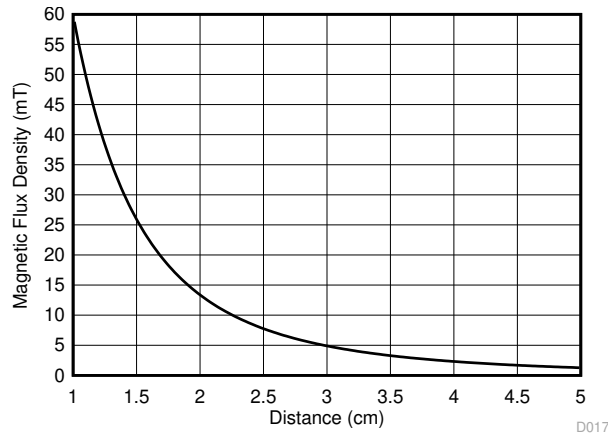

**Figure 8-3. Magnetic Profile of a 1-cm Cube NdFeB Magnet**

### 8.2.2 Three-Position Switch

This application uses the DRV5032FD for a three-position switch.

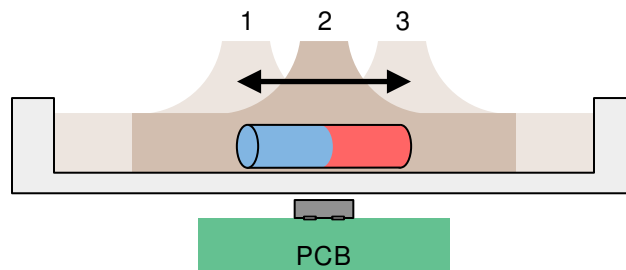

**Figure 8-4. Three-Position Slider Switch With Embedded Magnet**

#### 8.2.2.1 Design Requirements

For this design example, use the parameters listed in [Table 8-2](#).

**Table 8-2. Design Parameters**

DESIGN PARAMETER	EXAMPLE VALUE
Hall effect device	DRV5032FD
V <sub>CC</sub>	5 V
Switch travel distance	5 mm in each direction
Magnet	10-mm cylinder
Mechanical tolerance per position	±0.5 mm

#### 8.2.2.2 Detailed Design Procedure

A standard 2-pole magnet produces strong perpendicular flux components near the outer edges of the poles, and no perpendicular flux near the center at the north-south pole boundary. When the DRV5032FD is below the center of the magnet, the device receives close to 0 mT, and both outputs drive high. If the switch with the embedded magnet moves left or right, the sensor receives a north or south field, and OUT1 or OUT2 drive low. This provides 3 digital states of detection.

The length of the magnet should ideally be two times the distance of travel toward each side. Then, when the switch is pushed to either side, the outer edge of the magnet is positioned directly above the sensor where the magnet applies the strongest perpendicular flux component.

To determine the magnitude of magnetic flux density for a given magnet and distance, TI recommends to either use simulation software, test with a linear Hall effect sensor, or test with a gaussmeter.

### 8.2.2.3 Application Curve

Figure 8-5 shows the typical magnetic flux lines around a 2-pole magnet.

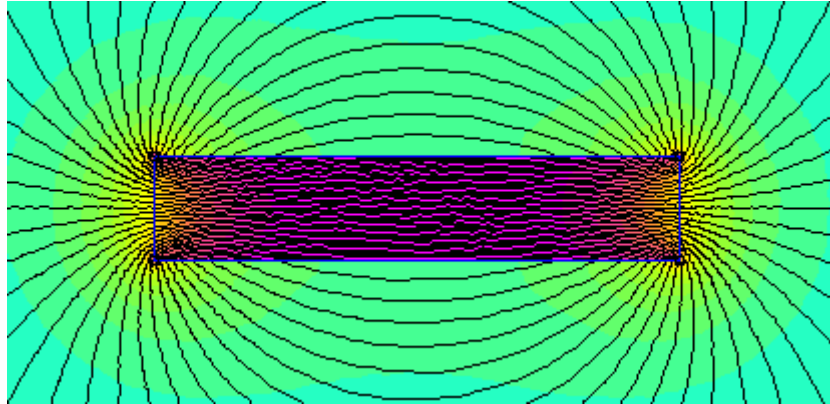

**Figure 8-5. Typical Magnetic Flux Lines**

### 8.3 Best Design Practices

The Hall element is sensitive to magnetic fields that are perpendicular to the top of the package, therefore a correct magnet approach must be used for the sensor to detect the field. [Figure 8-6](#) shows correct and incorrect approaches.

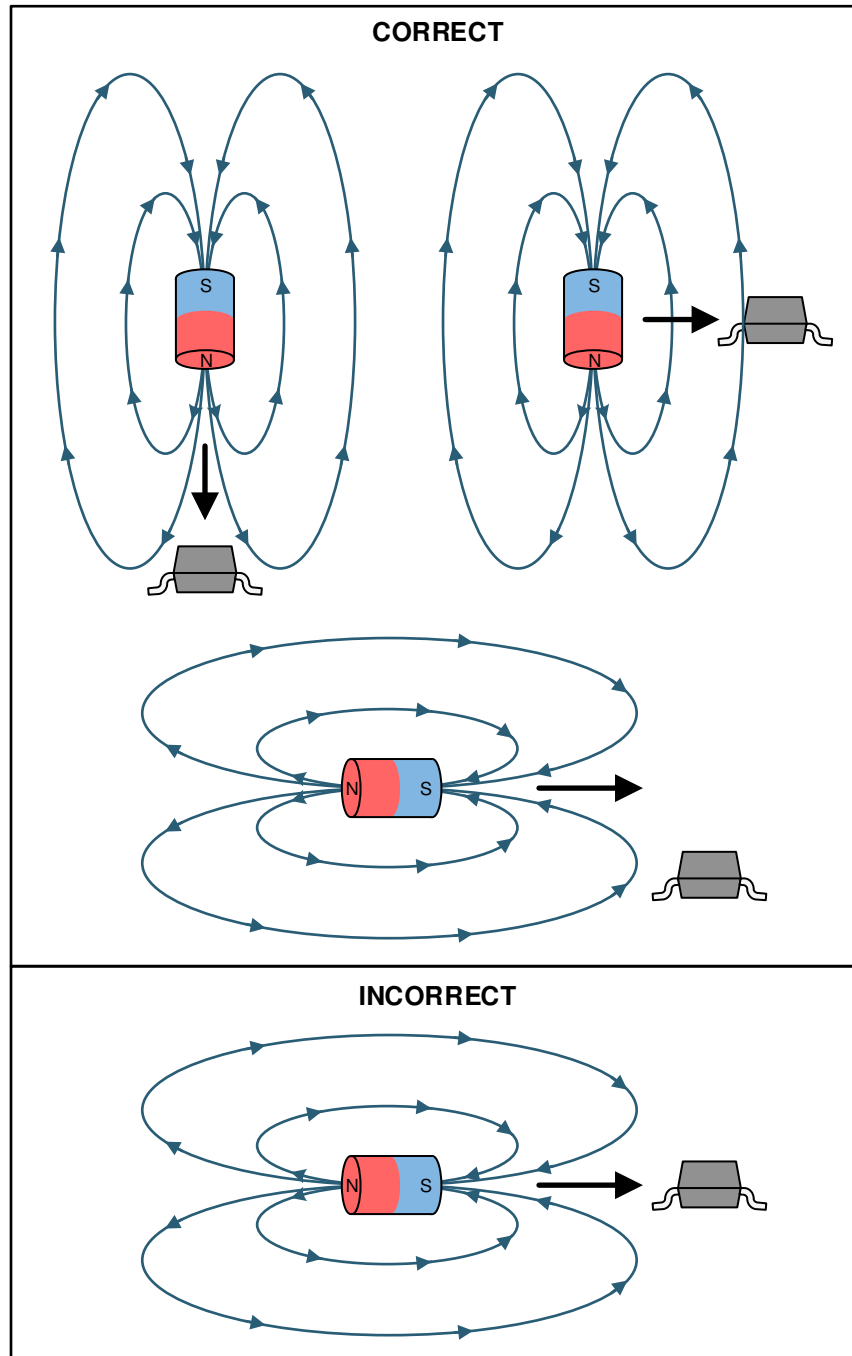

**Figure 8-6. Correct and Incorrect Magnet Approaches**

## 8.4 Power Supply Recommendations

The DRV5032 device is powered from 1.65-V to 5.5-V DC power supplies. A decoupling capacitor close to the device must be used to provide local energy with minimal inductance. TI recommends using a ceramic capacitor with a value of at least 0.1  $\mu\text{F}$ .

## 8.5 Layout

### 8.5.1 Layout Guidelines

Magnetic fields pass through most nonferromagnetic materials with no significant disturbance. It is common practice to embed Hall effect sensors within plastic or aluminum enclosures and sensing magnets on the outside. Magnetic fields also easily pass through most printed-circuit boards, which makes placing the magnet on the opposite side possible.

### 8.5.2 Layout Examples

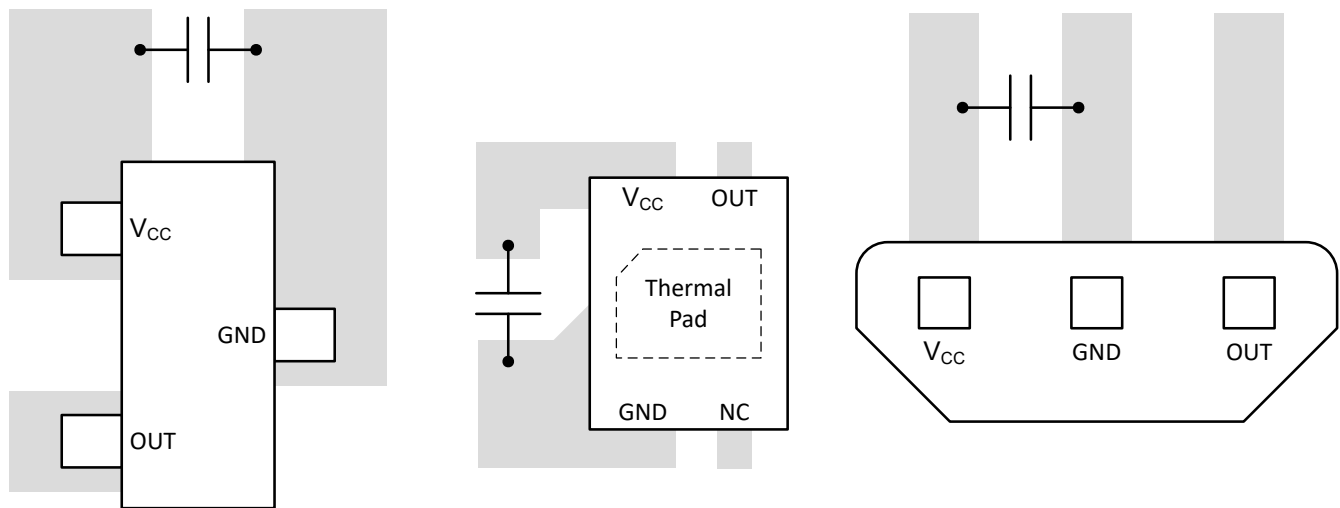

**Figure 8-7. Layout Examples**

## 9 Device and Documentation Support

### 9.1 Documentation Support

#### 9.1.1 Related Documentation

For related documentation see the following:

- Texas Instruments, [DRV5032-SOLAR-EVM user guide](#)
- Texas Instruments, [Power Gating Systems with Magnetic Sensors TI TechNote](#)
- Texas Instruments, [Low-Power Door and Window Sensor With Sub-1GHz and 10-Year Coin Cell Battery Life](#)
- Texas Instruments, [Magnetic Tamper Detection Using Low-Power Hall Effect Sensors](#)
- Texas Instruments, [Fault Monitoring for Overhead Fault Indicators Using Ultra-Low-Power](#)

### 9.2 Receiving Notification of Documentation Updates

To receive notification of documentation updates, navigate to the device product folder on [ti.com](#). Click on *Notifications* to register and receive a weekly digest of any product information that has changed. For change details, review the revision history included in any revised document.

### 9.3 Support Resources

[TI E2E™ support forums](#) are an engineer's go-to source for fast, verified answers and design help — straight from the experts. Search existing answers or ask your own question to get the quick design help you need.

Linked content is provided "AS IS" by the respective contributors. They do not constitute TI specifications and do not necessarily reflect TI's views; see TI's [Terms of Use](#).

### 9.4 Trademarks

TI E2E™ is a trademark of Texas Instruments.

All trademarks are the property of their respective owners.

### 9.5 Electrostatic Discharge Caution



This integrated circuit can be damaged by ESD. Texas Instruments recommends that all integrated circuits be handled with appropriate precautions. Failure to observe proper handling and installation procedures can cause damage.

ESD damage can range from subtle performance degradation to complete device failure. Precision integrated circuits may be more susceptible to damage because very small parametric changes could cause the device not to meet its published specifications.

### 9.6 Glossary

[TI Glossary](#) This glossary lists and explains terms, acronyms, and definitions.

## 10 Revision History

NOTE: Page numbers for previous revisions may differ from page numbers in the current version.

<b>Changes from Revision F (February 2022) to Revision G (July 2024)</b>	<b>Page</b>
• Added DG device version to the DMR (X2SON) package.....	1
• Added preview FB device version information for the DMR (X2SON) package.....	1
• Changed <i>Device Information</i> table to <i>Package Information</i> .....	1
• Changed the X2SON package in the layout examples image to match the pinout image in the <i>Pin Configuration and Functions</i> section.....	21

<b>Changes from Revision E (January 2020) to Revision F (February 2022)</b>	<b>Page</b>
• Updated the numbering format for tables, figures, and cross-references throughout the document.....	1

---

<b>Changes from Revision D (November 2017) to Revision E (January 2020)</b>	<b>Page</b>
• Added LPG (TO-92) package .....	1
• Added notes for the DU and FD package magnetic threshold operate points in the Magnetic Characteristics table.....	6
• Added probability density function plots for B <sub>OP</sub> , B <sub>RP</sub> , and B <sub>HYS</sub> to the <i>Typical Characteristics</i> section.....	7

---

<b>Changes from Revision C (September 2017) to Revision D (November 2017)</b>	<b>Page</b>
• Added the DU device version to the data sheet .....	2

---

<b>Changes from Revision B (August 2017) to Revision C (September 2017)</b>	<b>Page</b>
• Changed the status of the AJ device version from <i>Preview</i> to <i>Active</i> .....	2

---

<b>Changes from Revision A (May 2017) to Revision B (August 2017)</b>	<b>Page</b>
• Added the ZE device version and the preview AJ device version.....	2

---

<b>Changes from Revision * (April 2017) to Revision A (May 2017)</b>	<b>Page</b>
• Added the FA and FD device versions.....	1

---

## 11 Mechanical, Packaging, and Orderable Information

The following pages include mechanical, packaging, and orderable information. This information is the most current data available for the designated devices. This data is subject to change without notice and revision of this document. For browser-based versions of this data sheet, refer to the left-hand navigation.

**PACKAGING INFORMATION**

Orderable Device	Status (1)	Package Type	Package Drawing	Pins	Package Qty	Eco Plan (2)	Lead finish/ Ball material (6)	MSL Peak Temp (3)	Op Temp (°C)	Device Marking (4/5)	Samples
DRV5032AJDBZR	ACTIVE	SOT-23	DBZ	3	3000	RoHS & Green	SN	Level-1-260C-UNLIM	-40 to 85	(1M6W, 2AJ)	<a href="#">Samples</a>
DRV5032AJDMRR	ACTIVE	X2SON	DMR	4	3000	RoHS & Green	SN	Level-1-260C-UNLIM	-40 to 85	2AJ	<a href="#">Samples</a>
DRV5032AJLPG	ACTIVE	TO-92	LPG	3	1000	RoHS & Green	SN	N / A for Pkg Type	-40 to 85	32AJ	<a href="#">Samples</a>
DRV5032AJLPGM	ACTIVE	TO-92	LPG	3	3000	RoHS & Green	SN	N / A for Pkg Type	-40 to 85	32AJ	<a href="#">Samples</a>
DRV5032DGDMMR	ACTIVE	X2SON	DMR	4	3000	RoHS & Green	SN	Level-1-260C-UNLIM	-40 to 85	2DG	<a href="#">Samples</a>
DRV5032DUDBZR	ACTIVE	SOT-23	DBZ	3	3000	RoHS & Green	SN	Level-1-260C-UNLIM	-40 to 85	2DU	<a href="#">Samples</a>
DRV5032DUDMRR	ACTIVE	X2SON	DMR	4	3000	RoHS & Green	SN	Level-1-260C-UNLIM	-40 to 85	2DU	<a href="#">Samples</a>
DRV5032DULPG	ACTIVE	TO-92	LPG	3	1000	RoHS & Green	SN	N / A for Pkg Type	-40 to 85	32DU	<a href="#">Samples</a>
DRV5032DULPGM	ACTIVE	TO-92	LPG	3	3000	RoHS & Green	SN	N / A for Pkg Type	-40 to 85	32DU	<a href="#">Samples</a>
DRV5032FADBZR	ACTIVE	SOT-23	DBZ	3	3000	RoHS & Green	SN	Level-1-260C-UNLIM	-40 to 85	(1LVW, 2FA)	<a href="#">Samples</a>
DRV5032FADMRR	ACTIVE	X2SON	DMR	4	3000	RoHS & Green	SN	Level-1-260C-UNLIM	-40 to 85	2FA	<a href="#">Samples</a>
DRV5032FALPG	ACTIVE	TO-92	LPG	3	1000	RoHS & Green	SN	N / A for Pkg Type	-40 to 85	32FA	<a href="#">Samples</a>
DRV5032FALPGM	ACTIVE	TO-92	LPG	3	3000	RoHS & Green	SN	N / A for Pkg Type	-40 to 85	32FA	<a href="#">Samples</a>
DRV5032FBDBZR	ACTIVE	SOT-23	DBZ	3	3000	RoHS & Green	SN	Level-1-260C-UNLIM	-40 to 85	(1LWW, 2FB)	<a href="#">Samples</a>
DRV5032FBLPG	ACTIVE	TO-92	LPG	3	1000	RoHS & Green	SN	N / A for Pkg Type	-40 to 85	32FB	<a href="#">Samples</a>
DRV5032FBLPGM	ACTIVE	TO-92	LPG	3	3000	RoHS & Green	SN	N / A for Pkg Type	-40 to 85	32FB	<a href="#">Samples</a>
DRV5032FCDBZR	ACTIVE	SOT-23	DBZ	3	3000	RoHS & Green	SN	Level-1-260C-UNLIM	-40 to 85	(1M7W, 2FC)	<a href="#">Samples</a>
DRV5032FCLPG	ACTIVE	TO-92	LPG	3	1000	RoHS & Green	SN	N / A for Pkg Type	-40 to 85	32FC	<a href="#">Samples</a>
DRV5032FCLPGM	ACTIVE	TO-92	LPG	3	3000	RoHS & Green	SN	N / A for Pkg Type	-40 to 85	32FC	<a href="#">Samples</a>
DRV5032FDDMRR	ACTIVE	X2SON	DMR	4	3000	RoHS & Green	SN	Level-1-260C-UNLIM	-40 to 85	2FD	<a href="#">Samples</a>



Orderable Device	Status (1)	Package Type	Package Drawing	Pins	Package Qty	Eco Plan (2)	Lead finish/ Ball material (6)	MSL Peak Temp (3)	Op Temp (°C)	Device Marking (4/5)	Samples
DRV5032FDLPG	ACTIVE	TO-92	LPG	3	1000	RoHS & Green	SN	N / A for Pkg Type	-40 to 85	32FD	<a href="#">Samples</a>
DRV5032FDLPGM	ACTIVE	TO-92	LPG	3	3000	RoHS & Green	SN	N / A for Pkg Type	-40 to 85	32FD	<a href="#">Samples</a>
DRV5032ZEDBZR	ACTIVE	SOT-23	DBZ	3	3000	RoHS & Green	SN	Level-1-260C-UNLIM	-40 to 85	(1M8W, 2ZE)	<a href="#">Samples</a>
DRV5032ZELPG	ACTIVE	TO-92	LPG	3	1000	RoHS & Green	SN	N / A for Pkg Type	-40 to 85	32ZE	<a href="#">Samples</a>
DRV5032ZELPGM	ACTIVE	TO-92	LPG	3	3000	RoHS & Green	SN	N / A for Pkg Type	-40 to 85	32ZE	<a href="#">Samples</a>

(1) The marketing status values are defined as follows:

**ACTIVE:** Product device recommended for new designs.

**LIFEBUY:** TI has announced that the device will be discontinued, and a lifetime-buy period is in effect.

**NRND:** Not recommended for new designs. Device is in production to support existing customers, but TI does not recommend using this part in a new design.

**PREVIEW:** Device has been announced but is not in production. Samples may or may not be available.

**OBSOLETE:** TI has discontinued the production of the device.

(2) **RoHS:** TI defines "RoHS" to mean semiconductor products that are compliant with the current EU RoHS requirements for all 10 RoHS substances, including the requirement that RoHS substance do not exceed 0.1% by weight in homogeneous materials. Where designed to be soldered at high temperatures, "RoHS" products are suitable for use in specified lead-free processes. TI may reference these types of products as "Pb-Free".

**RoHS Exempt:** TI defines "RoHS Exempt" to mean products that contain lead but are compliant with EU RoHS pursuant to a specific EU RoHS exemption.

**Green:** TI defines "Green" to mean the content of Chlorine (Cl) and Bromine (Br) based flame retardants meet JS709B low halogen requirements of <=1000ppm threshold. Antimony trioxide based flame retardants must also meet the <=1000ppm threshold requirement.

(3) MSL, Peak Temp. - The Moisture Sensitivity Level rating according to the JEDEC industry standard classifications, and peak solder temperature.

(4) There may be additional marking, which relates to the logo, the lot trace code information, or the environmental category on the device.

(5) Multiple Device Markings will be inside parentheses. Only one Device Marking contained in parentheses and separated by a "~" will appear on a device. If a line is indented then it is a continuation of the previous line and the two combined represent the entire Device Marking for that device.

(6) Lead finish/Ball material - Orderable Devices may have multiple material finish options. Finish options are separated by a vertical ruled line. Lead finish/Ball material values may wrap to two lines if the finish value exceeds the maximum column width.

**Important Information and Disclaimer:**The information provided on this page represents TI's knowledge and belief as of the date that it is provided. TI bases its knowledge and belief on information provided by third parties, and makes no representation or warranty as to the accuracy of such information. Efforts are underway to better integrate information from third parties. TI has taken and

continues to take reasonable steps to provide representative and accurate information but may not have conducted destructive testing or chemical analysis on incoming materials and chemicals. TI and TI suppliers consider certain information to be proprietary, and thus CAS numbers and other limited information may not be available for release.

In no event shall TI's liability arising out of such information exceed the total purchase price of the TI part(s) at issue in this document sold by TI to Customer on an annual basis.

**TAPE AND REEL INFORMATION**

**QUADRANT ASSIGNMENTS FOR PIN 1 ORIENTATION IN TAPE**

\*All dimensions are nominal

Device	Package Type	Package Drawing	Pins	SPQ	Reel Diameter (mm)	Reel Width W1 (mm)	A0 (mm)	B0 (mm)	K0 (mm)	P1 (mm)	W (mm)	Pin1 Quadrant
DRV5032AJDBZR	SOT-23	DBZ	3	3000	180.0	8.4	3.2	2.85	1.3	4.0	8.0	Q3
DRV5032AJDMRR	X2SON	DMR	4	3000	179.0	8.4	1.27	1.57	0.5	4.0	8.0	Q1
DRV5032DUDBZR	SOT-23	DBZ	3	3000	180.0	8.4	3.15	2.77	1.22	4.0	8.0	Q3
DRV5032DUDMRR	X2SON	DMR	4	3000	180.0	8.4	1.27	1.57	0.5	4.0	8.0	Q1
DRV5032FADBZR	SOT-23	DBZ	3	3000	180.0	8.4	3.2	2.85	1.3	4.0	8.0	Q3
DRV5032FADMRR	X2SON	DMR	4	3000	179.0	8.4	1.27	1.57	0.5	4.0	8.0	Q1
DRV5032FBDBZR	SOT-23	DBZ	3	3000	180.0	8.4	3.2	2.85	1.3	4.0	8.0	Q3
DRV5032FCDBZR	SOT-23	DBZ	3	3000	180.0	8.4	3.2	2.85	1.3	4.0	8.0	Q3
DRV5032FDDMRR	X2SON	DMR	4	3000	179.0	8.4	1.27	1.57	0.5	4.0	8.0	Q1
DRV5032ZEDBZR	SOT-23	DBZ	3	3000	180.0	8.4	3.2	2.85	1.3	4.0	8.0	Q3

**TAPE AND REEL BOX DIMENSIONS**

\*All dimensions are nominal

Device	Package Type	Package Drawing	Pins	SPQ	Length (mm)	Width (mm)	Height (mm)
DRV5032AJDBZR	SOT-23	DBZ	3	3000	210.0	185.0	35.0
DRV5032AJDMRR	X2SON	DMR	4	3000	200.0	183.0	25.0
DRV5032DUDBZR	SOT-23	DBZ	3	3000	183.0	183.0	20.0
DRV5032DUDMRR	X2SON	DMR	4	3000	200.0	183.0	25.0
DRV5032FADBZR	SOT-23	DBZ	3	3000	210.0	185.0	35.0
DRV5032FADMRR	X2SON	DMR	4	3000	200.0	183.0	25.0
DRV5032FBDBZR	SOT-23	DBZ	3	3000	210.0	185.0	35.0
DRV5032FCDBZR	SOT-23	DBZ	3	3000	210.0	185.0	35.0
DRV5032FDDMRR	X2SON	DMR	4	3000	200.0	183.0	25.0
DRV5032ZEDBZR	SOT-23	DBZ	3	3000	210.0	185.0	35.0

# LPG0003A



# PACKAGE OUTLINE

## TO-92 - 5.05 mm max height

TRANSISTOR OUTLINE

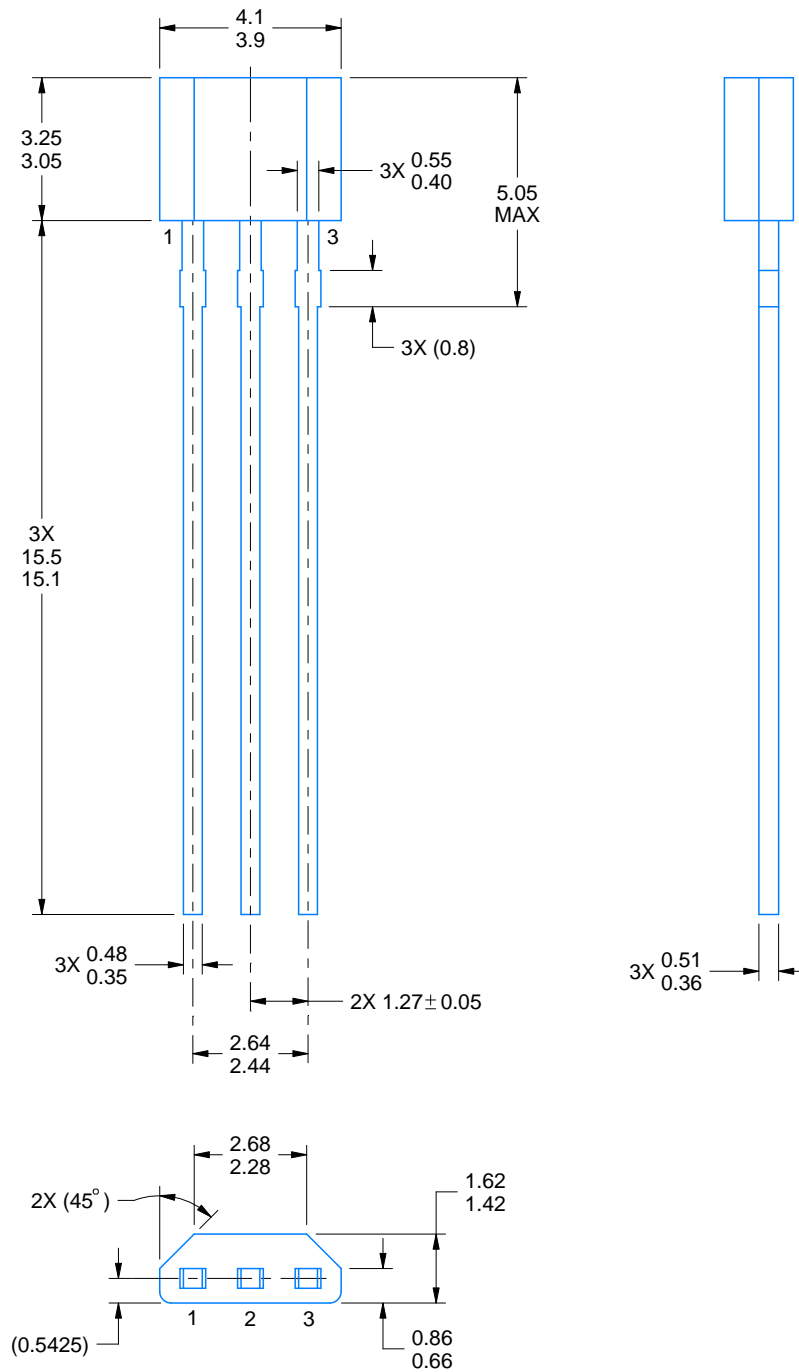

4221343/C 01/2018

### NOTES:

1. All linear dimensions are in millimeters. Any dimensions in parenthesis are for reference only. Dimensioning and tolerancing per ASME Y14.5M.
2. This drawing is subject to change without notice.

# EXAMPLE BOARD LAYOUT

LPG0003A

TO-92 - 5.05 mm max height

TRANSISTOR OUTLINE

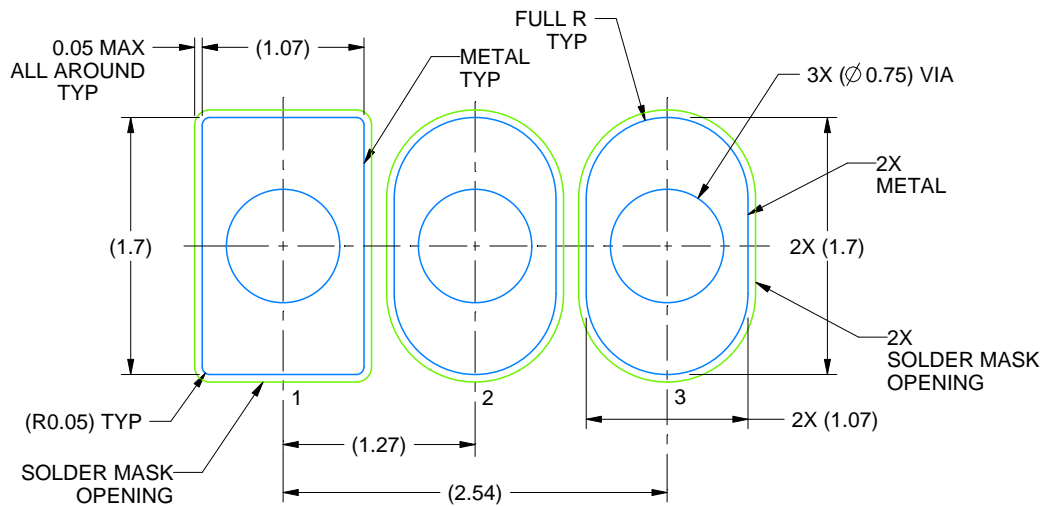

LAND PATTERN EXAMPLE  
NON-SOLDER MASK DEFINED  
SCALE:20X

4221343/C 01/2018

# TAPE SPECIFICATIONS

LPG0003A

TO-92 - 5.05 mm max height

TRANSISTOR OUTLINE

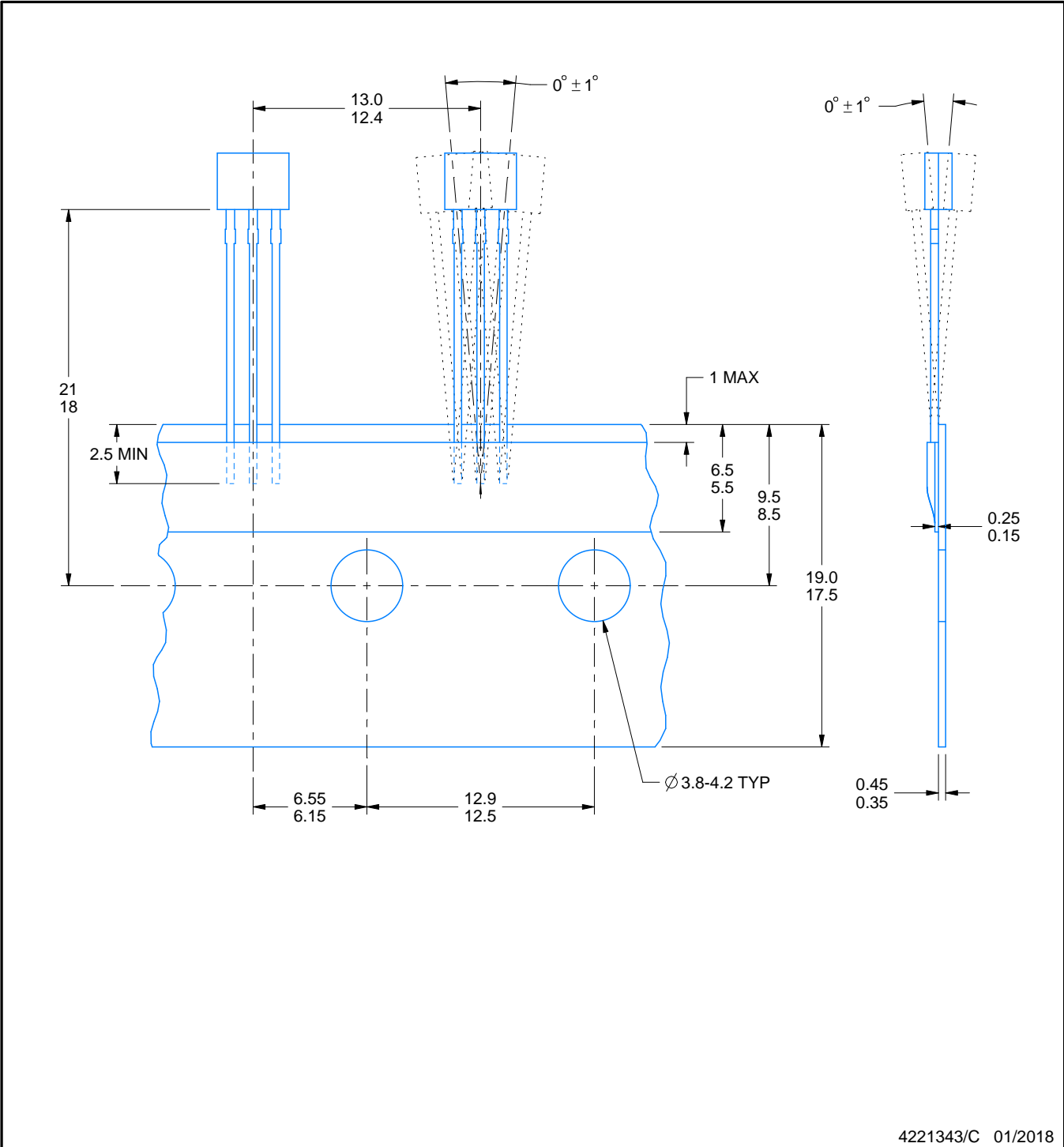

4221343/C 01/2018

## GENERIC PACKAGE VIEW

**DMR 4**

**X2SON - 0.4 mm max height**

1.1 x 1.4, 0.5 mm pitch

PLASTIC SMALL OUTLINE - NO LEAD

This image is a representation of the package family, actual package may vary.  
Refer to the product data sheet for package details.



4229480/A



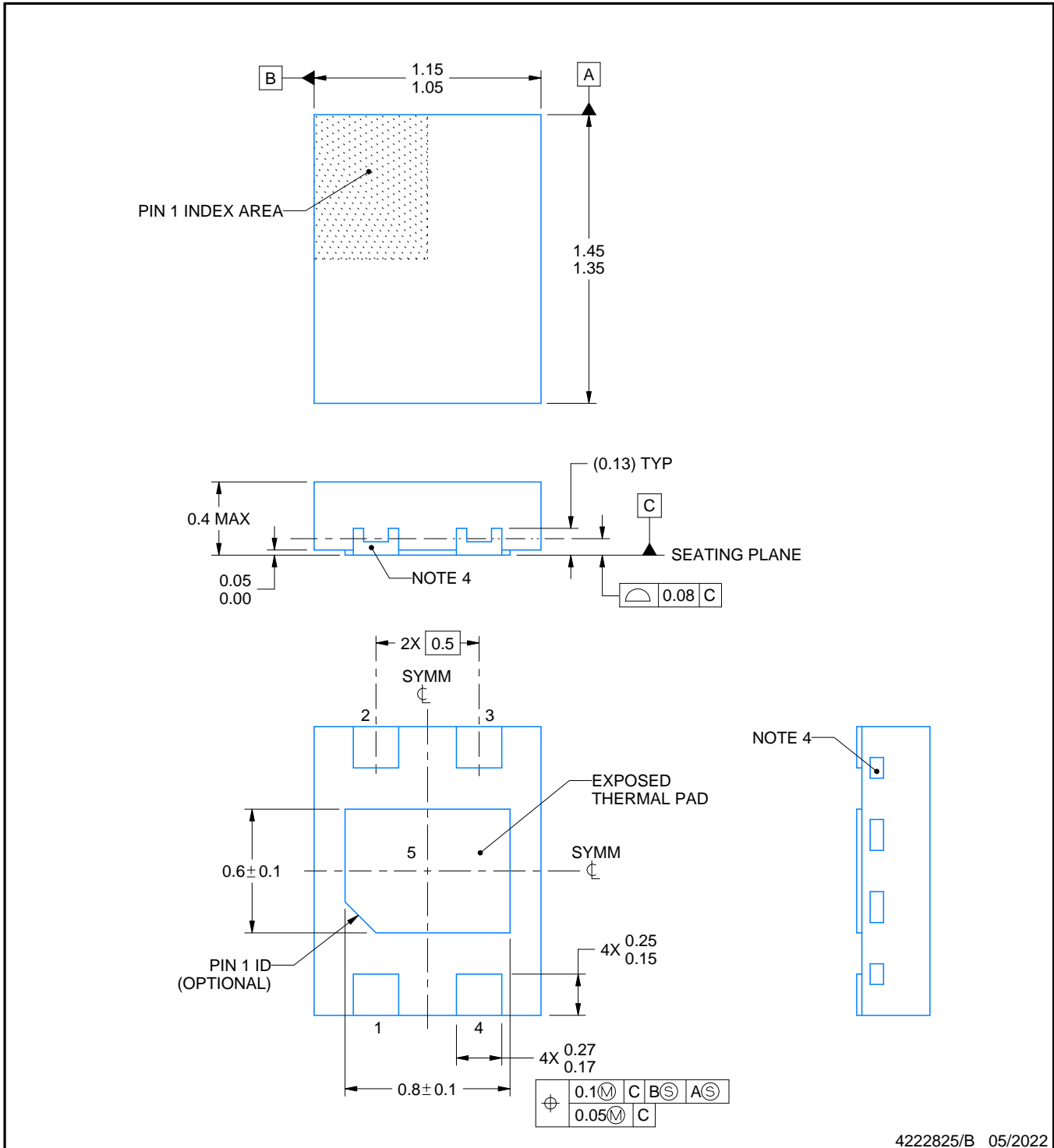
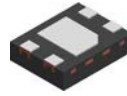

4222825/B 05/2022

NOTES:

1. All linear dimensions are in millimeters. Any dimensions in parenthesis are for reference only. Dimensioning and tolerancing per ASME Y14.5M.
2. This drawing is subject to change without notice.
3. The package thermal pad must be soldered to the printed circuit board for thermal and mechanical performance.
4. Quantity and shape of side wall metal may vary.

# EXAMPLE BOARD LAYOUT

DMR0004A

X2SON - 0.4 mm max height

PLASTIC SMALL OUTLINE - NO LEAD

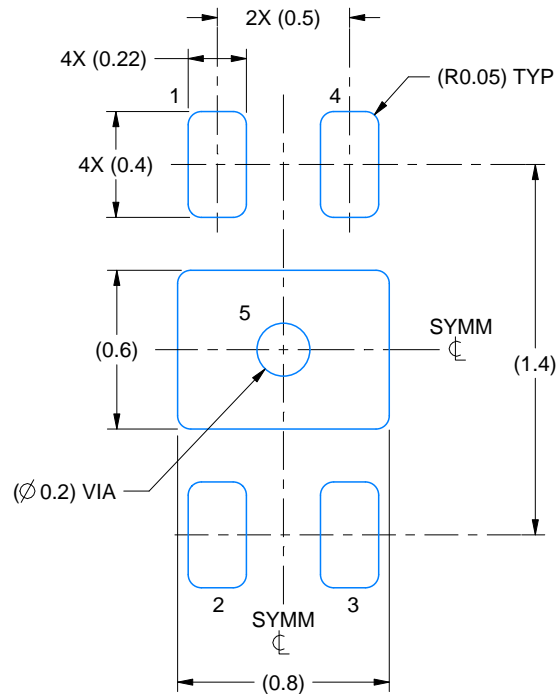

LAND PATTERN EXAMPLE  
SCALE:35X

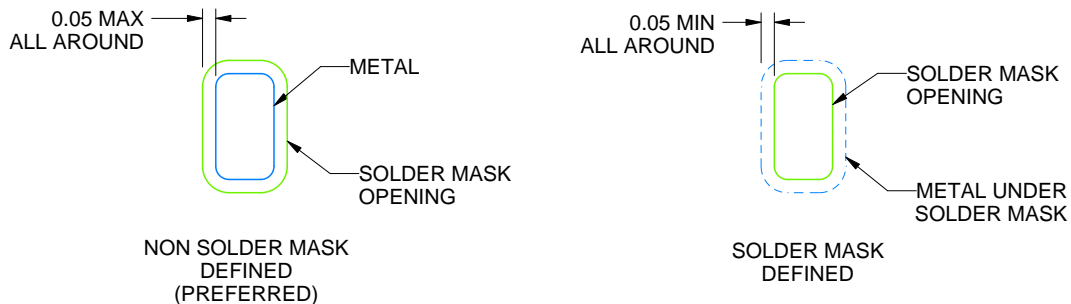

SOLDER MASK DETAILS

4222825/B 05/2022

NOTES: (continued)

5. This package is designed to be soldered to a thermal pad on the board. For more information, see Texas Instruments literature number SLUA271 ([www.ti.com/lit/slua271](http://www.ti.com/lit/slua271)).
6. Vias are optional depending on application, refer to device data sheet. If all or some are implemented, recommended via locations are shown. It is recommended that vias under paste be filled, plugged or tented.

# EXAMPLE STENCIL DESIGN

DMR0004A

X2SON - 0.4 mm max height

PLASTIC SMALL OUTLINE - NO LEAD

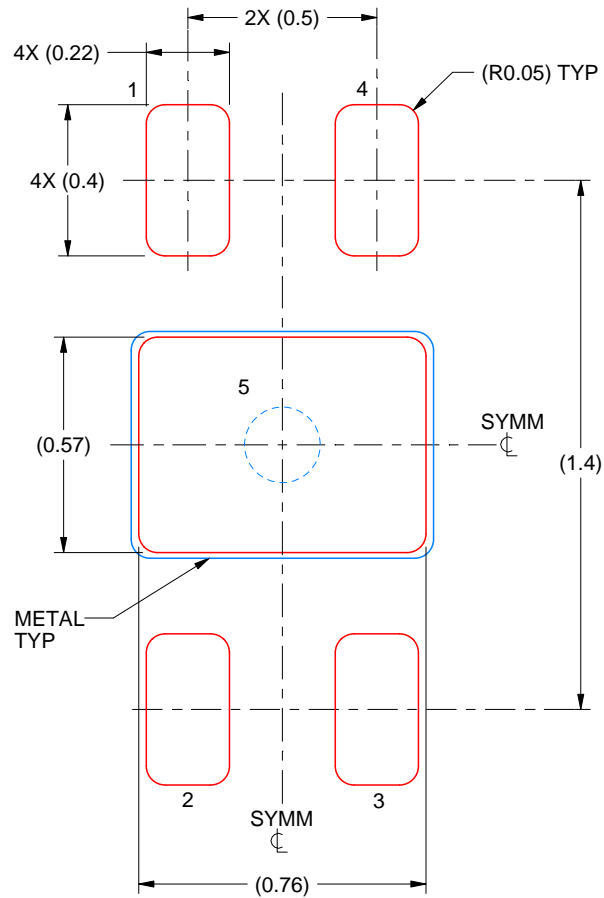

SOLDER PASTE EXAMPLE  
BASED ON 0.1 mm THICK STENCIL

EXPOSED PAD 5:  
90% PRINTED SOLDER COVERAGE BY AREA  
SCALE:50X

4222825/B 05/2022

NOTES: (continued)

7. Laser cutting apertures with trapezoidal walls and rounded corners may offer better paste release. IPC-7525 may have alternate design recommendations.

# DBZ0003A

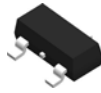

# PACKAGE OUTLINE

SOT-23 - 1.12 mm max height

SMALL OUTLINE TRANSISTOR

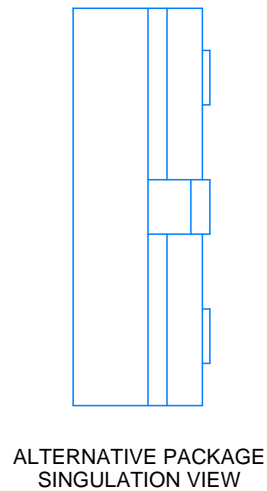
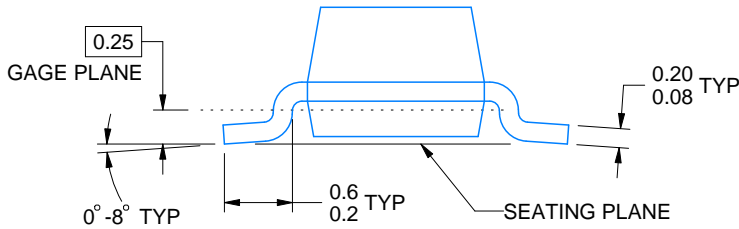
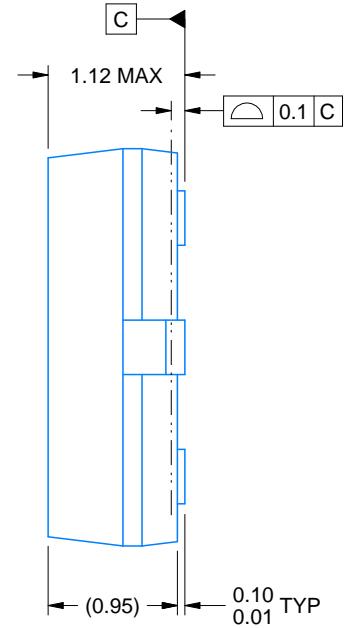
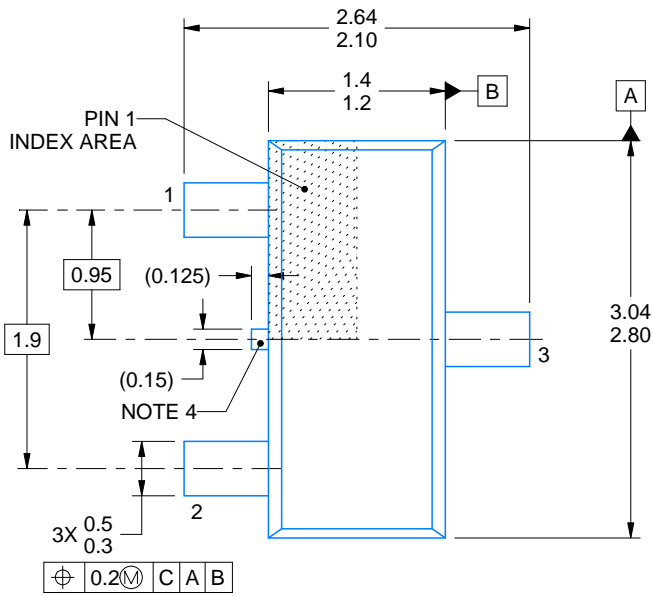

4214838/E 06/2024

## NOTES:

- All linear dimensions are in millimeters. Any dimensions in parenthesis are for reference only. Dimensioning and tolerancing per ASME Y14.5M.
- This drawing is subject to change without notice.
- Reference JEDEC registration TO-236, except minimum foot length.
- Support pin may differ or may not be present.
- Body dimensions do not include mold flash, protrusions, or gate burrs. Mold flash, protrusions, or gate burrs shall not exceed 0.25mm per side

# EXAMPLE BOARD LAYOUT

DBZ0003A

SOT-23 - 1.12 mm max height

SMALL OUTLINE TRANSISTOR

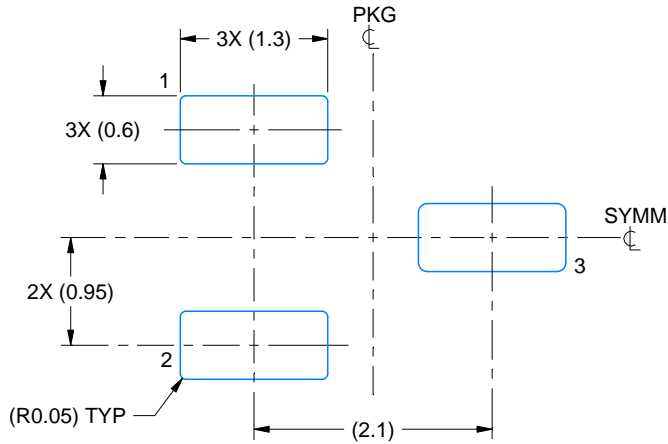

LAND PATTERN EXAMPLE  
SCALE:15X

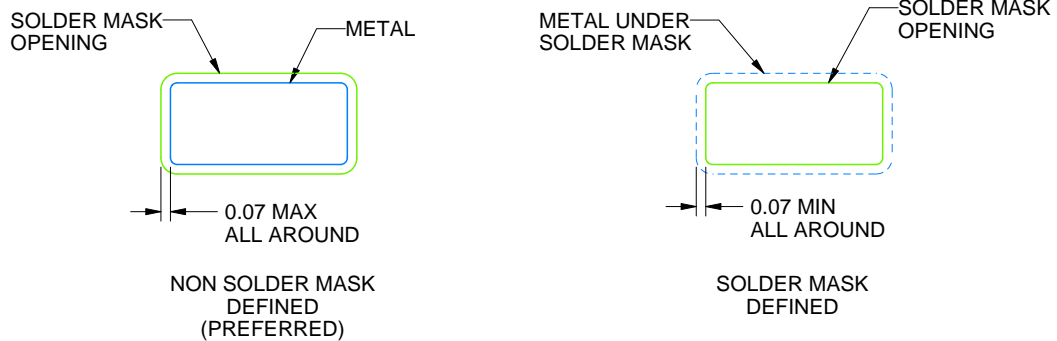

SOLDER MASK DETAILS

4214838/E 06/2024

NOTES: (continued)

- 5. Publication IPC-7351 may have alternate designs.
- 6. Solder mask tolerances between and around signal pads can vary based on board fabrication site.

# EXAMPLE STENCIL DESIGN

DBZ0003A

SOT-23 - 1.12 mm max height

SMALL OUTLINE TRANSISTOR

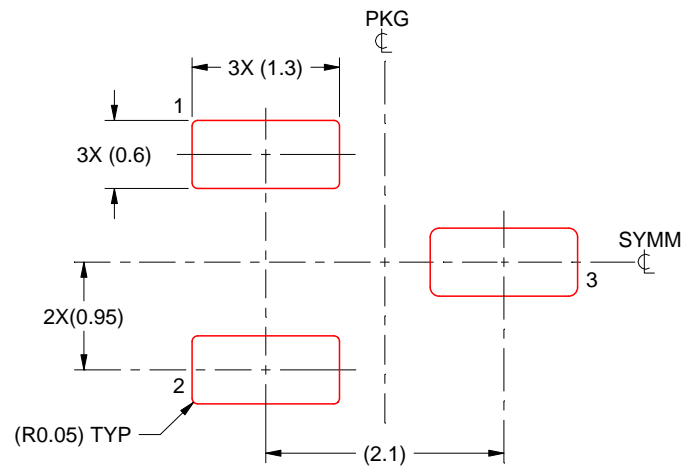

SOLDER PASTE EXAMPLE  
BASED ON 0.125 THICK STENCIL  
SCALE:15X

4214838/E 06/2024

NOTES: (continued)

7. Laser cutting apertures with trapezoidal walls and rounded corners may offer better paste release. IPC-7525 may have alternate design recommendations.
8. Board assembly site may have different recommendations for stencil design.

## IMPORTANT NOTICE AND DISCLAIMER

TI PROVIDES TECHNICAL AND RELIABILITY DATA (INCLUDING DATA SHEETS), DESIGN RESOURCES (INCLUDING REFERENCE DESIGNS), APPLICATION OR OTHER DESIGN ADVICE, WEB TOOLS, SAFETY INFORMATION, AND OTHER RESOURCES "AS IS" AND WITH ALL FAULTS, AND DISCLAIMS ALL WARRANTIES, EXPRESS AND IMPLIED, INCLUDING WITHOUT LIMITATION ANY IMPLIED WARRANTIES OF MERCHANTABILITY, FITNESS FOR A PARTICULAR PURPOSE OR NON-INFRINGEMENT OF THIRD PARTY INTELLECTUAL PROPERTY RIGHTS.

These resources are intended for skilled developers designing with TI products. You are solely responsible for (1) selecting the appropriate TI products for your application, (2) designing, validating and testing your application, and (3) ensuring your application meets applicable standards, and any other safety, security, regulatory or other requirements.

These resources are subject to change without notice. TI grants you permission to use these resources only for development of an application that uses the TI products described in the resource. Other reproduction and display of these resources is prohibited. No license is granted to any other TI intellectual property right or to any third party intellectual property right. TI disclaims responsibility for, and you will fully indemnify TI and its representatives against, any claims, damages, costs, losses, and liabilities arising out of your use of these resources.

TI's products are provided subject to [TI's Terms of Sale](#) or other applicable terms available either on [ti.com](https://www.ti.com) or provided in conjunction with such TI products. TI's provision of these resources does not expand or otherwise alter TI's applicable warranties or warranty disclaimers for TI products.

TI objects to and rejects any additional or different terms you may have proposed.

Mailing Address: Texas Instruments, Post Office Box 655303, Dallas, Texas 75265  
Copyright © 2024, Texas Instruments Incorporated