

FEATURES

- Halts and restarts an out-of-control μ -processor
- Holds μ -processor in check during power transients
- Automatically restarts μ -processor after power failure
- Monitors push-button for external override
- Accurate 5% or 10% μ -processor power supply monitoring
- Eliminates the need for discrete components

APPLICATIONS

- μ -processor Power Monitoring
- Intelligent Instruments
- Computers and Controllers
- Automotive Systems

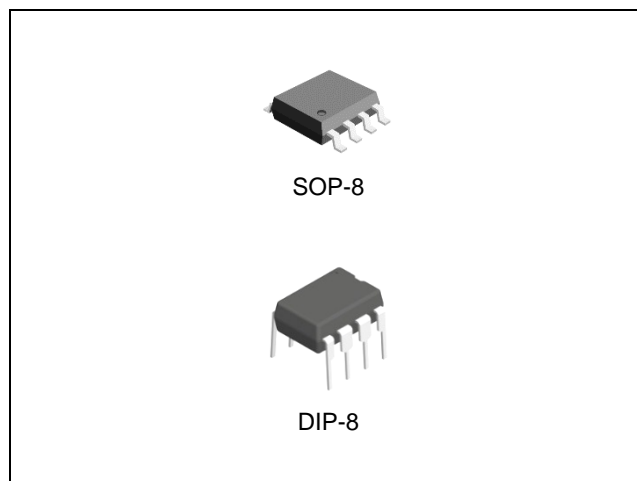

ORDERING INFORMATION

Device	Package
DS1232D	SOP-8
DS1232N	DIP-8

DESCRIPTION

The DS1232 Micro-Monitor monitors three vital conditions for a microprocessor: power supply, software execution, and external override. First, a precision temperature compensated reference and comparator circuit monitors the status of VCC. When an out-of-tolerance condition occurs, an internal power fail signal is generated which forces reset to the active state. When VCC returns to an in-tolerance condition, the reset signals are kept in the active state for a minimum of 250ms to allow the power supply and processor to stabilize. The second function the DS1232 performs is pushbutton reset control. The DS1232 debounces the pushbutton input and guarantees an active reset pulse width of 250ms minimum. The third function is a watchdog timer. The DS1232 has an internal timer that forces the reset signals to the active state if the strobe input is not driven low prior to time-out. The watchdog timer function can be set to operate on time-out settings of approximately 150ms, 600ms, and 1.2 seconds.

ABSOLUTE MAXIMUM RATINGS

CHARACTERISTIC	SYMBOL	MIN.	MAX.	UNIT
Supply Voltage	V_{CC}	-0.5	7.0	V
Input / Output Voltage	\overline{PBRST} , TD, TOL, \overline{RST} , RST, \overline{ST}	-0.5	$V_{CC}+0.5$	V
Operating Ambient Temperature Range	T_A	-10	70	$^{\circ}C$
Storage Temperature	T_{STG}	-55	125	$^{\circ}C$

RECOMMENDED OPERATING CONDITIONS

CHARACTERISTIC	SYMBOL	MIN.	MAX.	UNIT
Supply Voltage	V _{CC}	4.5	5.5	V
\overline{ST} and \overline{PBRST} Input High Level	V _{IH}	2.0	V _{CC} +0.3	V
\overline{ST} and \overline{PBRST} Input Low Level	V _{IL}	-0.3	0.8	V

ORDERING INFORMATION

Package	Order No.	Description	Supplied As	Status
SOP-8	DS1232D	Micro-Monitor	Reel	Active
DIP-8	DS1232N	Micro-Monitor	Tube	Active

PIN CONFIGURATION

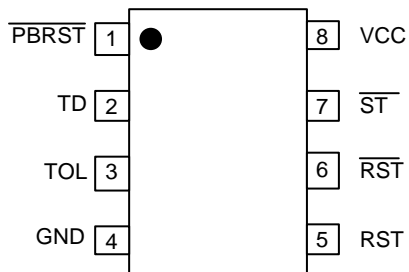

SOP-8 / DIP-8

PIN DESCRIPTION

Pin No.		Pin Name	Pin Function
SOP-8	DIP-8		
1	1	$\overline{\text{PBRST}}$	Pushbutton Reset Input
2	2	TD	Time Delay Set
3	3	TOL	Selects 5% or 10% V_{CC} Detect
4	4	GND	Ground
5	5	RST	Reset Output (Active High)
6	6	$\overline{\text{RST}}$	Reset Output (Active Low, Open Drain)
7	7	$\overline{\text{ST}}$	Strobe Input
8	8	V_{CC}	5V Supply Power

ELECTRICAL CHARACTERISTICS

Specifications with standard type face are for $T_A = 25^\circ\text{C}$, $V_{CC} = 5\text{V}$, and those with **boldface type** are for -10°C to 70°C unless otherwise noted. ^(Note 1)

PARAMETER	SYMBOL	TEST CONDITIONS	MIN	TYP	MAX	UNIT
DC ELECTRICAL CHARACTERISTICS						
Input Leakage	I_{IL}	(Note 3)	-1.0		1.0	μA
Output Current @ 2.4V	I_{OH}	(Note 5)	-8	-10		mA
Output Current @ 0.4V	I_{OL}		8	10		mA
Low Level @ RST	V_{OL}	(Note 1)			0.4	V
Output Voltage @ -500 μA	V_{OH}	(Note 1, 7)	$V_{CC}-0.5$	$V_{CC}-0.1$		V
Operating Current	I_{CC}	(Note 2)		0.5	2.0	mA
V_{CC} Trip Point	V_{CCTP1}	TOL=GND ^(Note 1)	4.50	4.62	4.74	V
V_{CC} Trip Point	V_{CCTP2}	TOL= V_{CC} ^(Note 1)	4.25	4.37	4.49	V
AC ELECTRICAL CHARACTERISTICS						
$\overline{\text{PBRST}} = V_{IL}$	t_{PB}		20			ms
RESET Active Time	t_{RST}		250	610	1000	ms
$\overline{\text{ST}}$ Pulse Width	t_{ST}	(Note 6, 8)	20			ns
V_{CC} Fail Detect to RST and $\overline{\text{RST}}$	t_{RPD}			100	175	μs
V_{CC} Slew Rate 4.75V to 4.25V	t_F		300			μs
V_{CC} Detect to RST and $\overline{\text{RST}}$ Transition	t_{RPU}	(Note 4)	250	610	1000	ms
V_{CC} Slew Rate 4.25V to 4.75V	t_R		0	5		μs
$\overline{\text{PBRST}}$ Stable Low to RST and $\overline{\text{RST}}$	t_{PDLY}				20	ms
CAPACITANCE						
Input Capacitance	C_{IN}				5	pF
Output Capacitance	C_{OUT}				7	pF

Note 1. All voltages referenced to ground.

Note 2. Measured with outputs open.

Note 3. $\overline{\text{PBRST}}$ is internally pulled up to V_{CC} with an internal impedance of 10K typical.

Note 4. $t_R = 5 \mu\text{s}$.

Note 5. $\overline{\text{RST}}$ is an open drain output.

Note 6. Must not exceed t_{TD} minimum. See Table 1.

Note 7. RST remains within 0.5V of V_{CC} on power-down until V_{CC} drops below 2.0V.

$\overline{\text{RST}}$ remains within 0.5V of GND on power-down until V_{CC} drops below 2.0V.

Note 8. Watchdog cannot be disabled. It must be strobed to avoid resets.

TYPICAL APPLICATION INFORMATION

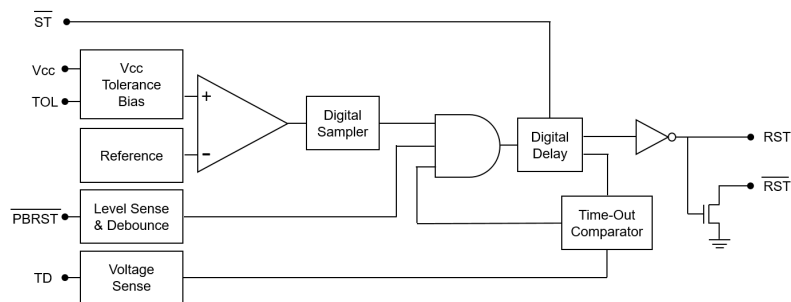

Fig.1. Block Diagram

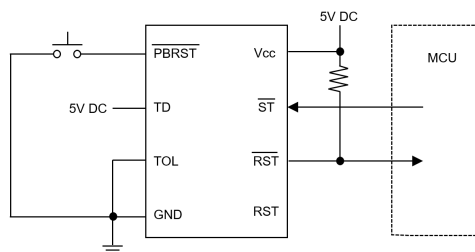

Fig 2. Typical Application

Power Monitor

The DS1232 detects out-of-tolerance power supply conditions and warns a processor-based system of impending power failure. When V_{CC} falls below a preset level as defined by TOL (Pin 3), the V_{CC} comparator outputs the signals RST (Pin 5) and \overline{RST} (Pin 6). When TOL is connected to ground, the RST and \overline{RST} signals become active as V_{CC} falls below 4.75 volts. When TOL is connected to V_{CC} , the RST and \overline{RST} signals become active as V_{CC} falls below 4.5 volts. The RST and \overline{RST} are excellent control signals for a microprocessor, as processing is stopped at the last possible moments of valid V_{CC} . On power-up, RST and \overline{RST} are kept active for a minimum of 250 ms to allow the power supply and processor to stabilize.

Pushbutton Reset

The DS1232 provides an input pin for direct connection to a pushbutton. The pushbutton reset input requires an active low signal. Internally, this input is debounced and timed such that RST and \overline{RST} signals of at least 250 ms minimum are generated. The 250 ms delay starts as the pushbutton reset input is released from low level.

Watchdog Timer

A watchdog timer function forces RST and \overline{RST} signals to the active state when the \overline{ST} input is not stimulated for a predetermined time period. The time period is set by the TD input to be typically 150 ms with TD connected to ground, 600 ms with TD left unconnected, and 1.2 seconds with TD connected to V_{CC} . The watchdog timer starts timing out from the set time period as soon as RST and \overline{RST} are inactive. If a high-to-low transition occurs on the \overline{ST} input pin prior to timeout, the watchdog timer is reset and begins to timeout again. If the watchdog timer is allowed to timeout, then the RST and \overline{RST} signals are driven to the active state for 250 ms minimum. The \overline{ST} input can be derived from microprocessor address signals, data signals, and/or control

signals. When the microprocessor is functioning normally, these signals would, as a matter of routine, cause the watchdog to be reset prior to timeout. To guarantee that the watchdog timer does not timeout, a high-to-low transition must occur at or less than the minimum shown in Table 1.

Timing Diagrams

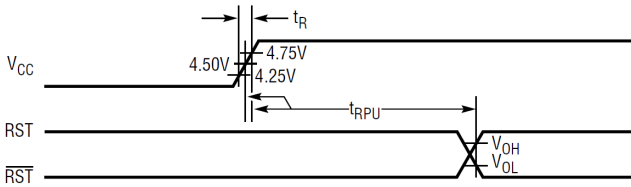

Fig. 3. Power Up Timing Diagram

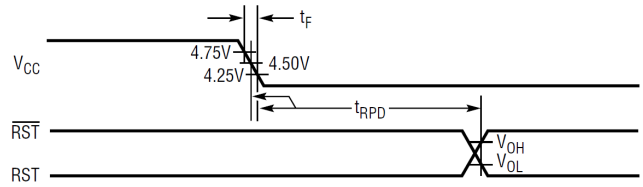

Fig. 4. Power Down Timing Diagram

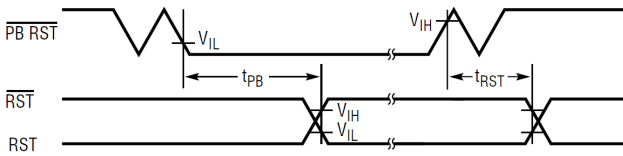

Fig. 5. Pushbutton Reset Timing Diagram

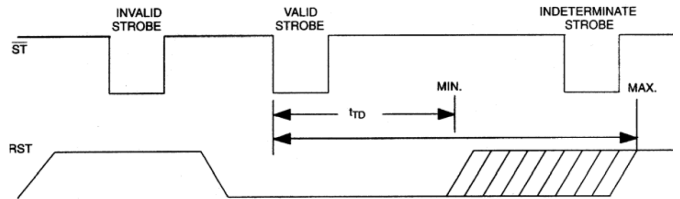

Fig. 6. Strobe Input Timing Diagram

Table 1. Watchdog Timeouts

TD Pin	TIME-OUT		
	Min.	Typ.	Max.
GND	62.5ms	150ms	250ms
Float	250ms	600ms	1000ms
Vcc	500ms	1200ms	2000ms

REVISION NOTICE

The description in this datasheet is subject to change without any notice to describe its electrical characteristics properly.