

DALLAS

SEMICONDUCTOR

DS1688/DS1691

3 Volt/5 Volt Serialized Real Time Clock with NV RAM Control

FEATURES

Incorporates industry standard DS1287 PC clock plus enhanced features:

- +3 or +5 volt operation
- 64-bit Silicon serial number
- 64-bit customer specific ROM or additional serial number available
- Power control circuitry supports system power on from date/time alarm or key closure
- Automatic battery backup and write protection to external SRAM
- Crystal select bit allows RTC to operate with 6 pF or 12.5 pF crystal
- 114 bytes user NVRAM
- Auxiliary battery input
- RAM clear input
- Century register
- 32 KHz output for power management
- 32-bit V_{CC} powered elapsed time counter
- 32-bit V_{BAT} powered elapsed time counter
- 16-bit power cycle counter
- Compatible with existing BIOS for original DS1287 functions
- Available as chip (DS1688) or stand-alone module with embedded battery and crystal (DS1691)
- Timekeeping algorithm includes leap year compensation valid up to 2100

ORDERING INFORMATION

PART #	DESCRIPTION
DS1688	RTC Chip, 28-pin DIP
DS1688S	RTC Chip, 28-pin SOIC
DS1691	RTC Module; 28-pin DIP

PIN ASSIGNMENT

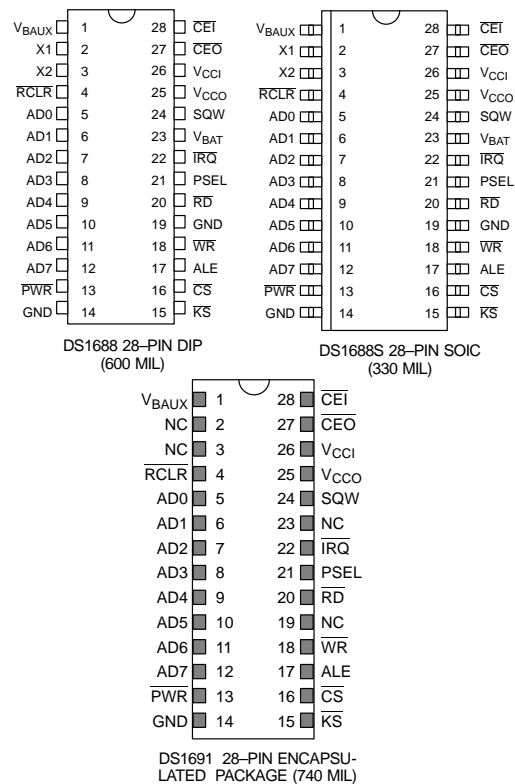

PIN DESCRIPTION

X1	– Crystal Input
X2	– Crystal Output
RCLR	– RAM Clear Input
AD0-AD7	– Mux'ed Address/Data Bus
PWR	– Power-on Interrupt Output
KS	– Kickstart Input
CS	– RTC Chip Select Input
ALE	– RTC Address Strobe
WR	– RTC Write Data Strobe
RD	– RTC Read Data Strobe
V_{CCO}	– RAM Power Supply Output

$\overline{\text{IRQ}}$	– Interrupt Request Output
SQW	– Square Wave Output
V_{CCI}	– +3 or +5 Volt Main Supply
GND	– Ground
V_{BAT}	– Battery + Supply
V_{BAUX}	– Auxiliary Battery Supply
PSEL	– +3 or +5 Volt Power Select
$\overline{\text{CEI}}$	– RAM Chip Enable In
CEO	– RAM Chip Enable Out

DESCRIPTION

The DS1688/DS1691 is a real time clock (RTC) designed as a successor to the industry standard DS1285, DS1385, DS1485, and DS1585 PC real time clocks. This device provides the industry standard DS1285 clock function with the new feature of either +3.0 or +5.0 volt operation and automatic backup and write protection to an external SRAM. The DS1688 also incorporates a number of enhanced features including a silicon serial number, power on/off control circuitry, 114 bytes of user NVSRAM, power on elapsed timer, and power cycle counter.

Each DS1688/DS1691 is individually manufactured with a unique 64-bit serial number as well as an additional 64-bit customer specific ROM or serial number. The serial number is programmed and tested at Dallas to insure that no two devices are alike. The serial number can be used to electronically identify a system for purposes such as establishment of a network node address or for maintenance tracking. Blocks of available numbers from Dallas Semiconductor can be reserved by the customer.

The serialized RTC's also incorporate power control circuitry which allows the system to be powered on via an external stimulus, such as a keyboard or by a time and date (wake up) alarm. The $\overline{\text{PWR}}$ output pin can be triggered by one or either of these events, and can be used to turn on an external power supply. The $\overline{\text{PWR}}$ pin is under software control, so that when a task is complete, the system power can then be shut down.

The DS1688/DS1691 incorporates a power on elapsed time counter, a power on cycle counter, and a battery powered continuous counter. These three counters provide valuable information for maintenance and warranty requirements.

Automatic backup and write protection for an external SRAM is provided through the V_{CCO} and CEO pins. The lithium energy source used to permanently power the real time clock is also used to retain RAM data in the absence of V_{CC} power through the V_{CCO} pin. The chip enable output to RAM (CEO) is controlled during power transients to prevent data corruption.

The DS1688 is a clock/calendar chip with the features described above. An external crystal and battery are the only components required to maintain time-of-day and memory status in the absence of power. The DS1691 incorporates the DS1688 chip, a 32.768 KHz crystal, and a lithium battery in a complete, self-contained timekeeping module. The entire unit is fully tested at Dallas Semiconductor such that a minimum of 10 years of timekeeping and data retention in the absence of V_{CC} is guaranteed.

For a complete description of operating conditions, electrical characteristics, bus timing, and pin descriptions other than the SQW output, see the DS1689/DS1693 data sheet.

SIGNAL DESCRIPTION

SQW (Square Wave Output) – The SQW output signal functions identical to the DS1689/DS1693 with an exception occurring at power-up. A 32 KHz square wave will be output on this pin, t_{REC} , after a power-up condition has been detected. This condition sets the following bits enabling the 32 KHz output; DV1=1, SQWE=1, and E32K=1. The square wave will be output on this pin if either SQWE=1 or E32K=1.

DS1688 28-PIN DIP

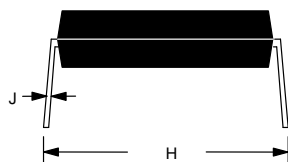
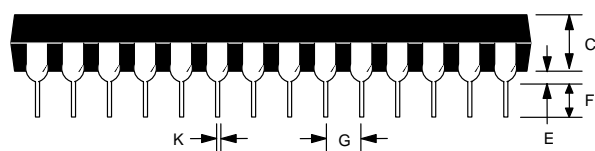
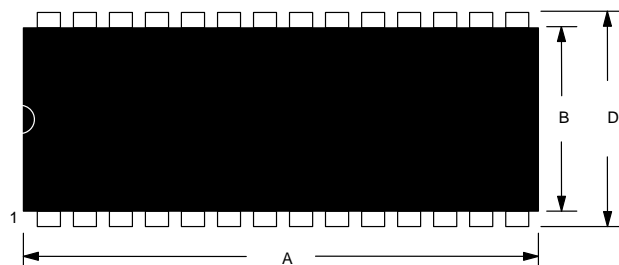

PKG	28-PIN	
	DIM	MIN
A IN.	1.445	1.470
MM	36.70	37.34
B IN.	0.530	0.550
MM	13.46	13.97
C IN.	0.140	0.160
MM	3.56	4.06
D IN.	0.600	0.625
MM	15.24	15.88
E IN.	0.015	0.040
MM	0.38	1.02
F IN.	0.120	0.145
MM	3.05	3.68
G IN.	0.090	0.110
MM	2.29	2.79
H IN.	0.625	0.675
MM	15.88	17.15
J IN.	0.008	0.012
MM	0.20	0.30
K IN.	0.015	0.022
MM	0.38	0.56

DS1688/DS1691

DS1688S 28-PIN SOIC

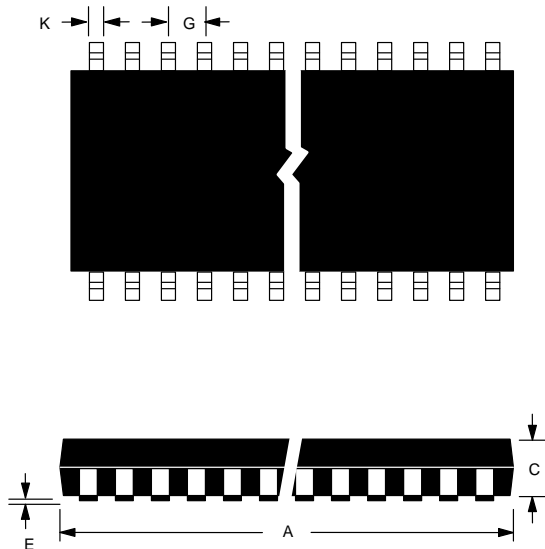

PKG	28-PIN	
	DIM	MIN
A IN.	0.706	0.728
MM	17.93	18.49
B IN.	0.338	0.350
MM	8.58	8.89
C IN.	0.086	0.110
MM	2.18	2.79
D IN.	0.020	0.050
MM	0.58	1.27
E IN.	0.002	0.014
MM	0.05	0.36
F IN.	0.090	0.124
MM	2.29	3.15
G IN.	0.050	BSC
MM	1.27	
H IN.	0.460	0.480
MM	11.68	12.19
J IN.	0.006	0.013
MM	0.15	0.33
K IN.	0.014	0.020
MM	0.36	0.51

DS1691 28-PIN 740 MIL MODULE

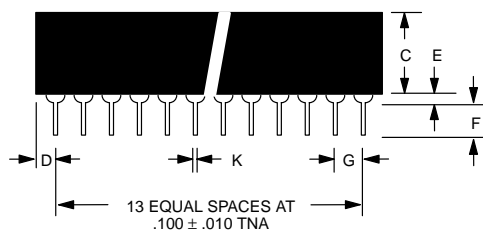
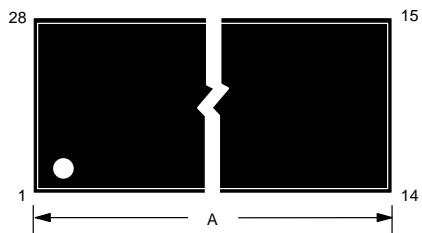

PKG	28-PIN	
DIM	MIN	MAX
A IN. MM	1.520 38.61	1.540 39.12
B IN. MM	0.695 17.65	0.740 18.80
C IN. MM	0.350 8.89	0.375 9.52
D IN. MM	0.100 2.54	0.130 3.30
E IN. MM	0.015 0.38	0.030 0.76
F IN. MM	0.110 2.79	0.140 3.56
G IN. MM	0.090 2.29	0.110 2.79
H IN. MM	0.590 14.99	0.630 16.00
J IN. MM	0.008 0.20	0.012 0.30
K IN. MM	0.015 0.38	0.021 0.53

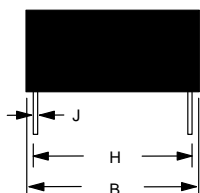

NOTE: PINS 2, 3, 19 AND 23 ARE MISSING BY DESIGN.