

DS34LV87T Enhanced CMOS Quad Differential Line Driver

General Description

The DS34LV87T is a high speed quad differential CMOS driver that meets the requirements of both TIA/EIA-422-B and ITU-T V.11. The CMOS DS34LV87T features low static I_{CC} of 100 μ A max which makes it ideal for battery powered and power conscious applications. The TRI-STATE[®] enable, EN, allows the device to be disabled when the device is not in use to minimize power. The dual enable scheme allows for flexibility in turning devices on or off.

Protection diodes protect all the driver inputs against electrostatic discharge. The driver and enable inputs (DI and EN) are compatible with LVTTTL and LVCMOS devices. Differential outputs have the same V_{OD} ($\geq 2V$) guarantee as the 5V version. The outputs have enhanced ESD Protection providing greater than 7 kV tolerance.

Features

- Meets TIA/EIA-422-B (RS-422) and ITU-T V.11 recommendation
- Interoperable with existing 5V RS-422 networks
- Guaranteed V_{OD} of 2V min over operating conditions
- Balanced output crossover for low EMI (typical within 40 mV of 50% voltage level)
- Low power design (330 μ W 3.3V static)
- ESD ≥ 7 kV on cable I/O pins (HBM)
- Industrial temperature range
- Guaranteed AC parameter:
 - Maximum driver skew: 2 ns
 - Maximum transition time: 10 ns
- Pin compatible with DS26C31
- Available in SOIC packaging

Connection Diagram

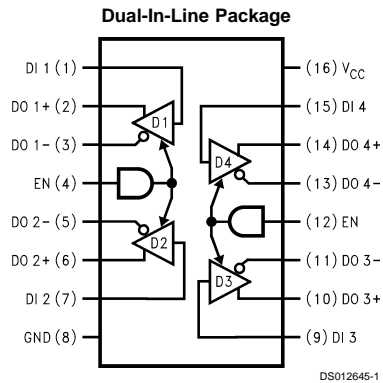

Truth Table

Enables		Input	Outputs
EN	DI	DO+	DO-
L	X	Z	Z
H	H	H	L
H	L	L	H

L = Low logic state
X = Irrelevant
H = High logic state
Z = TRI-STATE

TRI-STATE[®] is a registered trademark of National Semiconductor Corporation.

Absolute Maximum Ratings (Note 1)

If Military/Aerospace specified devices are required, please contact the National Semiconductor Sales Office/Distributors for availability and specifications.

Supply Voltage (V_{CC})	-0.5V to +7V
Enable Input Voltage (EN)	-0.5V to $V_{CC} + 0.5V$
Driver Input Voltage (D_i)	-0.5V to $V_{CC} + 0.5V$
Clamp Diode Current	± 20 mA
DC Output Current, per pin	± 150 mA
Driver Output Voltage (Power Off: DO+, DO-)	-0.5V to +7V
Maximum Package Power Dissipation +25°C	
M Package	1226 mW
N Package	1736 mW
Derate M Package	9.8 mW/°C above +25°C
Derate N Package	13.89 mW/°C above +25°C
Storage Temperature Range	-65°C to +150°C

Lead Temperature Range

(Soldering, 4 sec.)

+260°C

ESD Ratings

(HBM, 1.5k, 100 pF)

Driver Outputs

≥ 7 kV

Other Pins

≥ 2.5 kV

Recommended Operating Conditions

	Min	Typ	Max	Units
Supply Voltage (V_{CC})	3.0	3.3	3.6	V
Operating Free Air Temperature Range (T_A)				
DS34LV87T	-40	25	+85	°C
Input Rise and Fall Time			500	ns

Electrical Characteristics (Notes 2, 3)

Over Supply Voltage and Operating Temperature ranges, unless otherwise specified

Symbol	Parameter	Conditions	Pin	Min	Typ	Max	Units
V_{OD1}	Output Differential Voltage	$R_L = \infty$, (No Load)	DO+,		3.3	4.0	V
V_{OD2}	Output Differential Voltage	$R_L = 100\Omega$ Figure 1	DO-	2	2.6		V
ΔV_{OD2}	Change in Magnitude of Output Differential Voltage			-400	7	400	mV
V_{OD3}	Output Differential Voltage	$R_L = 3900\Omega$ (V.11), Figure 1 (Note 7)			3.2	3.5	V
V_{OC}	Common Mode Voltage	$R_L = 100\Omega$ Figure 1			1.5	2	V
ΔV_{OC}	Change in Magnitude of Common Mode Voltage			-400	6	400	mV
I_{OZ}	TRI-STATE Leakage Current	$V_{OUT} = V_{CC}$ or GND Drivers Disabled			± 0.5	± 20	μA
I_{SC}	Output Short Circuit Current	$V_{OUT} = 0V$ $V_{IN} = V_{CC}$ or GND (Note 4)		-40	-70	-150	mA
I_{OFF}	Output Leakage Current	$V_{CC} = 0V$, $V_{OUT} = 3V$ $V_{CC} = 0V$, $V_{OUT} = -0.25V$			0.03	100	μA
					-0.08	-100	μA
V_{IH}	High Level Input Voltage		DI,	2.0		V_{CC}	V
V_{IL}	Low Level Input Voltage		EN	GND		0.8	V
I_{IH}	High Level Input Current	$V_{IN} = V_{CC}$				10	μA
I_{IL}	Low Level Input Current	$V_{IN} = GND$		-10			μA
V_{CL}	Input Clamp Voltage	$I_{IN} = -18$ mA				-1.5	V
I_{CC}	Power Supply Current	No Load, V_{IN} (all) = V_{CC} or GND	V_{CC}			100	μA

Switching Characteristics (Notes 5, 6)

Over Supply Voltage and Operating Temperature ranges, unless otherwise specified

Symbol	Parameter	Conditions	Min	Typ	Max	Units	
t_{PHLD}	Differential Propagation Delay High to Low	$R_L = 100\Omega$, $C_L = 50$ pF (Figures 2, 3)	6	10.5	16	ns	
t_{PLHD}	Differential Propagation Delay Low to High		6	11	16	ns	
t_{SKD}	Differential Skew $ t_{PHLD} - t_{PLHD} $			0.5	2.0	ns	
t_{SK1}	Skew, Pin to Pin (same device)			1.0	2.0	ns	
t_{SK2}	Skew, Part to Part (Note 8)			3.0	5.0	ns	
t_{TLH}	Differential Transition Time Low to High (20% to 80%)			4.2	10	ns	
t_{THL}	Differential Transition Time High to Low (80% to 20%)			4.7	10	ns	
t_{PHZ}	Disable Time High to Z		(Figures 4, 5)		12	20	ns
t_{PLZ}	Disable Time Low to Z				9	20	ns
t_{PZH}	Enable Time Z to High				22	32	ns
t_{PZL}	Enable Time Z to Low			22	32	ns	
f_{MAX}	Maximum Operating Frequency (Note 9)			32		MHz	

Note 1: "Absolute Maximum Ratings" are those values beyond which the safety of the device cannot be guaranteed. They are not meant to imply that the device should be operated at these limits. The table of "Electrical Characteristics" specifies conditions of device operation.

Note 2: Current into device pins is defined as positive. Current out of device pins is defined as negative. All voltages are referenced to ground except differential voltages V_{OD1} , V_{OD2} , V_{OD3} .

Note 3: All typical values are given for $V_{CC} = 3.3V$ and $T_A = +25^\circ C$.

Note 4: Only one output shorted at a time. The output (true or complement) is configured High.

Note 5: $f = 1$ MHz, t_r and $t_f \leq 6$ ns (10% to 90%).

Note 6: See TIA/EIA-422-B specifications for exact test conditions.

Note 7: This specification limit is for compliance with TIA/EIA-422-B and ITU-T V.11.

Note 8: Devices are at the same V_{CC} and within $5^\circ C$ within the operating temperature range.

Note 9: All channels switching, output duty cycle criteria is 40%/60% measured at 50%. This parameter is guaranteed by design and characterization.

Parameter Measurement Information

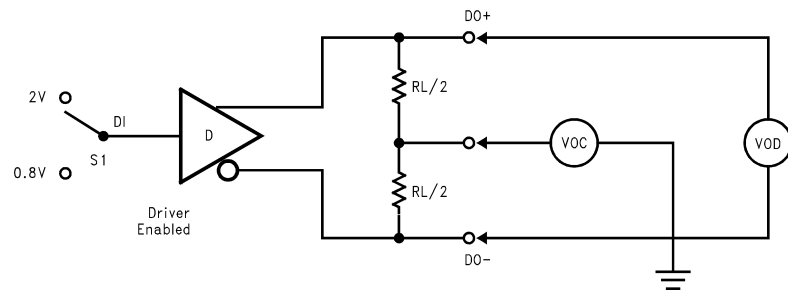
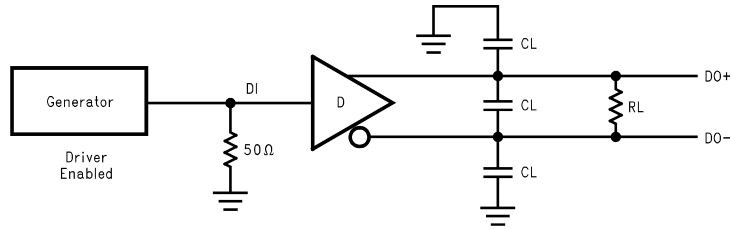

FIGURE 1. Differential Driver DC Test Circuit

DS012645-2

Parameter Measurement Information (Continued)



DS012645-3

FIGURE 2. Differential Driver Propagation Delay and Transition Time Test Circuit

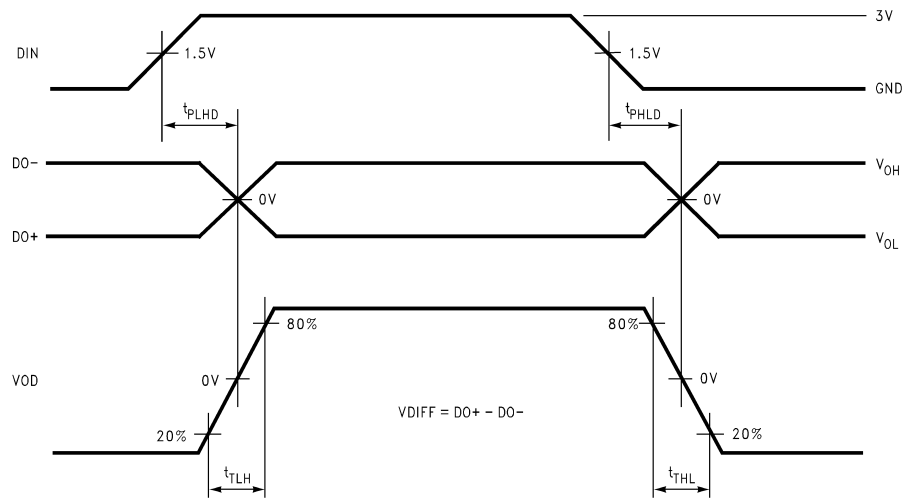

DS012645-4

FIGURE 3. Differential Driver Propagation Delay and Transition Time Waveforms

Note 10: Generator waveform for all tests unless otherwise specified: $f = 1 \text{ MHz}$, Duty Cycle = 50%, $Z_0 = 50 \Omega$, $t_r \leq 10 \text{ ns}$, $t_f \leq 10 \text{ ns}$.

Note 11: C_L includes probe and fixture capacitance.

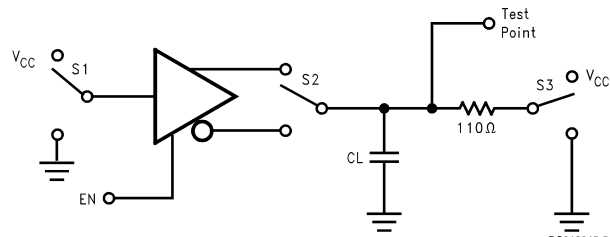

DS012645-5

FIGURE 4. Driver Single-Ended TRI-STATE Test Circuit

Parameter Measurement Information (Continued)

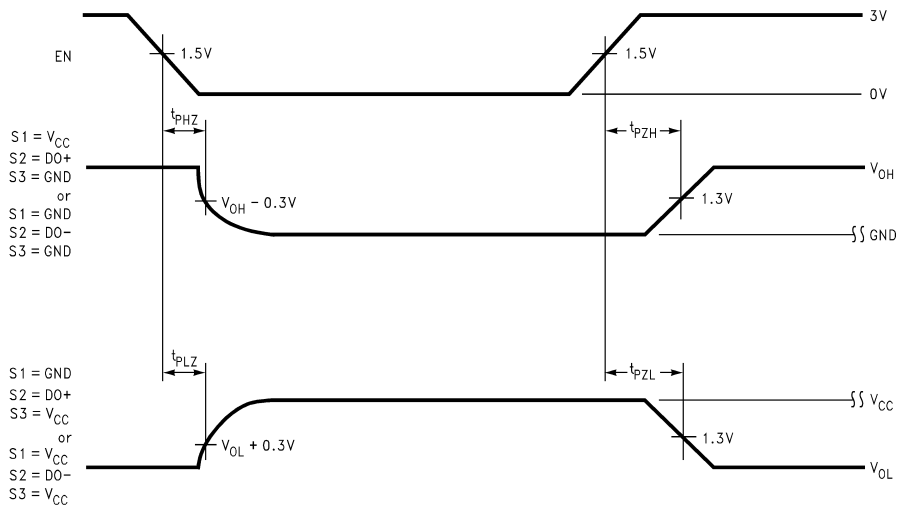

FIGURE 5. Driver Single-Ended TRI-STATE Waveforms

Typical Application Information

General application guidelines and hints for differential drivers and receivers may be found in the following application notes:

AN-214, AN-457, AN-805, AN-847, AN-903, AN-912, AN-916.

Power Decoupling Recommendations:

Bypass caps must be used on power pins. High frequency ceramic (surface mount is recommended) 0.1 μF in parallel with 0.01 μF at the power supply pin. A 10 μF or greater tantalum or electrolytic should be connected at the power entry point on the printed circuit board.

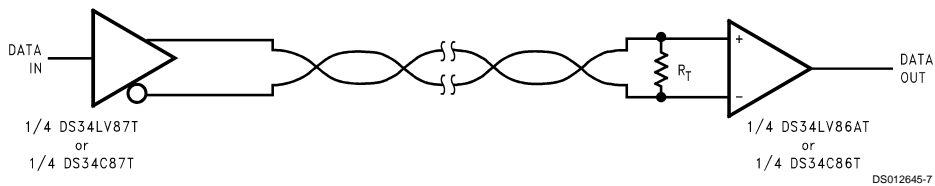

R_T is optional although highly recommended to reduce reflection

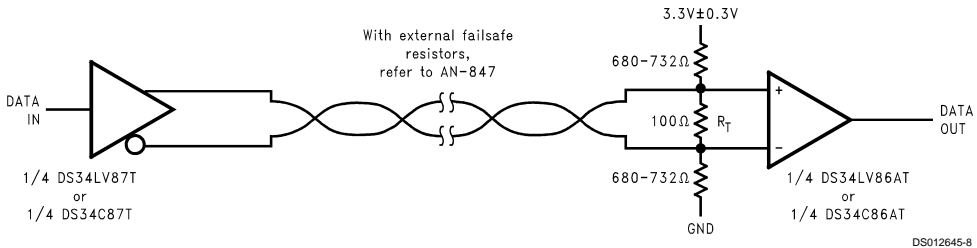

FIGURE 6. Typical Driver Connection

Typical Application Information (Continued)

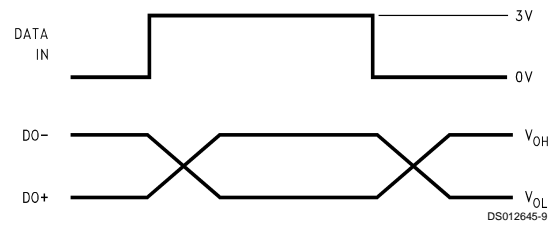
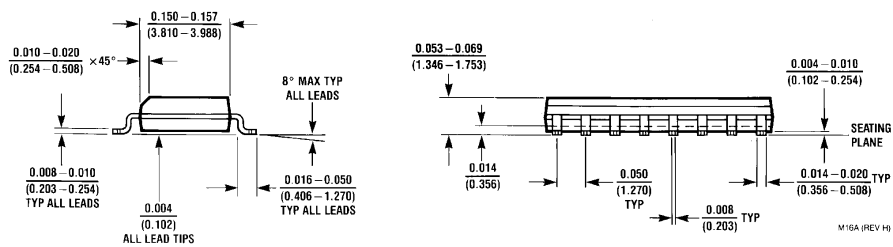
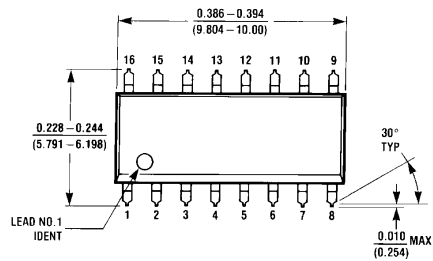
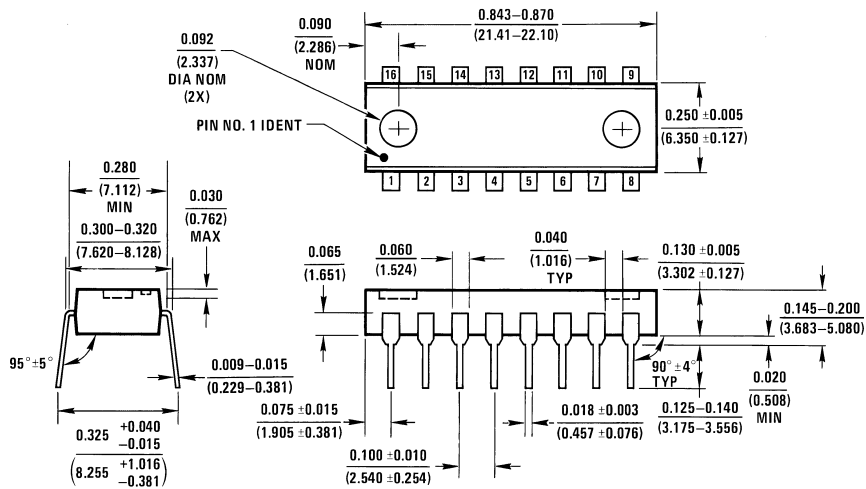

FIGURE 7. Typical Driver Output Waveforms

Physical Dimensions inches (millimeters) unless otherwise noted



16-Lead Molded Small Outline Package (M)
Order Number DS34LV87TM
NS Package Number M16A



16-Lead Molded Dual-In-Line Package (N)
Order Number DS34LV87TN
NS Package Number N16A

LIFE SUPPORT POLICY

NATIONAL'S PRODUCTS ARE NOT AUTHORIZED FOR USE AS CRITICAL COMPONENTS IN LIFE SUPPORT DEVICES OR SYSTEMS WITHOUT THE EXPRESS WRITTEN APPROVAL OF THE PRESIDENT OF NATIONAL SEMICONDUCTOR CORPORATION. As used herein:

1. Life support devices or systems are devices or systems which, (a) are intended for surgical implant into the body, or (b) support or sustain life, and whose failure to perform when properly used in accordance with instructions for use provided in the labeling, can be reasonably expected to result in a significant injury to the user.
2. A critical component in any component of a life support device or system whose failure to perform can be reasonably expected to cause the failure of the life support device or system, or to affect its safety or effectiveness.



National Semiconductor Corporation
Americas
Tel: 1-800-272-9959
Fax: 1-800-737-7018
Email: support@nsc.com

www.national.com

National Semiconductor Europe
Fax: +49 (0) 1 80-530 85 86
Email: europe.support@nsc.com
Deutsch Tel: +49 (0) 1 80-530 85 85
English Tel: +49 (0) 1 80-532 78 32
Français Tel: +49 (0) 1 80-532 93 58
Italiano Tel: +49 (0) 1 80-534 16 80

National Semiconductor Asia Pacific Customer Response Group
Tel: 65-2544466
Fax: 65-2504466
Email: sea.support@nsc.com

National Semiconductor Japan Ltd.
Tel: 81-3-5620-6175
Fax: 81-3-5620-6179