

DS3883A BTL 9-Bit Data Transceiver

General Description

The DS3883A is one in a series of transceivers designed specifically for the implementation of high performance Futurebus+ and proprietary bus interfaces. The DS3883A, is a BTL 9-bit Transceiver designed to conform to IEEE 1194.1 (Backplane Transceiver Logic—BTL) as specified in the IEEE 896.2 Futurebus+ specification. Utilization of the DS3883A simplifies the implementation of byte wide address/data with parity lines and also may be used for the Futurebus+ status, tag and command lines.

The DS3883A driver output configuration is an NPN open collector which allows Wired-OR connection on the bus. Each driver output incorporates a Schottky diode in series with its collector to isolate the transistor output capacitance from the bus thus reducing the bus loading in the inactive state. The combined output capacitance of the driver and receiver input is less than 5 pF. The driver also has high sink current capability to comply with the bus loading requirements defined within IEEE 1194.1 BTL specification.

Backplane Transceiver Logic (BTL) is a signaling standard that was invented and first introduced by National Semiconductor, then developed by the IEEE to enhance the performance of backplane buses. BTL compatible transceivers feature low output capacitance drivers to minimize bus loading, a 1V nominal signal swing for reduced power consumption and receivers with precision thresholds for maximum noise immunity. BTL eliminates settling time delays that severely limit TTL bus performance, and thus provide significantly higher bus transfer rates. The backplane bus is intended to be operated with termination resistors (selected to match the bus impedance) connected to 2.1V at both ends. The low voltage is typically 1V.

Separate ground pins are provided for each BTL output to minimize induced ground noise during simultaneous switching. The unique driver circuitry meets the maximum slew rate of 0.5 V/ns which allows controlled rise and fall times to reduce noise coupling to adjacent lines. The transceiver's control and driver inputs are designed with high impedance PNP input structures and are fully TTL compatible.

The receiver is a high speed comparator that utilizes a bandgap reference for precision threshold control allowing maximum noise immunity to the BTL 1V signaling level. Separate QV_{CC} and QGND pins are provided to minimize the effects of high current switching noise. The output is TRI-STATE® and fully TTL compatible.

The DS3883A supports live insertion as defined in 896.2 through the LI (Live Insertion) pin. To implement live insertion the LI pin should be connected to the live insertion power connector. If this function is not supported the LI pin must be tied to the V_{CC} pin. The DS3883A also provides glitch free power up/down protection during power sequencing.

The DS3883A has two types of power connections in addition to the LI pin. They are the Logic V_{CC} (V_{CC}) and the Quiet V_{CC} (QV_{CC}). There are two logic V_{CC} pins on the DS3883 that provide the supply voltage for the logic and control circuitry. Multiple power pins reduce the effects of package inductance and thereby minimize switching noise. As these pins are common to the V_{CC} bus internal to the device, a voltage delta should never exist between these pins and the voltage difference between V_{CC} and QV_{CC} should never exceed $\pm 0.5V$ because of ESD circuitry.

Additionally, the ESD circuitry between the V_{CC} pins and all other pins except for BTL I/O's and LI pins requires that any voltage on these pins should not exceed the voltage on $V_{CC} + 0.5V$.

There are three different types of ground pins on the DS3883A. They are the logic ground (GND), BTL grounds (B0GND–B8GND) and the Bandgap reference ground (QGND). All of these ground reference pins are isolated within the chip to minimize the effects of high current switching transients. For optimum performance the QGND should be returned to the connector through a quiet channel that does not carry transient switching current. The GND and B0GND–B8GND should be connected to the nearest backplane ground pin with the shortest possible path.

Since many different grounding schemes could be implemented and ESD circuitry exists on the DS3883, it is important to note that any voltage difference between ground pins, QGND, GND or B0GND–B8GND should not exceed $\pm 0.5V$ including power-up/down sequencing.

When CD (Chip Disable) is high, An and Bn are in a high impedance state. To transmit data (An to Bn) the T/R signal is high. To receive data (Bn to An) the T/R signal is low.

Features

- 9-bit Inverting BTL transceiver meets IEEE 1194.1 standard on Backplane Transceiver Logic (BTL)
- Supports live insertion
- Glitch free power-up/down protection
- Typically less than 5 pF bus-port capacitance
- Low bus-port voltage swing (typically 1V) at 80 mA
- Open collector bus-port output allows Wired-OR
- Controlled rise and fall time to reduce noise coupling
- TTL compatible driver and control inputs
- Built in bandgap reference with separate QV_{CC} and QGND pins for precise receiver thresholds
- Exceeds 2 kV ESD (Human Body Model)
- Individual bus-port ground pins minimize ground bounce
- Tight skew (1 ns typical)

Connection Diagram

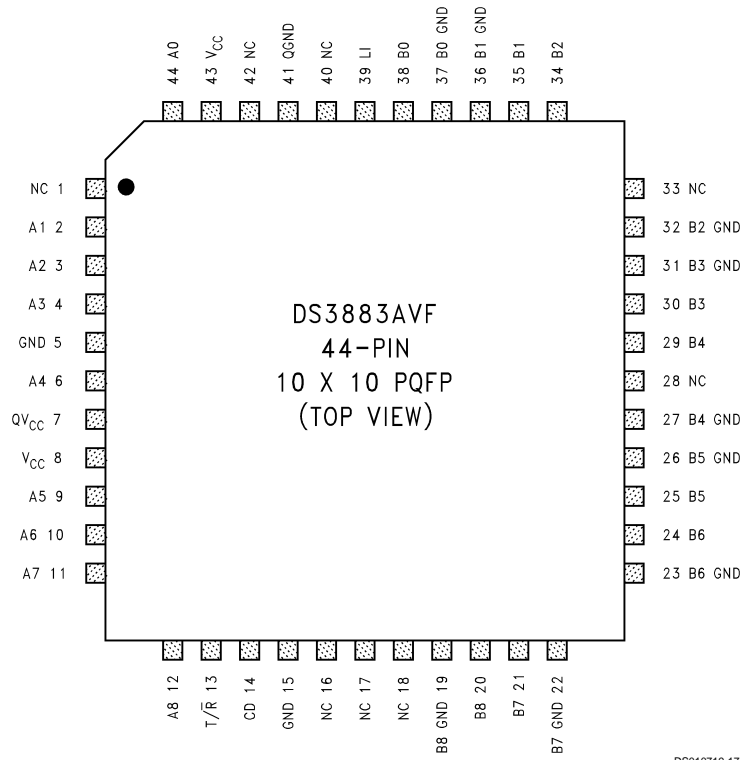

**Order Number DS3883AVF
See NS Package Number VF44B**

DS010719-17

Absolute Maximum Ratings (Note 1)

If Military/Aerospace specified devices are required, please contact the National Semiconductor Sales Office/ Distributors for availability and specifications.

Supply Voltage	6.5V
Control Input Voltage	6.5V
Driver Input and Receiver Output	5.5V
Receiver Input Current	±15 mA
Bus Termination Voltage	2.4V
Power Dissipation at 25°C	
PQFP (VF44B)	1.3W
Derate PQFP Package (VF44B)	11.1 mW/°C

Storage Temperature Range	-65°C to +150°C
Lead Temperature (Soldering, 4 seconds)	260°C

Recommended Operating Conditions

	Min	Max	Units
Supply Voltage, V_{CC}	4.5	5.5	V
Bus Termination Voltage (V_T)	2.06	2.14	V
Operating Free Air Temperature	0	70	°C

DC Electrical Characteristics (Notes 2, 3)

$T_A = 0^\circ\text{C}$ to $+70^\circ\text{C}$, $V_{CC} = 5V \pm 10\%$

Symbol	Parameter	Conditions	Min	Typ	Max	Units
DRIVER AND CONTROL INPUT (CD, T/R, An)						
V_{IH}	Minimum Input High Voltage		2.0			V
V_{IL}	Maximum Input Low Voltage				0.8	V
I_I	Input Leakage Current	$V_{IN} = V_{CC} = 5.5V$			250	µA
I_{IH}	Input High Current	$V_{IN} = 2.4V$, AN = CD = 0.5V, T/R = 2.4V			40	µA
I_{IL}	Input Low Current	$V_{IN} = 0.5V$, AN = CD = 0.5V, T/R = 2.4V			-100	µA
V_{CL}	Input Diode Clamp Voltage	$I_{CLAMP} = -12\text{ mA}$			-1.2	V
DRIVER OUTPUT/RECEIVER INPUT (Bn)						
V_{OLB}	Output Low Bus Voltage (Note 5)	An = T/R = 2.4V, CD = 0.5V $I_{OL} = 80\text{ mA}$	0.75	1.0	1.1	V
I_{OFF}	Output Off Low Current	An = 0.5V, T/R = 2.4V, Bn = 0.75V, CD = 0.5V			-200	µA
	Output Off High Current	An = 0.5V, T/R = 2.4V, Bn = 2.1V, CD = 0.5V			200	µA
	Output Off Low Current—Chip Disabled	An = 0.5V, T/R = CD = 2.4V, Bn = 0.75V			-50	µA
	Output Off Low Current—Chip Disabled	An = 0.5V, T/R = CD = 2.4V, Bn = 2.1V			50	µA
V_{TH}	Receiver Input Threshold	T/R = CD = 0.5V	1.47	1.55	1.62	V
V_{CLP}	Positive Clamp Voltage	$V_{CC} = \text{Max or } 0V$, $I_{Bn} = 1\text{ mA}$, CD = T/R = 0V An = 0V	2.4	3.4	4.5	V
		$V_{CC} = \text{Max or } 0V$, $I_{Bn} = 10\text{ mA}$, CD = T/R = 0V An = 0V	2.9	3.9	5.0	V
V_{CLN}	Negative Clamp Voltage	$I_{CLAMP} = -12\text{ mA}$, CD = T/R = 0.5V			-1.2	V
RECEIVER OUTPUT (An)						
V_{OH}	Voltage Output High	Bn = 1.1V, T/R = CD = 0.5V, $I_{OH} = -2\text{ mA}$	2.4	3.2		V
V_{OL}	Voltage Output Low	T/R = CD = 0.5V, Bn = 2.1V, $I_{OL} = 24\text{ mA}$		0.35	0.5	V
		T/R = CD = 0.5V, Bn = 2.1V, $I_{OL} = 8\text{ mA}$		0.35	0.4	V
I_{OZ}	TRI-STATE Leakage Current	An = 2.4V, CD = 2.4V, T/R = 0.5V			10	µA
		An = 0.5V, CD = 2.4V, T/R = 0.5V			-10	µA
I_{OS}	Output Short Circuit Current	Bn = 1.1V, T/R = CD = 0.5V (Note 4)	-40	-70	-100	mA
SUPPLY CURRENT						
I_{CC}	Supply Current: Includes V_{CC} , QV_{CC} and LI	T/R = All An Inputs = 2.4V, CD = 0.5V			62	mA
		CD = T/R = 0.5V, All Bn Inputs = 2.1V			53	mA
I_{LI}	Live Insertion Current	T/R = CD = An = 0.5V, Bn = Open, $V_{CC} = QV_{CC} = 5.5V$			2.2	mA
		T/R = All An = 2.4V, CD = 0.5V, Bn = Open $V_{CC} = QV_{CC} = 5.5V$			4.5	mA

DC Electrical Characteristics (Notes 2, 3) (Continued)

Note 1: "Absolute Maximum Ratings" are those beyond which the safety of the device cannot be guaranteed. They are not meant to imply that the device should be operated at these limits. The table of "Electrical Characteristics" provides conditions for actual device operation.

Note 2: All input and/or output pins shall not exceed $V_{CC} + 0.5V$ and shall not exceed the absolute maximum rating at any time, including power-up and power-down. This prevents the ESD structure from being damaged due to excessive currents flowing from the input and/or output pins to QV_{CC} and V_{CC} . There is a diode between each input and/or output to V_{CC} which is forward biased when incorrect sequencing is applied. I1 and Bn pins do not have power sequencing requirements with respect to V_{CC} and QV_{CC} .

Note 3: All currents into device pins are positive; all currents out of device pins are negative. All voltages are referenced to device ground unless otherwise specified. All typical values are specified under these conditions: $V_{CC} = 5V$ and $T_A = 25^\circ C$, unless otherwise stated.

Note 4: Only one output should be shorted at a time, and duration of the short should not exceed one second.

Note 5: Referenced to appropriate signal ground. Do not exceed maximum power dissipation of package.

AC Electrical Characteristics (Note 6)

$T_A = 0^\circ C$ to $+70^\circ C$, $V_{CC} = 5V \pm 10\%$

Symbol	Parameter	Conditions	Min	Typ	Max	Units		
DRIVER								
t_{PHL}	An to Bn	Propagation Delay	CD = 0V, T/R = 3V		1	3.5	6	ns
t_{PLH}			(Figure 1 and Figure 2)		1	3.5	6	ns
t_{PHL}	CD to Bn	Enable Time	T/R = An = 3V		3	6	9	ns
t_{PLH}		Disable Time	(Figure 1 and Figure 3)		2.5	5	8	ns
t_{PHL}	T/R to Bn	Enable Time	(Figure 8 and Figure 9)		9	13.5	18	ns
t_{PLH}		Disable Time	CD = 0V		2	6	10	ns
t_r	Transition Time — Rise/Fall		(Figure 1 and Figure 2)		1	2.5	4.5	ns
t_f	20% to 80%		CD = 0V, T/R = 3V (Note 10)		1	2	4.5	ns
SR	Slew Rate is Calculated from 1.3V to 1.8V		(Figure 1 and Figure 2) (Note 10)				0.5	V/ns
t_{SKEW}	An to Bn Skew (Same Package)		(Note 7)			1	3.5	ns
RECEIVER								
t_{PHL}	Bn to An		CD = T/R = 0V		2	4	7	ns
t_{PLH}			(Figure 4 and Figure 5)		1.5	4.5	7.5	ns
t_{PLZ}	CD to An	Disable Time	Bn = 2.1V, T/R = 0V		4	8	12	ns
t_{PZL}		Enable Time	(Figure 6 and Figure 7)		2.5	6	9	ns
t_{PHZ}		Disable Time	Bn = 1.1V, T/R = 0V		3	6.5	10	ns
t_{PZH}		Enable Time	(Figure 6 and Figure 7)		2	6	10	ns
t_{PLZ}	T/R to An	Disable Time	CD = 0V Bn = 2.1V		3	7	12	ns
t_{PZL}		Enable Time	(Figure 8 and Figure 9)		4	10	16	ns
t_{PHZ}		Disable Time	Bn = 1.1V, CD = 0V		2	6.5	10	ns
t_{PZH}		Enable Time	(Figure 6 and Figure 7)		3	7	11	ns
t_{SKEW}	Bn to An Skew (Same Package)		(Note 7)			1	3.5	ns
PARAMETERS NOT TESTED								
C_{output}	BTL Output Capacitance		(Note 8)			5		pF
t_{NR}	Noise Rejection		(Note 9)			1		ns

Note 6: Input waveforms shall have a rise/fall time of 3 ns. Propagation delays are measured with a single output switching.

Note 7: t_{SKEW} is an absolute value defined as differences seen in propagation delays between drivers in the same package with identical load conditions.

Note 8: The parameter is tested using TDR techniques described in 1194.0 BTL backplane Design Guide.

Note 9: This parameter is tested during device characterization. The measurement revealed that the part will reject 1 ns pulse widths.

Note 10: Futurebus+ transceivers are required to limit bus signal rise and fall times to no faster than 0.5 V/ns, measured between 1.3V and 1.8V (approximately 20% to 80% of nominal voltage swing). The rise and fall times are measured with a transceiver loading equivalent to 12.5Ω tied to +2.1V DC.

Pin Description

Pin Name	Number of Pins	Input/Output	Description
A0–A8	9	I/O	TTL TRI-STATE receiver output and driver input
B0–B8	9	I/O	BTL receiver input and driver output
B0GND–B8GND	9	NA	Parallel driver grounds reduce ground bounce due to high current switching of driver outputs. (Note 11)
CD	1	I	Chip Disable
GND	2	NA	Ground for switching circuits. (Note 11)
LI	1	NA	Power supply for live insertion. Boards that require live insertion should connect LI to the live insertion pin on the connector. (Note 12)
NC	8	NA	No Connect
QGND	1	NA	Ground for receiver input bandgap reference and non-switching circuits. (Note 11)
QV _{CC}	1	NA	V _{CC} supply for bandgap reference and non-switching circuits. (Note 12)
T/R	1	I	Transmit/Receive — transmit (An to Bn), receive (Bn to An)
V _{CC}	2	NA	V _{CC} supply for switching circuits. (Note 12)

Note 11: The multiplicity of parallel ground paths reduces the effective inductance of bonding wires and leads, which then reduces the noise caused by transients on the ground path. The various ground pins can be tied together provided that the external ground has low inductance. (i.e., ground plane with power pins and many signal pins connected to the backplane ground.) If the external ground floats considerably during transients, precautionary steps should be taken to prevent QGND from moving with reference to the backplane ground. The receiver threshold should have the same ground reference as the signal coming from the backplane. A voltage offset between their grounds will degrade the noise margin.

Note 12: The same considerations for ground are used for V_{CC} in reducing lead inductance (see (Note 11)). QV_{CC} and V_{CC} should be tied together externally. If live insertion is not supported, the LI pin can be tied together with QV_{CC} and V_{CC}.

CD	T/R	An	Bn (BTL)
H	X	Z	H
L	L	L	H
L	L	H	L
L	H	H	L
L	H	L	H

X = High or low logic state
 Z = High impedance state
 L = Low state
 H = High state

Package Thermal Characteristics

Linear Feet per Minute Air Flow (LFPM)	θ_{JA} (°C/W)
	44-Pin PQFP
0	82
225	68
500	60
900	53

Note 13: The above values are typical values and are different from the Absolute Maximum Rating values, which include guardbands.

Logic Diagram

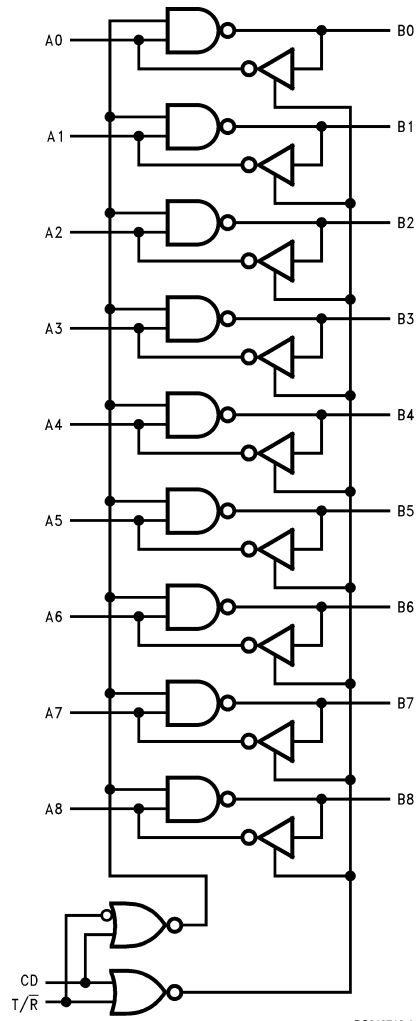

DS010719-1

Test Circuit and Timing Waveforms

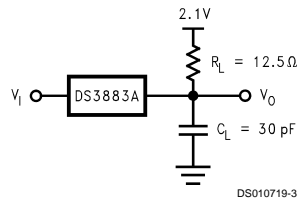

FIGURE 1. Driver Propagation Delay Set-Up

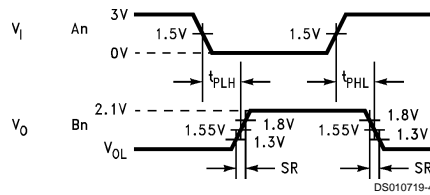

FIGURE 2. Driver: An to Bn, SR

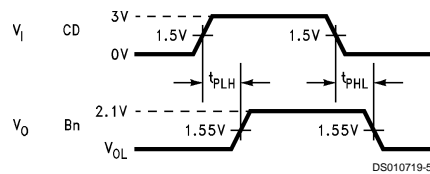
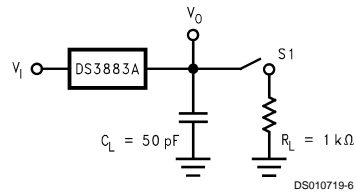

FIGURE 3. Driver: CD to Bn



	Switch Position	
	t_{PLH}	t_{PHL}
S1	Open	Close

FIGURE 4. Receiver Propagation Delay Set-Up

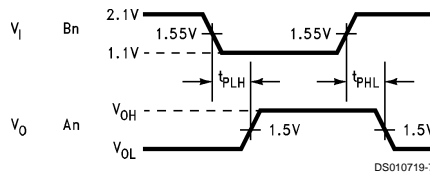

FIGURE 5. Receiver: Bn to An

Test Circuit and Timing Waveforms (Continued)

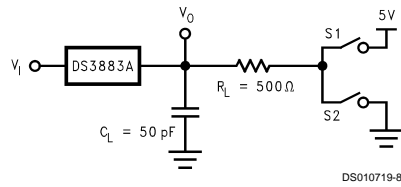

FIGURE 6. Receiver Enable/Disable Set-Up

	Switch Position	
	t_{PZL}	t_{PZH}
	t_{PLZ}	t_{PHZ}
S1	Close	Open
S2	Open	Close

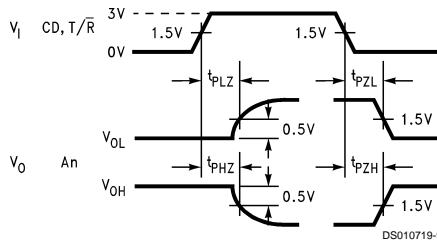

FIGURE 7. Receiver: CD to An, $\overline{T/R}$ to An (t_{PHZ} and t_{PZH} only)

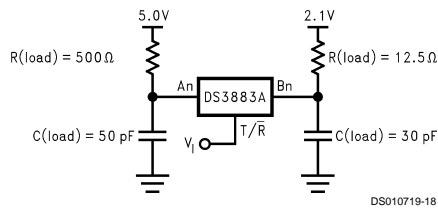
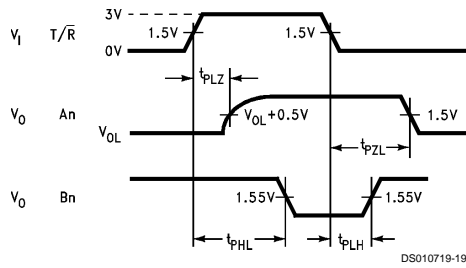
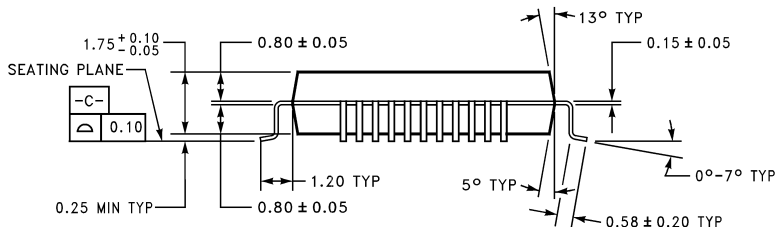
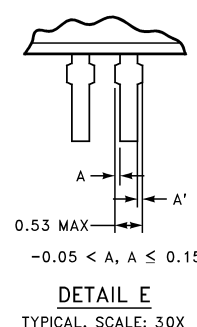
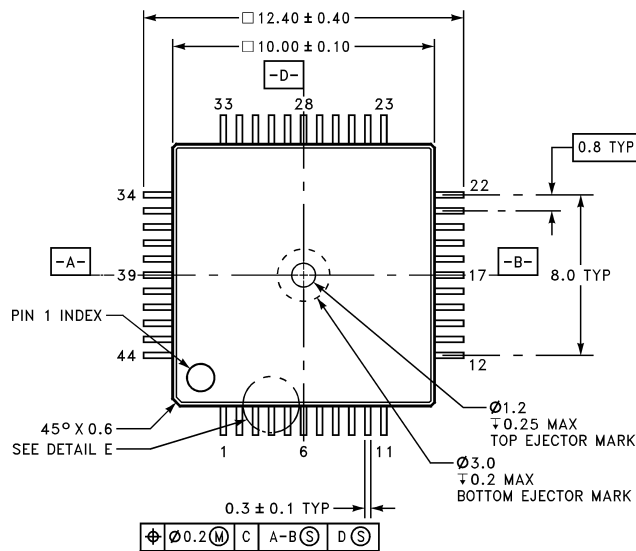

FIGURE 8. $\overline{T/R}$ to An, $\overline{T/R}$ to Bn



**FIGURE 9.
 $\overline{T/R}$ to Bn (t_{PHL} and t_{PLH} only),
 $\overline{T/R}$ to An (t_{PZL} and t_{PLZ} only)**

Physical Dimensions inches (millimeters) unless otherwise noted



VF44B (REV A)

Note: All dimensions in millimeters

**44-Lead Plastic Quad Flatpak
Order Number DS3883AVF
NS Package Number VF44B**

LIFE SUPPORT POLICY

NATIONAL'S PRODUCTS ARE NOT AUTHORIZED FOR USE AS CRITICAL COMPONENTS IN LIFE SUPPORT DEVICES OR SYSTEMS WITHOUT THE EXPRESS WRITTEN APPROVAL OF THE PRESIDENT AND GENERAL COUNSEL OF NATIONAL SEMICONDUCTOR CORPORATION. As used herein:

1. Life support devices or systems are devices or systems which, (a) are intended for surgical implant into the body, or (b) support or sustain life, and whose failure to perform when properly used in accordance with instructions for use provided in the labeling, can be reasonably expected to result in a significant injury to the user.
2. A critical component is any component of a life support device or system whose failure to perform can be reasonably expected to cause the failure of the life support device or system, or to affect its safety or effectiveness.

National Semiconductor Corporation
Americas
Tel: 1-800-272-9959
Fax: 1-800-737-7018
Email: support@nsc.com
www.national.com

National Semiconductor Europe
Fax: +49 (0) 1 80-530 85 86
Email: europe.support@nsc.com
Deutsch Tel: +49 (0) 1 80-530 85 85
English Tel: +49 (0) 1 80-532 78 32
Français Tel: +49 (0) 1 80-532 93 58
Italiano Tel: +49 (0) 1 80-534 16 80

National Semiconductor Asia Pacific Customer Response Group
Tel: 65-2544466
Fax: 65-2504466
Email: sea.support@nsc.com

National Semiconductor Japan Ltd.
Tel: 81-3-5639-7560
Fax: 81-3-5639-7507