



DS38EP100

1 to 5 Gbps, Power-Saver Equalizer for Backplanes and Cables

General Description

National's Power-saver equalizer compensates for transmission medium losses and minimizes medium-induced deterministic jitter. Performance is guaranteed over the full range of 1 to 5 Gbps. The DS38EP100 requires no power to operate. The equalizer operates anywhere in the data path to minimize media-induced deterministic jitter in both FR4 and cable applications. Symmetric I/O structures support full duplex or half duplex applications. Linear compensation is provided independent of line coding or protocol. The device is ideal for both bi-level and multi-level signaling.

The equalizer is available in a 6 pin leadless LLP package with a space saving 2.2 mm X 2.5 mm footprint. This tiny package provides maximum flexibility in placement and routing of the Power-saver equalizer.

Features

- 1 to 5 Gbps Operation
- No Power or Ground Required
- Equalization effective anywhere in data path
- Equalizes CML, LV-PECL, LVDS signals
- Symmetric I/O structures provide equal boost for bi-directional operation
- 7 dB Maximum Boost
- Code independent, 8b/10b or Scrambled
- Supports both bi-level and multi-level signaling
- Extends reach over backplanes and cables
- Compatible with PCI-Express Gen1 and Gen2
- Compatible with XAU1
- Operates in series with existing active Equalizer
- Easy to handle 6 pin LLP

Simplified Application Diagram

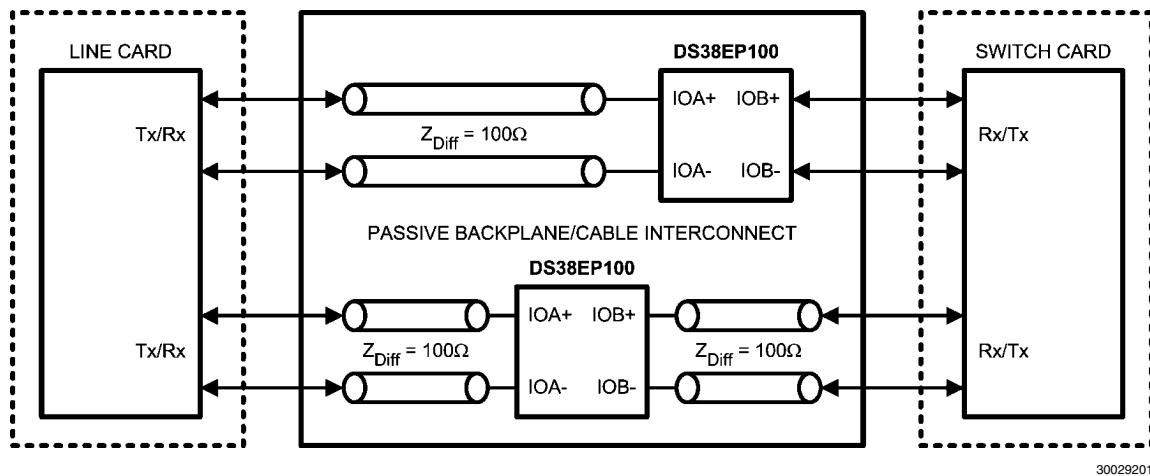

Note: The DS38EP100 provides the flexibility of passing the data from either side of the device. It can be placed anywhere in the data path..

Pin Descriptions

Pin Name	Pin Number	I/O, Type	Description
High Speed Differential I/O			
IOA- IOA+	3 1	I/O	Symmetric differential I/O.
IOB- IOB+	4 6	I/O	Symmetric differential I/O.
NC Exposed Pad	2, 5 DAP	N/A	Reserved. Do not connect.

Note: I = Input / O = Output

Pin Diagram

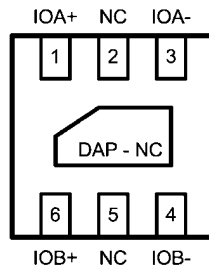

30029205
Bottom View shown
2.2mm x 2.5mm 6-Pin LLP Package
Order number DS38EP100

Absolute Maximum Ratings (Note 1)

If Military/Aerospace specified devices are required, please contact the National Semiconductor Sales Office/ Distributors for availability and specifications.

INPUT/OUTPUT

(IOA+ and IOB+) or (IOA- and IOB-)	+2V
(IOA+ and IOA-) or (IOB+ and IOB-)	+4V
(IOA+ and IOB-) or (IOA- and IOB+)	+4V
Junction Temperature	+150°C
Storage Temperature	-65°C to +150°C

Lead Temperature Soldering, 4 sec	+260°C
ESD Rating HBM, 1.5 k Ω , 100 pF	1.3kV

Recommended Operating Conditions

	Min	Typ	Max	Units
Operating Temperature	-40	25	+85	°C
Bit Rate	1		5	Gbps

Electrical Characteristics (Note 6) Over recommended operating conditions unless other specified. All parameters are guaranteed by test, statistical analysis or design.

Symbol	Parameter	Conditions	Min	Typ (Note 2)	Max	Units
V _{IN}	Input voltage swing	See (Note 3)		1000	3600	mVp-p
	Equalization	2.5 GHz relative to 100MHz		6		dB
R _{LI}	Differential input return loss	100 MHz – 2.5 GHz, with fixture's effect de-embedded		15		dB
R _{LO}	Differential output return loss	100 MHz – 2.5 GHz, with fixture's effect de-embedded. IOA+, or IOB+ = static high.		15		dB
R _{IN}	Input Impedance	Differential across IOA+ and IOA-, or IOB+ and IOB-, Z _{LOAD} = 100 Ω		100		Ω
R _O	Output Impedance	Differential across IOA+ and IOA-, or IOB+ and IOB-, Z _{SOURCE} = 100 Ω		100		Ω
	Through Response	Relative to ideal load, see <i>Figure 2</i> for setup	See <i>Figure 3</i> and <i>Table 1</i> for limits			
R1	Resistance IOA+ to IOA- and IOB+ to IOB-	No load, high impedance on all ports		150		Ω
R2	Resistance IOA+ to IOB+ and IOA- to IOB-	No load, high impedance on all ports		50		Ω
R3	Resistance IOA+ to IOB- and IOA- to IOB+	No load, high impedance on all ports		150		Ω
	DC Gain (IOA/IOB or IOB/IOA)	Z _{LOAD} = 100 Ω		0.4		
DJ1	Residual deterministic jitter	2.5 Gbps, 40 in of 6mil microstrip FR4		0.1		Ulp-p
		See (Note 4)				
DJ2	Residual deterministic jitter	3.125 Gbps, 40 in of 6mil microstrip FR4		0.1	0.15	Ulp-p
		See (Notes 4, 5)				
DJ3	Residual deterministic jitter	3.8 Gbps, 40 in of 6mil microstrip FR4		0.1	0.15	Ulp-p
		See (Notes 4, 5)				
DJ4	Residual deterministic jitter	5 Gbps, 30 in of 6mil microstrip FR4		0.1		Ulp-p
		See (Note 4)				

Note 1: "Absolute Maximum Ratings" indicate limits beyond which damage to the device may occur, including inoperability and degradation of device reliability and/or performance. Functional operation of the device and/or non-degradation at the Absolute Maximum Ratings or other conditions beyond those indicated in the Recommended Operating Conditions is not implied. The Recommended Operating Conditions indicate conditions at which the device is functional and the device should not be operated beyond such conditions.

Note 2: Typical values represent most likely parametric norms, TA = +25 degC, and at the Recommended Operating Conditions at the time of product characterization and are not guaranteed.

Note 3: Differential signal to Equalizer, measured at the input to a transmission line, see point A of *Figure 1*. The transmission line is $Z_0 = 100\Omega$, 6-mil, microstrip in FR4 material.

Note 4: Deterministic jitter is measured at the differential outputs (point C of *Figure 1*), minus the deterministic jitter before the test channel (point A of *Figure 1*). Test pattern: PRBS- 7 .

Note 5: Specification is guaranteed by characterization and is not tested in production.

Note 6: The Electrical Characteristics tables list guaranteed specifications under the listed Recommended Operating Conditions except as otherwise modified or specified by the Electrical Characteristics Conditions and/or Notes. Typical specifications are estimations only and are not guaranteed.

Test Setup Diagrams

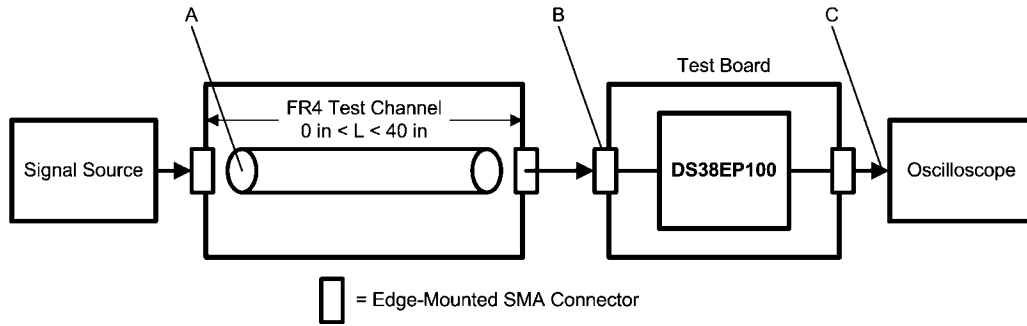

FIGURE 1. Transient Test Setup Diagram

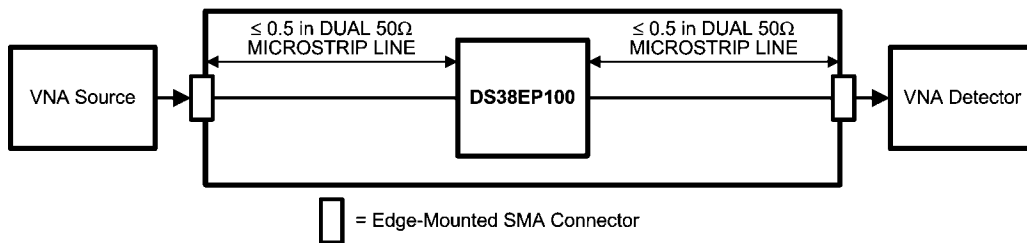

FIGURE 2. Frequency Response Test Circuit

Typical Equalizer Transfer Function

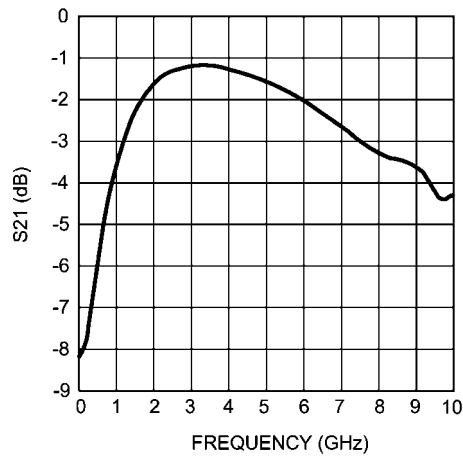
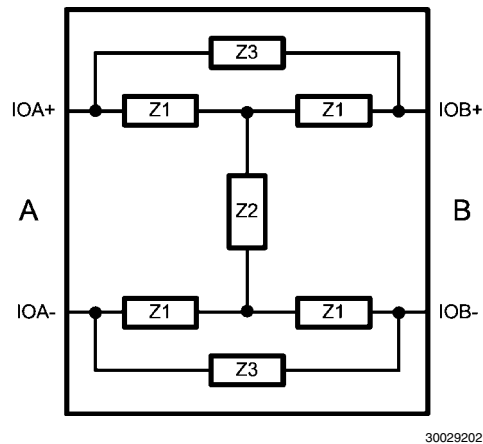

FIGURE 3. Typical Equalizer Transfer Function

TABLE 1. Typical Through Response

Frequency (GHz)	DS38EP100 Attenuation Typ (dB)
0.1	-7.98
0.5	-5.93
1	-3.53
1.5	-2.25
2	-1.58
3	-1.14
4	-1.26
5	-1.54
6	-1.99
7	-2.62
8	-3.26
9	-3.61
10	-4.26

Block Diagram**FIGURE 4. Simplified Block Diagram**

Application Information

DS38EP100 DEVICE DESCRIPTION

The DS38EP100 Power-Saver equalizer is a passive network circuit composed of resistive, capacitive, and inductive components (See *Figure 4*). A differential bridged T-network compensates for the transmission medium losses and minimizes medium-induced deterministic jitter with FR4 and cables. The equalizer attenuates low frequency signals and is a bandpass filter at the resonant frequency. The response is linear and symmetric.

I/O TERMINATIONS

The DS38EP100 I/O impedance is 100Ω differential. The equalizer is designed for 100Ω-balanced differential signals and is not intended for single-ended transmission.

LINEAR COMPENSATION

The unique linear compensation feature of the DS38EP100 combined with the tiny package allows maximum flexibility in placement. The equalizer can be placed anywhere in the data

path and will provide the same compensation at the receiving circuit. (See Simplified Application Diagram)

SYMMETRIC I/O STRUCTURES

The symmetry of the passive equalization network allows bi-directional operation. Signals receive equal compensation regardless of the direction of data flow. (See *Figure 4*).

PCB LAYOUT CONSIDERATIONS FOR DIFFERENTIAL PAIRS AND NO CONNECT PADS

The differential I/Os must have a controlled differential impedance of 100Ω. It is preferable to route all differential lines exclusively on one layer of the board. The use of vias should be avoided if possible. If vias must be used, they should be used sparingly and must be placed symmetrically for each side of a given differential pair. Differential signals should be routed away from other signals and noise sources on the printed circuit board. Pin 2, Pin 5, and the center DAP have to be left as a no connect. Therefore, do not connect the landing pads of these pins to the power or ground plane. See AN-1187 for additional information on the LLP package.

Typical Performance Characteristics

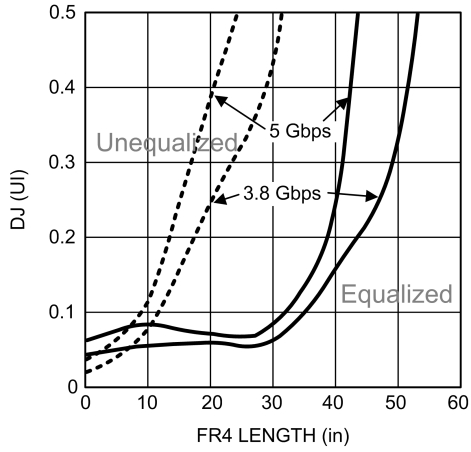

Residual Deterministic Jitter vs. FR4 Length ³⁰⁰²⁹²⁰⁷

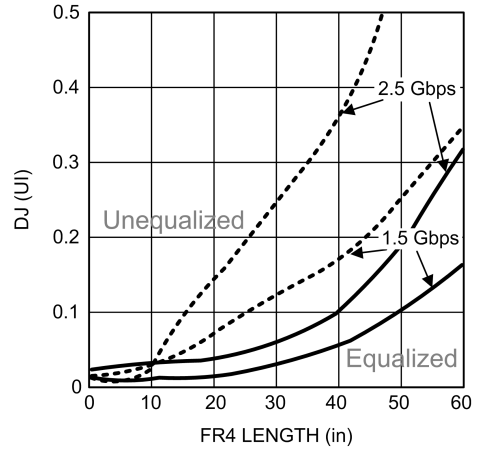

Residual Deterministic Jitter vs. FR4 Length ³⁰⁰²⁹²⁰⁸

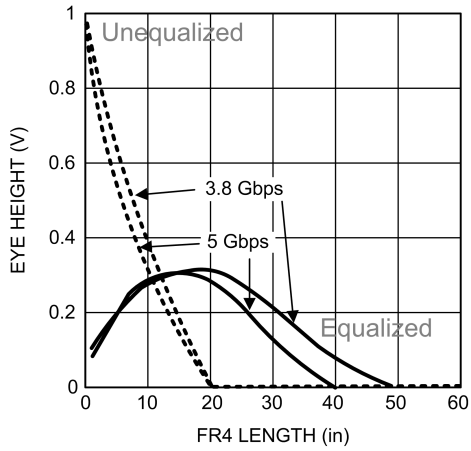

Eye Height vs. FR4 Length ³⁰⁰²⁹²⁰⁹

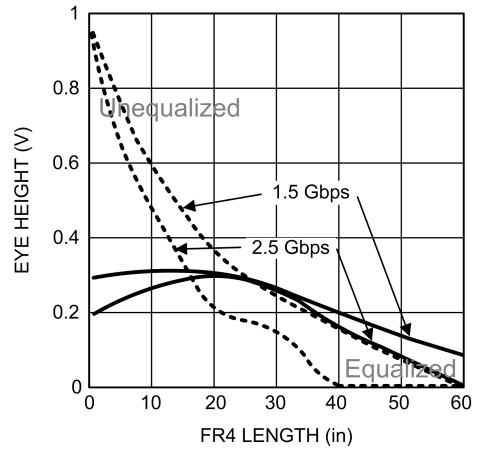

Eye Height vs. FR4 Length ³⁰⁰²⁹²¹⁰

Typical Eye Diagrams — Includes Transmitter Setup, Interconnect, and Device Total Jitter

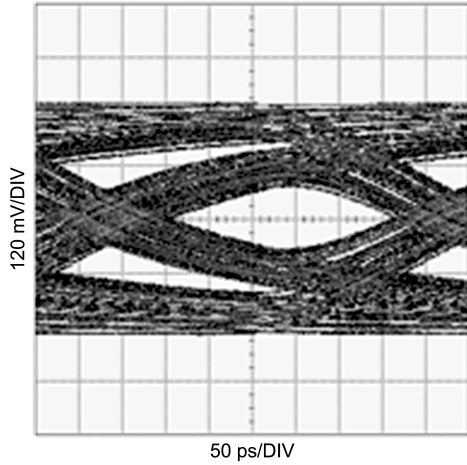

30029211

FIGURE 5. Unequalized Signal (40in FR4, 2.5Gbps, PRBS7)

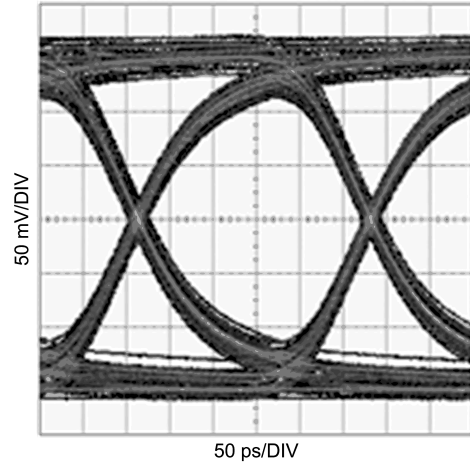

30029213

FIGURE 7. Equalized Signal (Zoom) (40in FR4, 2.5Gbps, PRBS7)

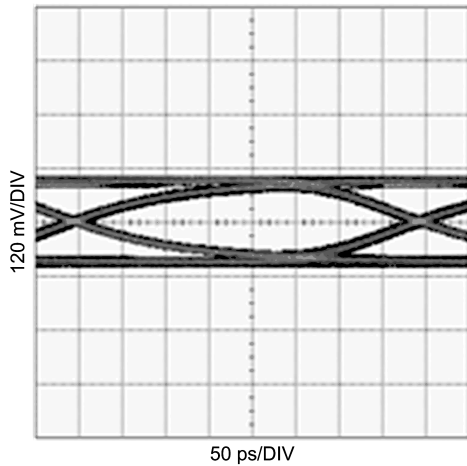

30029212

FIGURE 6. Equalized Signal (40in FR4, 2.5Gbps, PRBS7)

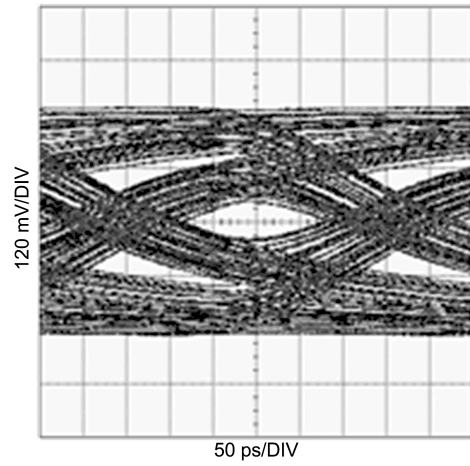

30029214

FIGURE 8. Unequalized Signal (40in FR4, 3.125Gbps, PRBS7)

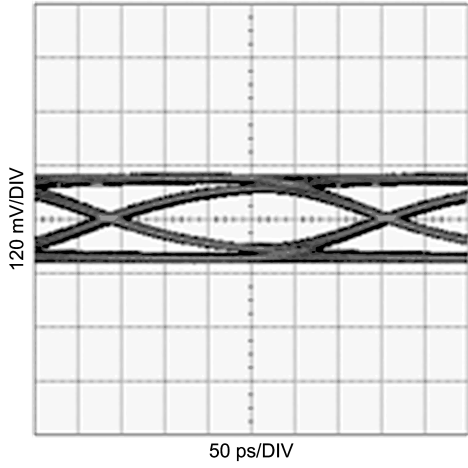

30029215

FIGURE 9. Equalized Signal (40in FR4, 3.125Gbps, PRBS7)

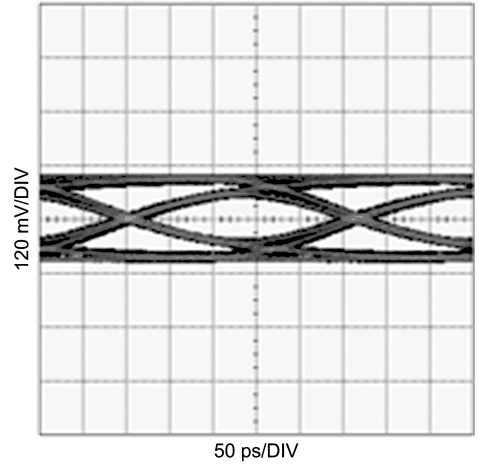

30029218

FIGURE 12. Equalized Signal (40in FR4, 3.8Gbps, PRBS7)

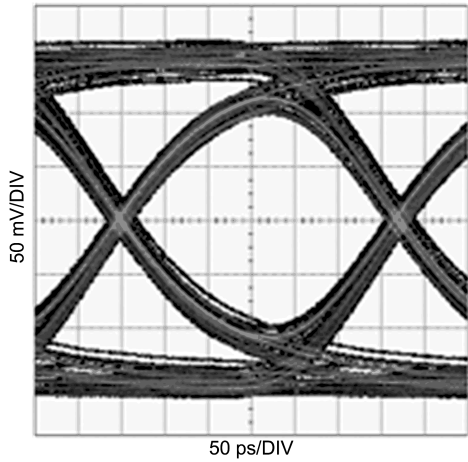

30029216

FIGURE 10. Equalized Signal (Zoom) (40in FR4, 3.125Gbps, PRBS7)

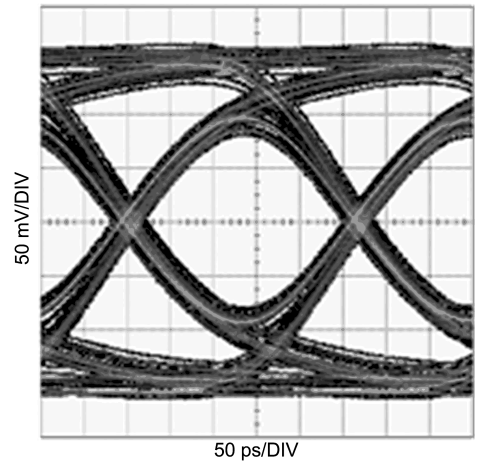

30029219

FIGURE 13. Equalized Signal (Zoom) (40in FR4, 3.8Gbps, PRBS7)

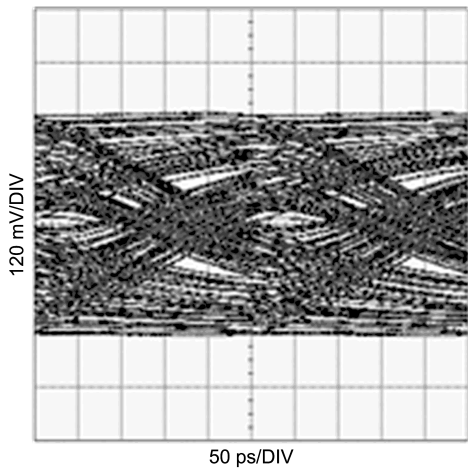

30029217

FIGURE 11. Unequalized Signal (40in FR4, 3.8Gbps, PRBS7)

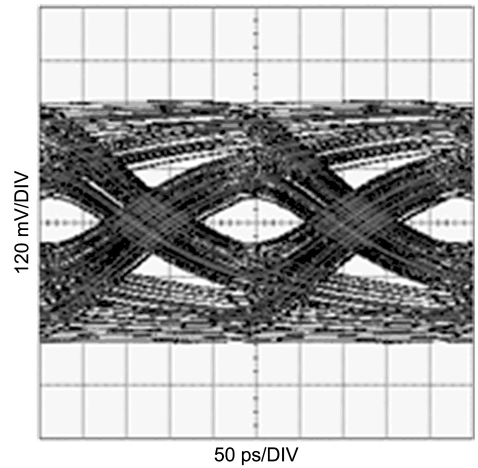

30029220

FIGURE 14. Unequalized Signal (30in FR4, 4.25Gbps, PRBS7)

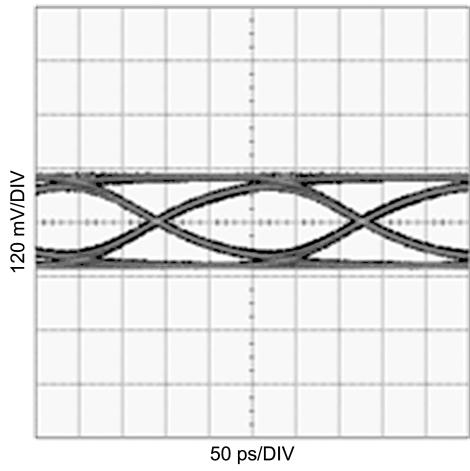

30029221

FIGURE 15. Equalized Signal (30in FR4, 4.25Gbps, PRBS7)

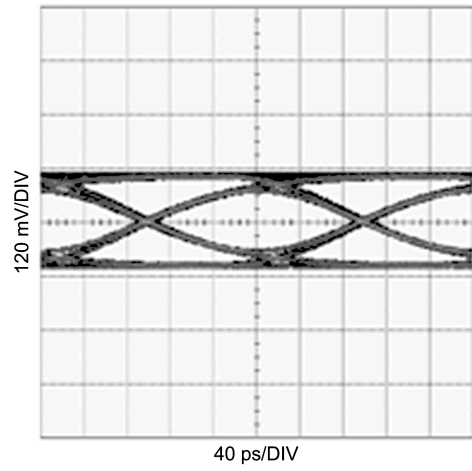

30029224

FIGURE 18. Equalized Signal (30in FR4, 5Gbps, PRBS7)

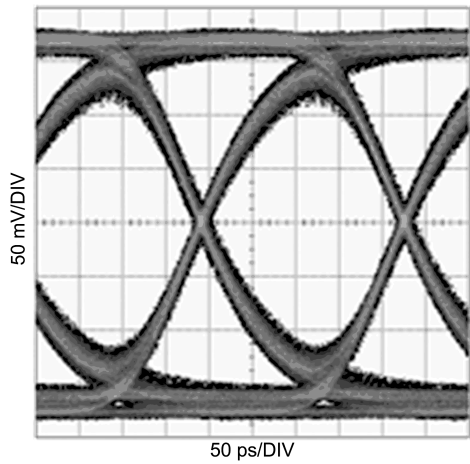

30029222

FIGURE 16. Equalized Signal (Zoom) (30in FR4, 4.25Gbps, PRBS7)

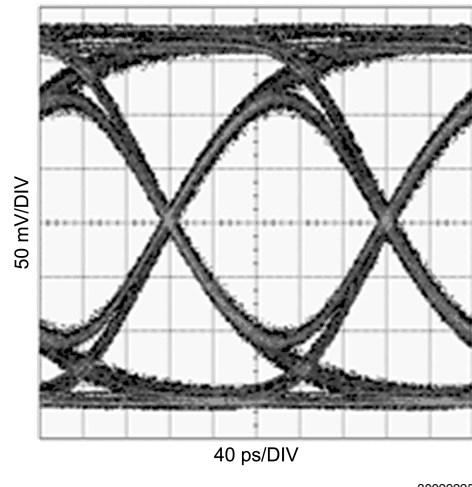

30029225

FIGURE 19. Equalized Signal (Zoom) (30in FR4, 5Gbps, PRBS7)

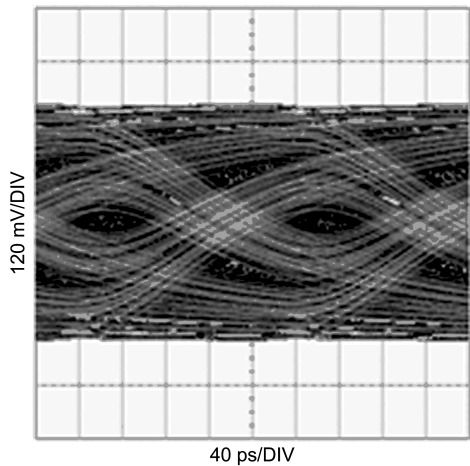

30029223

FIGURE 17. Unequalized Signal (30in FR4, 5Gbps, PRBS7)

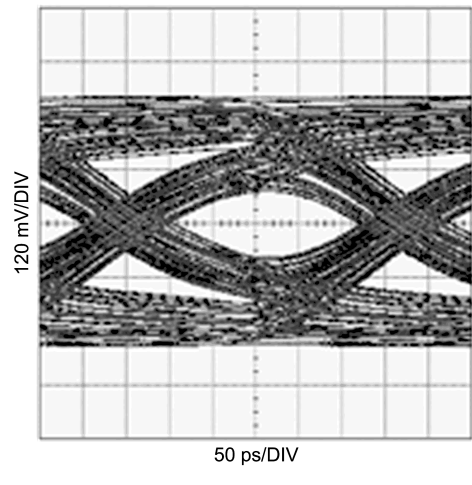

30029226

FIGURE 20. Unequalized Signal (34in Tyco XAUI Backplane, 3.125Gbps, PRBS7)

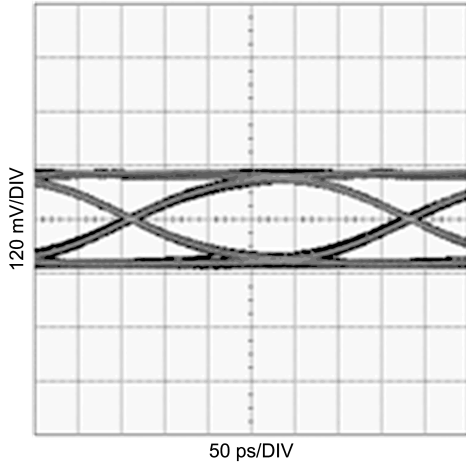

30029227

FIGURE 21. Equalized Signal (34in Tyco XAUI Backplane, 3.125Gbps, PRBS7)

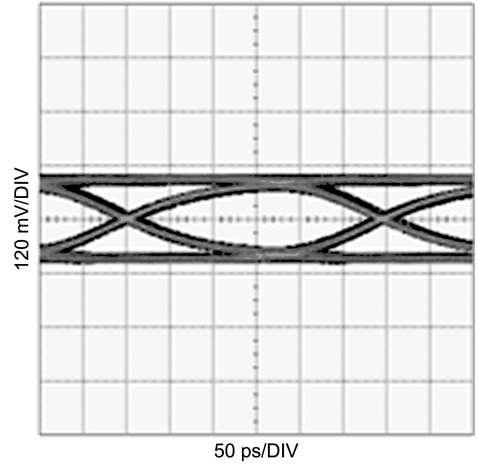

30029230

FIGURE 24. Equalized Signal (5m 28AWG HDMI Cable, 3.4Gbps, PRBS7)

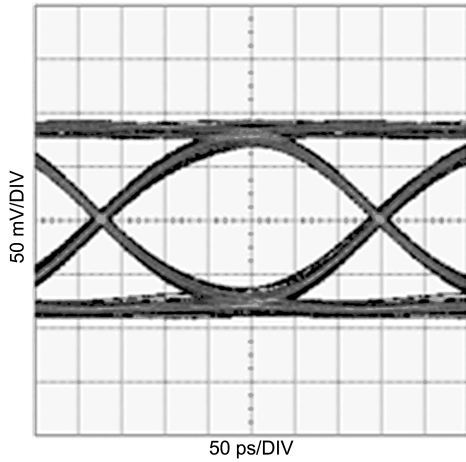

30029228

FIGURE 22. Equalized Signal (Zoom) (34in Tyco XAUI Backplane, 3.125Gbps, PRBS7)

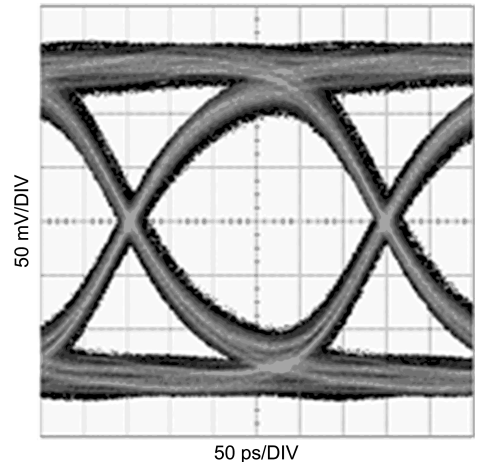

30029231

FIGURE 25. Equalized Signal (Zoom) (5m 28AWG HDMI Cable, 3.4Gbps, PRBS7)

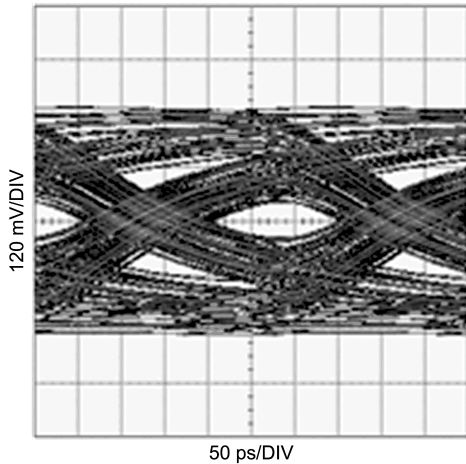

30029229

FIGURE 23. Unequalized Signal (5m 28AWG HDMI Cable, 3.4Gbps, PRBS7)

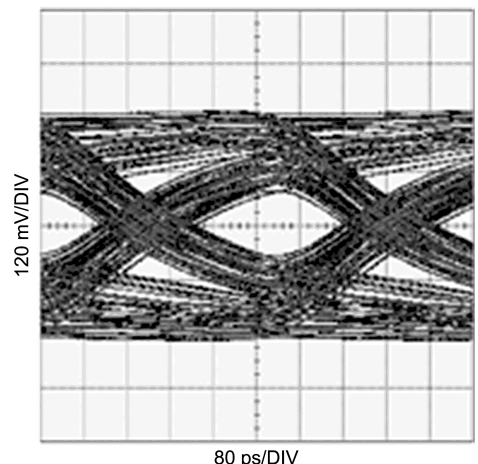

30029232

FIGURE 26. Unequalized Signal (10m 26AWG HDMI Cable, 2.25Gbps, PRBS7)

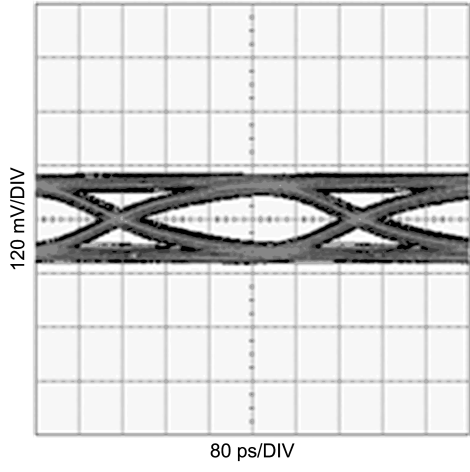

FIGURE 27. Equalized Signal (10m 26AWG HDMI Cable, 2.25Gbps, PRBS7)

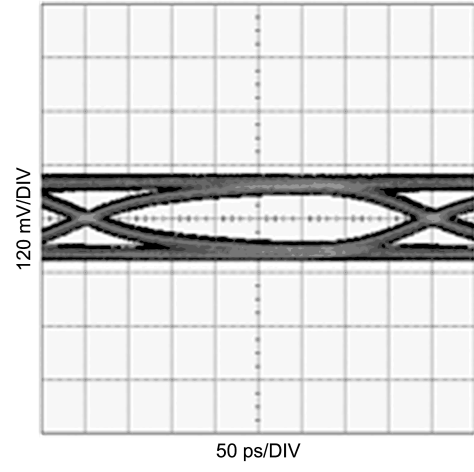

FIGURE 30. Equalized Signal (10m 24AWG PCIe Cable, 2.5Gbps, PRBS7)

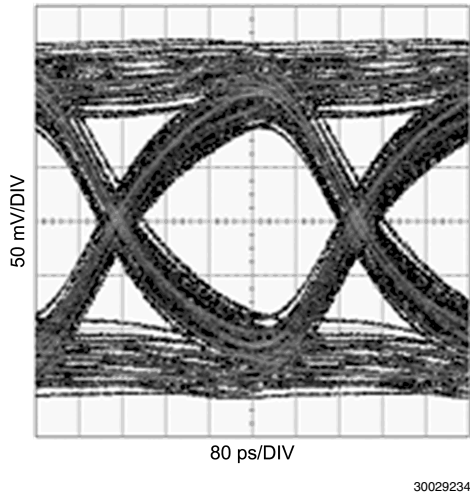

FIGURE 28. Equalized Signal (Zoom) (10m 26AWG HDMI Cable, 2.25Gbps, PRBS7)

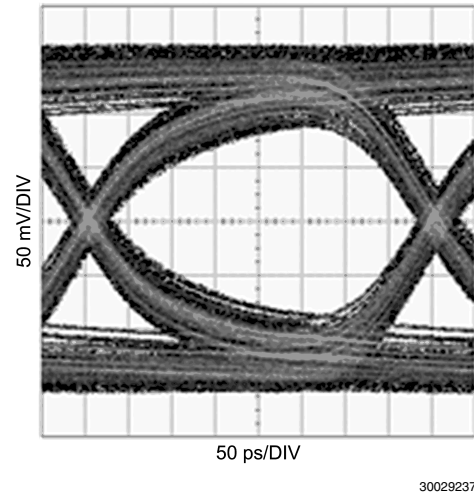

FIGURE 31. Equalized Signal (Zoom) (10m 24AWG PCIe Cable, 2.5Gbps, PRBS7)

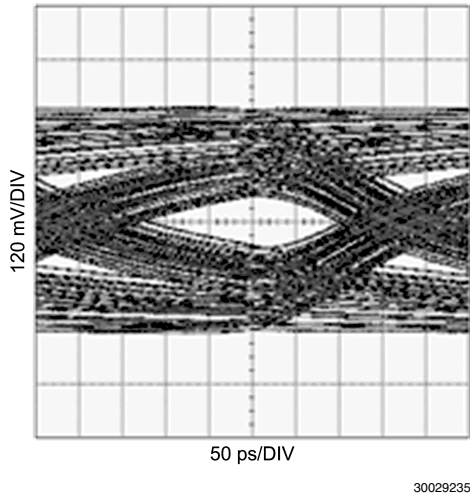

FIGURE 29. Unequalized Signal (10m 24AWG PCIe Cable, 2.5Gbps, PRBS7)

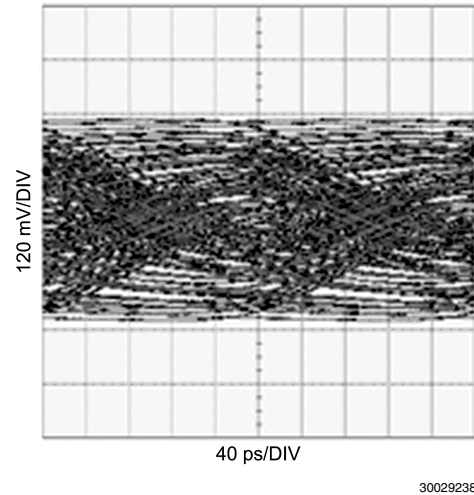

FIGURE 32. Unequalized Signal (10m 24AWG PCIe Cable, 5Gbps, PRBS7)

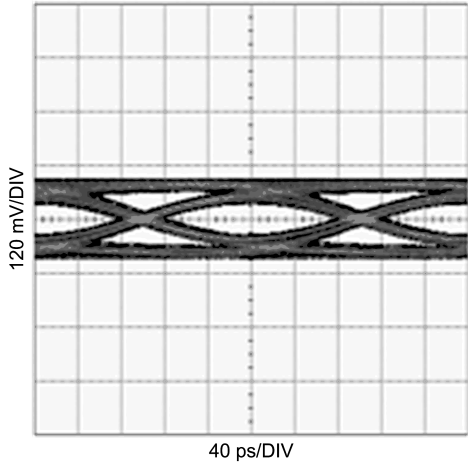

FIGURE 33. Equalized Signal (10m 24AWG PCIe Cable, 5Gbps, PRBS7)

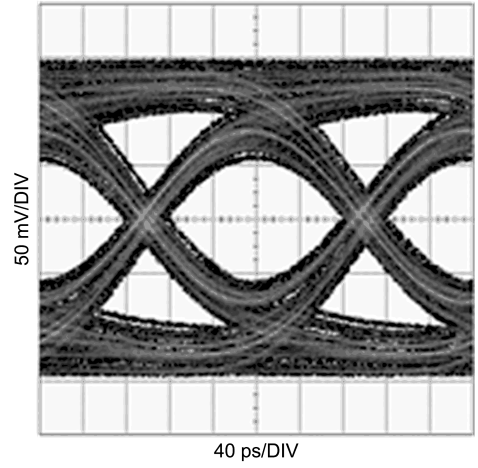
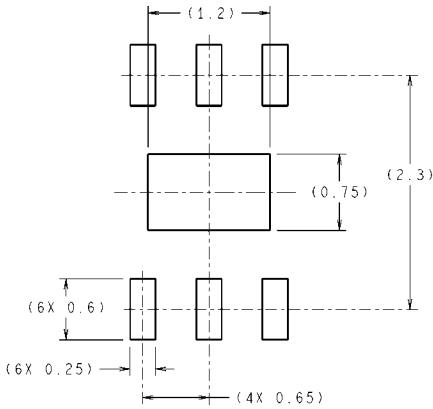
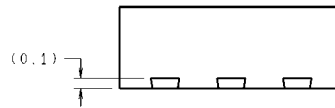

FIGURE 34. Equalized Signal (Zoom) (10m 24AWG PCIe Cable, 5Gbps, PRBS7)

Physical Dimensions inches (millimeters) unless otherwise noted



DIMENSIONS ARE IN MILLIMETERS
DIMENSIONS IN () FOR REFERENCE ONLY



RECOMMENDED LAND PATTERN

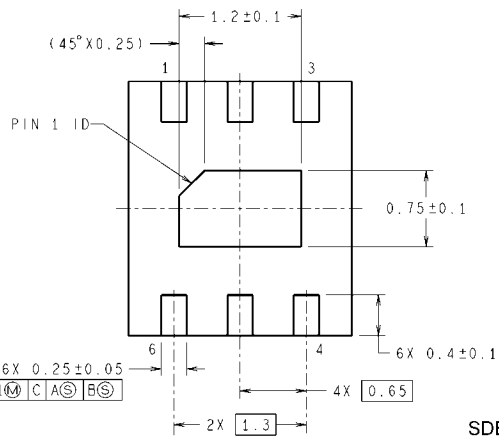
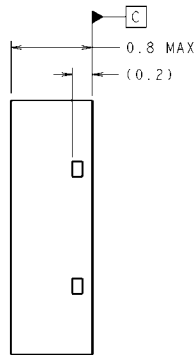
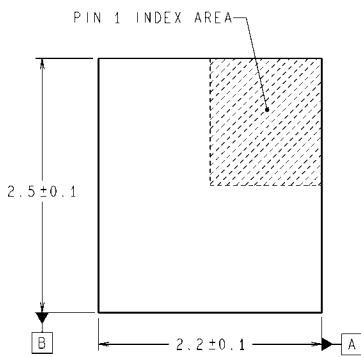

SDB06A (Rev A)

Order number DS38EP100
See NS Package SDB06A

Notes

THE CONTENTS OF THIS DOCUMENT ARE PROVIDED IN CONNECTION WITH NATIONAL SEMICONDUCTOR CORPORATION ("NATIONAL") PRODUCTS. NATIONAL MAKES NO REPRESENTATIONS OR WARRANTIES WITH RESPECT TO THE ACCURACY OR COMPLETENESS OF THE CONTENTS OF THIS PUBLICATION AND RESERVES THE RIGHT TO MAKE CHANGES TO SPECIFICATIONS AND PRODUCT DESCRIPTIONS AT ANY TIME WITHOUT NOTICE. NO LICENSE, WHETHER EXPRESS, IMPLIED, ARISING BY ESTOPPEL OR OTHERWISE, TO ANY INTELLECTUAL PROPERTY RIGHTS IS GRANTED BY THIS DOCUMENT.

TESTING AND OTHER QUALITY CONTROLS ARE USED TO THE EXTENT NATIONAL DEEMS NECESSARY TO SUPPORT NATIONAL'S PRODUCT WARRANTY. EXCEPT WHERE MANDATED BY GOVERNMENT REQUIREMENTS, TESTING OF ALL PARAMETERS OF EACH PRODUCT IS NOT NECESSARILY PERFORMED. NATIONAL ASSUMES NO LIABILITY FOR APPLICATIONS ASSISTANCE OR BUYER PRODUCT DESIGN. BUYERS ARE RESPONSIBLE FOR THEIR PRODUCTS AND APPLICATIONS USING NATIONAL COMPONENTS. PRIOR TO USING OR DISTRIBUTING ANY PRODUCTS THAT INCLUDE NATIONAL COMPONENTS, BUYERS SHOULD PROVIDE ADEQUATE DESIGN, TESTING AND OPERATING SAFEGUARDS.

EXCEPT AS PROVIDED IN NATIONAL'S TERMS AND CONDITIONS OF SALE FOR SUCH PRODUCTS, NATIONAL ASSUMES NO LIABILITY WHATSOEVER, AND NATIONAL DISCLAIMS ANY EXPRESS OR IMPLIED WARRANTY RELATING TO THE SALE AND/OR USE OF NATIONAL PRODUCTS INCLUDING LIABILITY OR WARRANTIES RELATING TO FITNESS FOR A PARTICULAR PURPOSE, MERCHANTABILITY, OR INFRINGEMENT OF ANY PATENT, COPYRIGHT OR OTHER INTELLECTUAL PROPERTY RIGHT.

LIFE SUPPORT POLICY

NATIONAL'S PRODUCTS ARE NOT AUTHORIZED FOR USE AS CRITICAL COMPONENTS IN LIFE SUPPORT DEVICES OR SYSTEMS WITHOUT THE EXPRESS PRIOR WRITTEN APPROVAL OF THE CHIEF EXECUTIVE OFFICER AND GENERAL COUNSEL OF NATIONAL SEMICONDUCTOR CORPORATION. As used herein:

Life support devices or systems are devices which (a) are intended for surgical implant into the body, or (b) support or sustain life and whose failure to perform when properly used in accordance with instructions for use provided in the labeling can be reasonably expected to result in a significant injury to the user. A critical component is any component in a life support device or system whose failure to perform can be reasonably expected to cause the failure of the life support device or system or to affect its safety or effectiveness.

National Semiconductor and the National Semiconductor logo are registered trademarks of National Semiconductor Corporation. All other brand or product names may be trademarks or registered trademarks of their respective holders.

Copyright© 2007 National Semiconductor Corporation

For the most current product information visit us at www.national.com



National Semiconductor Americas Customer Support Center
 Email: new.feedback@nsc.com
 Tel: 1-800-272-9959

National Semiconductor Europe Customer Support Center
 Fax: +49 (0) 180-530-85-86
 Email: europe.support@nsc.com
 Deutsch Tel: +49 (0) 69 9508 6208
 English Tel: +49 (0) 870 24 0 2171
 Français Tel: +33 (0) 1 41 91 8790

National Semiconductor Asia Pacific Customer Support Center
 Email: ap.support@nsc.com

National Semiconductor Japan Customer Support Center
 Fax: 81-3-5639-7507
 Email: jpn.feedback@nsc.com
 Tel: 81-3-5639-7560