

## 30V, 200mA Low Dropout Voltage Linear Regulator

### General Description

The DS8304 series are a group of low-dropout ( LDO ) voltage regulators offering the benefits of wide input voltage range, low dropout voltage, low power consumption, and miniaturized packaging.

Quiescent current of only 2.2 $\mu$ A makes these devices ideal for powering the battery-powered, always-on systems that require very little idle-state power dissipation to a longer service life.

The DS8304 series of linear regulators are stable with the ceramic output capacitor over its wide input range from 2V to 30V and the entire range of output load current ( 0mA to 200mA ).

### Features

- 2.2 $\mu$ A Ground Current at no Load
- $\pm$ 2% Output Accuracy
- 200mA Output Current
- Wide Operating Input Voltage Range: 2V to 30V
- Dropout Voltage: 0.15V at 100mA /  $V_{OUT}$  5V
- Support Fixed Output Voltage 1.2V, 1.8V, 3.3V, 5V, 9V, 12V
- Stable with Ceramic or Tantalum Capacitor
- Current Limit Protection
- Over-Temperature Protection
- SOT-23-3, SOT-23-5, SOT-89-3 Packages Available

### Applications

- Portable, Battery Powered Equipment
- Low Power Microcontrollers
- Laptop, Palmtops and PDAs
- Wireless Communication Equipment
- Audio/Video Equipment
- Car Navigation Systems
- Industrial Controls
- Weighting Scales
- Meters
- Home Automation

### Pin Configurations

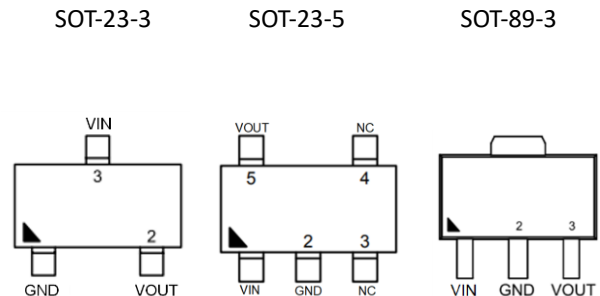

## Ordering Information

DS8304-**AA****BB**

Designator	Description	Symbol	Description
<b>AA</b>	Output Voltage	<b>12</b>	$V_{OUT} = 1.2V$
		<b>..</b>	..
		<b>..</b>	..
		<b>99</b>	$V_{OUT} = 9.9V$
		<b>A1</b>	$V_{OUT} = 12V$
<b>BB</b>	Package type	<b>S3</b>	SOT-23-3
		<b>S5</b>	SOT-23-5
		<b>A3</b>	SOT-89-3

Special Request: Any Voltage between 1.2V and 12V under specific business agreement

## Description of Functional Pins

Pin No			Pin Name	Pin Function
SOT-23-3	SOT-23-5	SOT-89-3		
1	2	2	GND	Ground
2	5	3	VOUT	Output of the Regulator
3	1	1	VIN	Input of Supply Voltage.
	3,4		NC	No Internal Connection.

**Typical Application Circuits**

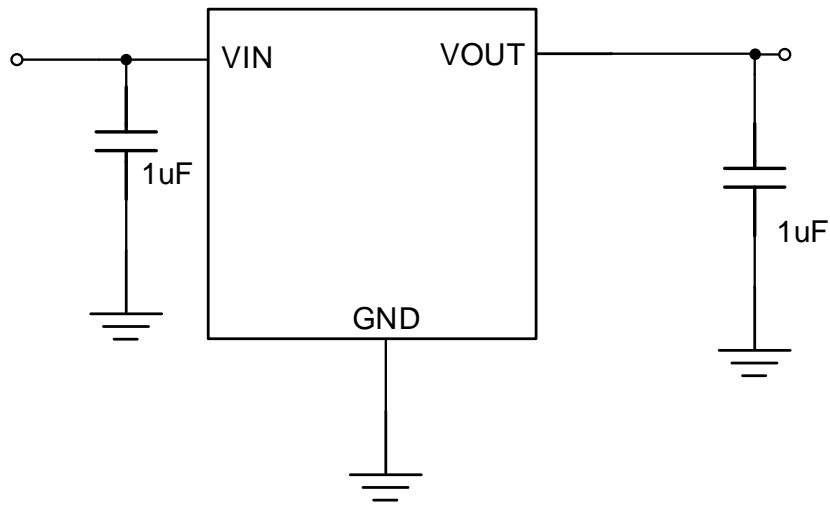
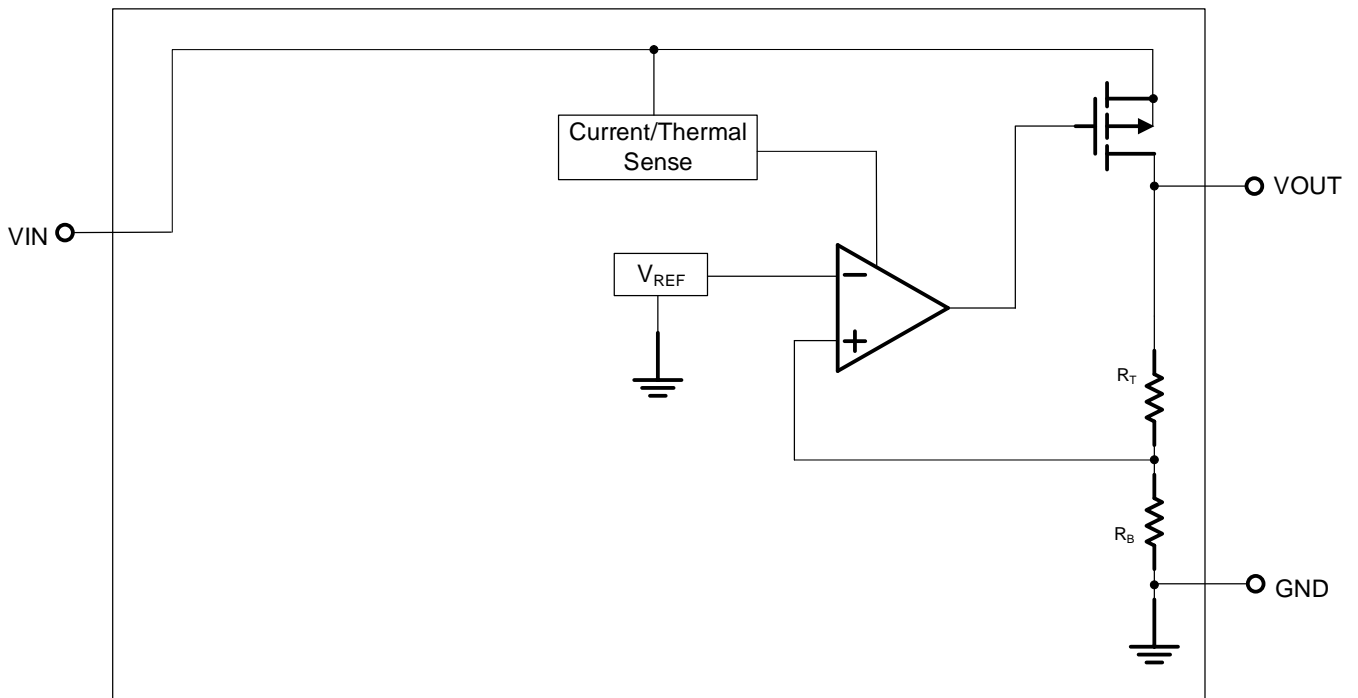

Figure 1: Application circuit of Fixed  $V_{OUT}$  LDO

**Function Block Diagram**



**Absolute Maximum Ratings** (Note 1)

VIN to GND	-----	-0.3V to 36V
VOUT to GND		
DS8304-A1, DS8304-90	-----	-0.3V to 14.0V
DS8304-18, DS8304-33, DS8304-50	-----	-0.3V to 6.0V
VOUT to VIN	-----	-36V to 0.3V
Package Thermal Resistance (Note 2)		
SOT-23-5, SOT-23-3, $\theta_{JA}$	-----	200 °C /W
SOT-89-3, $\theta_{JA}$	-----	120 °C /W
Lead Temperature (Soldering, 10 sec.)	-----	260 °C
Junction Temperature	-----	150 °C
Storage Temperature Range	-----	-60 °C to 150 °C
ESD Susceptibility		
HBM	-----	2KV
MM	-----	200V

**Recommended Operating Conditions**

Input Voltage VIN	-----	2.0V to 30V
Junction Temperature Range	-----	-40 °C to 125 °C
Ambient Temperature Range	-----	-40 °C to 85 °C

## Electrical Characteristics

( $V_{IN} = 15V$ ,  $V_{EN} = 5V$ ,  $T_A = 25^\circ C$  unless otherwise specified)

Parameter	Symbol	Test Conditions	Min	Typ	Max	Unit
Supply Voltage	$V_{IN}$		2	--	30	V
DC Output Voltage Accuracy		$I_{LOAD} = 0.1mA$	-2		2	%
Dropout Voltage ( $I_{LOAD} = 100mA$ )	$V_{DROP}$	$V_{OUT} \geq 5V$	--	0.15		V
	$V_{DROP\_3.3V}$	$V_{OUT} = 3.3V$		0.15		
	$V_{DROP\_1.8V}$	$V_{OUT} = 1.8V$		0.25		
Dropout Voltage ( $I_{LOAD} = 200mA$ )	$V_{DROP\_1.8V}$	$V_{OUT} = 1.8V$		0.47		V
Ground Current ( $I_{LOAD} = 0mA$ )	$I_Q$	$V_{OUT} \leq 5V$		2.2		$\mu A$
	$I_{QH}$	$5V < V_{OUT} \leq 12V$		4.2		
Line Regulation	$\Delta LINE$	$I_{LOAD} = 1mA$ , $5 \leq V_{IN} \leq 30V$	--	0.3		%
Load Regulation	$\Delta LOAD$	$1mA \leq I_{LOAD} \leq 0.2A$		0.1		%
Output Current Limit	$I_{LIM}$	$V_{OUT} = 0$	201	400		mA
Power Supply Rejection Ratio	PSRR	$V_{OUT} = 5V$ , $I_{LOAD} = 1mA$ , $V_{IN} = 12V$ , $f = 100Hz$		70		dB
Thermal Shutdown Temperature	$T_{SD}$	$I_{LOAD} = 10mA$	--	160	--	$^\circ C$
Thermal Shutdown Hysteresis	$\Delta T_{SD}$		15			$^\circ C$

**Note 1.** Stresses beyond those listed “Absolute Maximum Ratings” may cause permanent damage to the device. These are stress ratings only, and functional operation of the device at these or any other conditions beyond those indicated in the operational sections of the specifications is not implied. Exposure to absolute maximum rating conditions may affect device reliability.

**Note 2.**  $\theta_{JA}$  is measured at  $T_A = 25^\circ C$  on a DS-Tech EVB board.

## Typical Characteristics

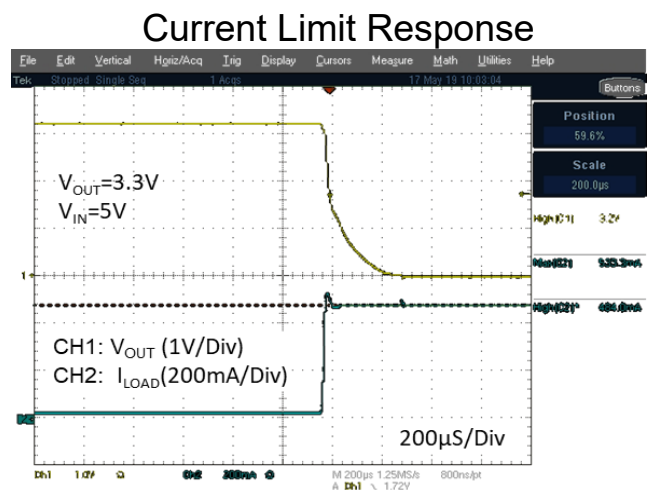
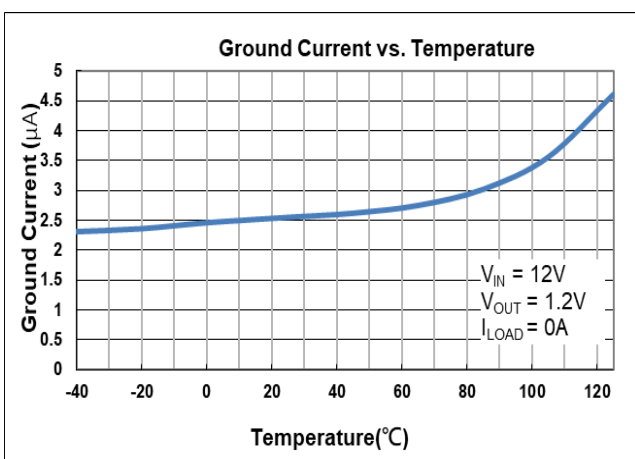
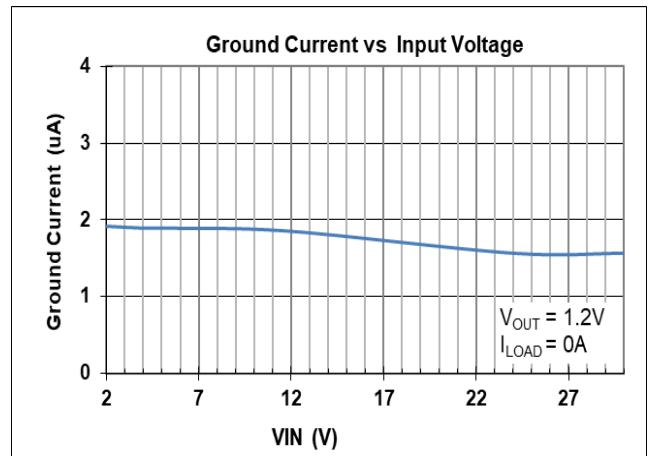
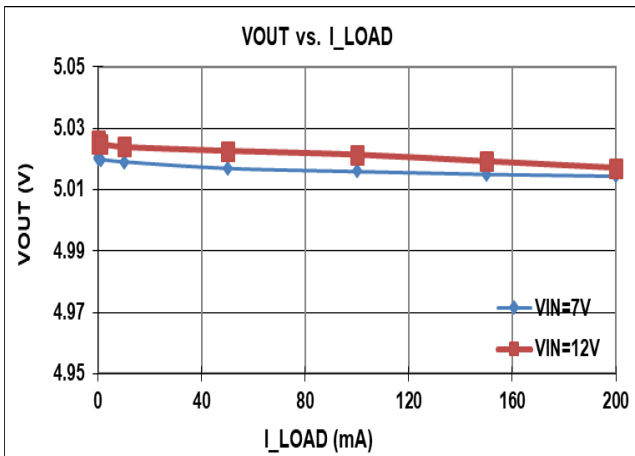
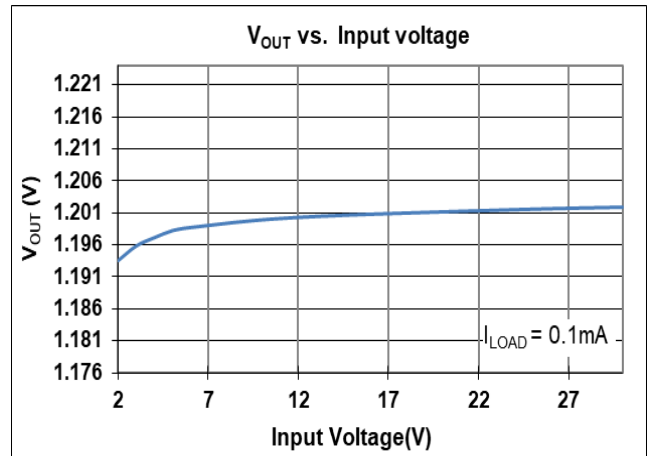
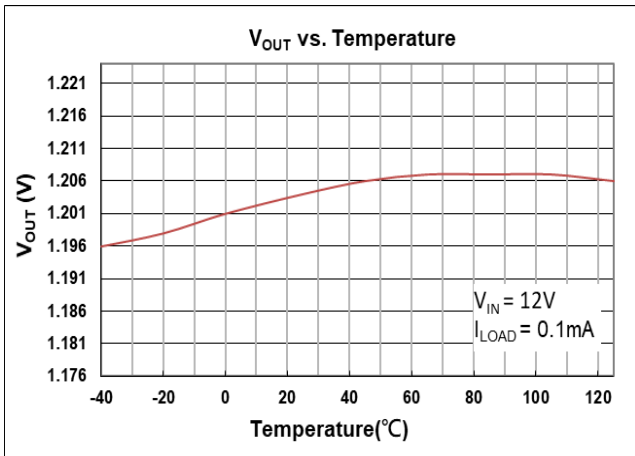

Load Transient Response

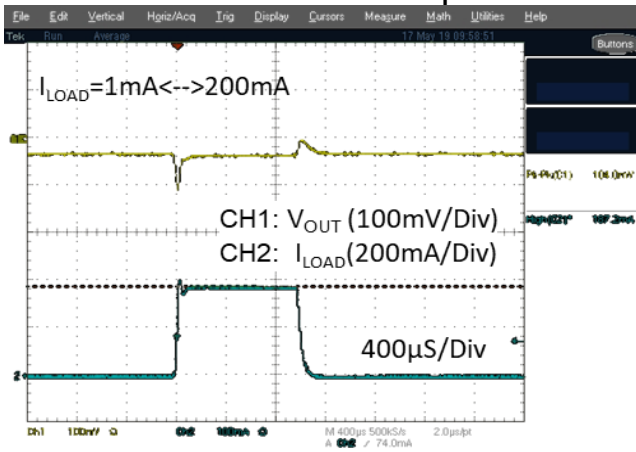

Line Transient Response

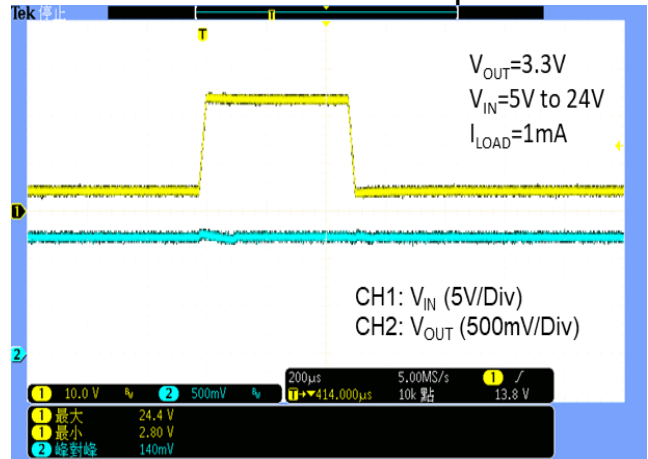

$V_{OUT}$  Turn on by  $V_{IN}$  Quick Power Up

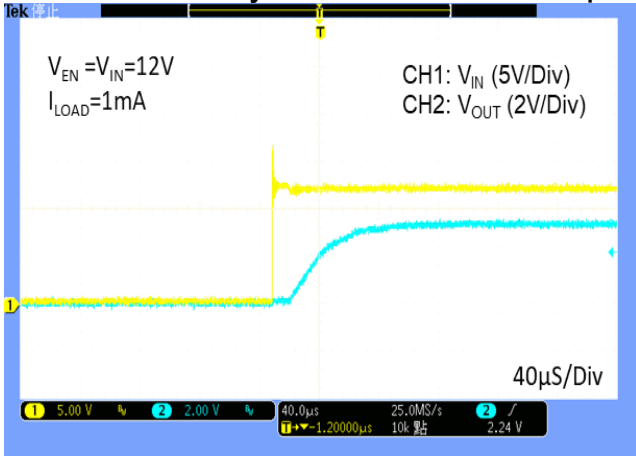

**Application Guideline****Input and Output Capacitor Requirements**

The external input and output capacitors of DS8304 series must be properly selected for stability and performance. Use a 1 $\mu$ F or larger input capacitor and place it close to the IC's VIN and GND pins. Any output capacitor meeting the minimum 1m $\Omega$  ESR ( Equivalent Series Resistance ) and effective capacitance between 1 $\mu$ F and 22 $\mu$ F requirement may be used. Place the output capacitor close to the IC's VOUT and GND pins. Increasing capacitance and decreasing ESR can improve the circuit's PSRR and line transient response.

**Current Limit**

The DS8304 series contain the current limiter of output power transistor, which monitors and controls the transistor, limiting the output current to 300mA ( typical ). The output can be shorted to ground indefinitely without damaging the part.

**Dropout Voltage**

The DS8304 series use a PMOS pass transistor to achieve low dropout. When ( VIN – VOUT ) is less than the dropout voltage ( V<sub>DROP</sub> ), the PMOS pass device is in the linear region of operation and the input-to-output resistance is the R<sub>DS(ON)</sub> of the PMOS pass element. V<sub>DROP</sub> scales approximately with the output current because the PMOS device behaves as a resistor in dropout condition.

**Layout Consideration**

By placing input and output capacitors on the same side of the PCB as the LDO, and placing them as close as is practical to the package can achieve the best performance. The ground connections for input and output capacitors must be back to the DS8304 ground pin using as wide and as short of a copper trace as is practical.

Connections using long trace lengths, narrow trace widths, and/or connections through via must be avoided. These add parasitic inductances and resistance that results in worse performance especially during transient conditions.

As any linear regulator, PSRR and transient response are degraded as ( VIN – VOUT ) approaches dropout condition.

**OTP (Over Temperature Protection)**

The over temperature protection function of DS8304 series will turn off the P-MOSFET when the junction temperature exceeds 160°C (typ.). Once the junction temperature cools down by approximately 15°C, the regulator will automatically resume operation.

**Thermal Application**

For continuous operation, do not exceed the absolute maximum junction temperature. The maximum power dissipation depends on the thermal resistance of the IC package, PCB layout, rate of surrounding airflow, and difference between junction and ambient temperature. The maximum power dissipation can be calculated as below:

T<sub>A</sub>=25°C, DS-Tech PCB,

The max PD (Max)= (125°C – 25°C) / (200°C/W) = 0.5W for SOT-23-3/SOT-23-5 packages.

The max PD (Max)= (125°C – 25°C) / (120°C/W) = 0.83W for SOT-89-3 package

Power dissipation (PD) is equal to the product of the output current and the voltage drop across the output pass element, as shown in the equation below:

$$PD = (VIN - VOUT) \times IOUT$$



**Package Information:**

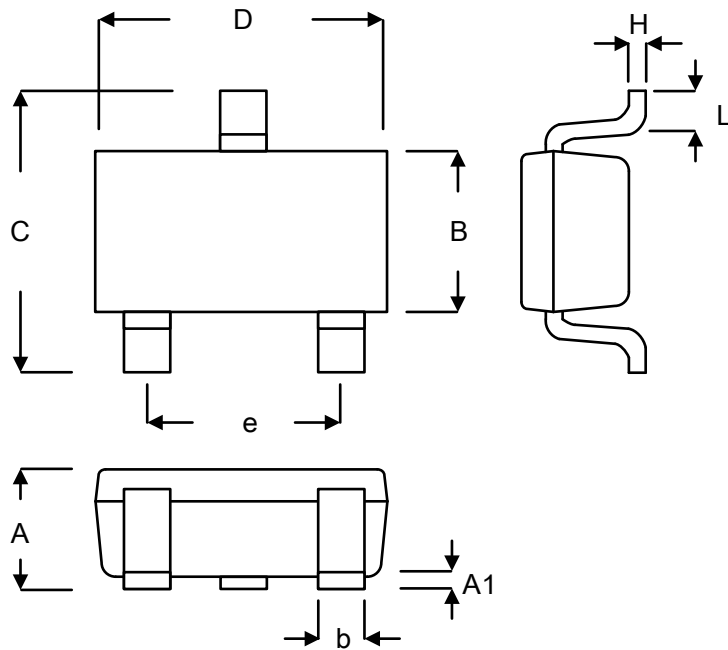

Symbol	Millimeters		Inches	
	Min.	Max.	Min.	Max.
A	0.889	1.295	0.035	0.051
A1	0.000	0.152	0.000	0.006
B	1.397	1.803	0.055	0.071
b	0.250	0.560	0.010	0.022
C	2.591	2.997	0.102	0.118
D	2.692	3.099	0.106	0.122
e	1.803	2.007	0.071	0.079
H	0.080	0.254	0.003	0.010
L	0.300	0.610	0.012	0.024

SOT-23-3L

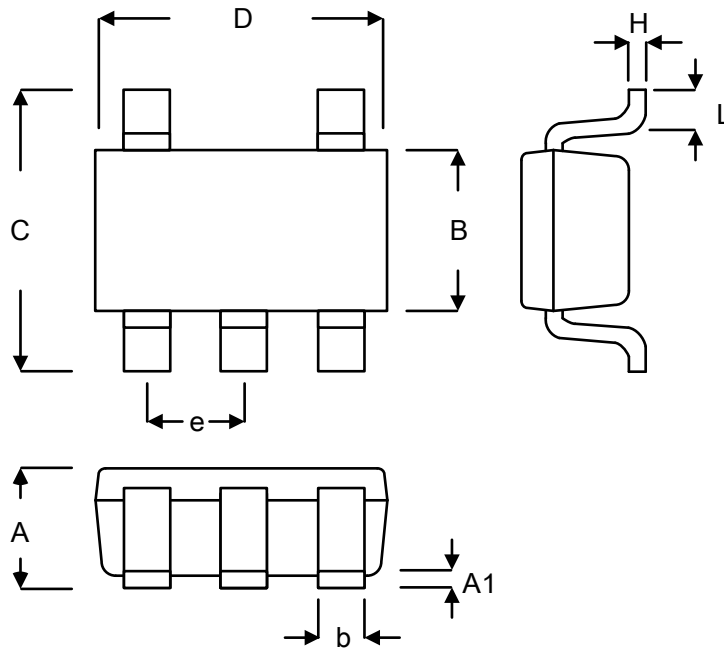

Symbol	Millimeters		Inches	
	Min.	Max.	Min.	Max.
A	0.889	1.295	0.035	0.051
A1	0.000	0.152	0.000	0.006
B	1.397	1.803	0.055	0.071
b	0.250	0.560	0.010	0.022
C	2.591	2.997	0.102	0.118
D	2.692	3.099	0.106	0.122
e	0.838	1.041	0.033	0.041
H	0.080	0.254	0.003	0.010
L	0.300	0.610	0.012	0.024

SOT-23-5L

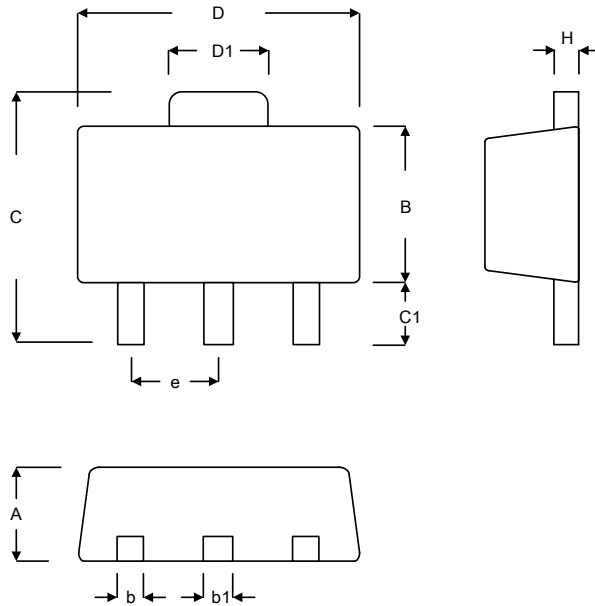

Symbol	Millimeters		Inches	
	Min.	Max.	Min.	Max.
A	1.397	1.600	0.055	0.063
b	0.356	0.483	0.014	0.019
B	2.388	2.591	0.094	0.102
b1	0.406	0.533	0.016	0.021
C	3.937	4.242	0.155	0.167
C1	0.787	1.194	0.031	0.047
D	4.394	4.597	0.173	0.181
D1	1.397	1.753	0.055	0.069
e	1.448	1.549	0.057	0.061
H	0.356	0.432	0.014	0.017

SOT-89-3L