

DS8615/DS8616 130/225 MHz Low Power Dual Modulus Prescalers

General Description

The DS8615 series products are low power dual modulus prescalers which divide by 32/33 and 40/41 respectively. The modulus control (MC) input selects division by N when at a high TTL level and division by N + 1 when at a low TTL level. The clock inputs are buffered, providing 40/100 mVrms input sensitivity. The two outputs provide the user the option to wire either a totem-pole or open-collector output structure. Additionally, the user can wire a resistor between the two output pins to minimize edge transition emissions. The outputs are designed to drive positive edge triggered PLLs. These products can be operated from either an unregulated 5.5V to 13.5V source or regulated 5V \pm 10% source. Unregulated operation is obtained by connecting V_S to the source with V_{REG} open. Regulated operation is obtained by connecting both V_S and V_{REG} to the supply source.

The device can be used in phase-locked loop applications such as FM radio or other communications bands to pre-scale the input frequency down to a more usable level. A digital frequency display system can also be derived separately or in conjunction with a phase-locked loop, and it can extend the useful range of many inexpensive frequency counters to 225 MHz.

Features

- Input frequency: 130 MHz (-4); 225 MHz (-2)
- Low power: 10 mA (-4, -2)
- Input sensitivity: 100 mVrms (-4); 40 mVrms (-2)
- Pin compatible with Motorola MC12015-16 prescalers
- Unregulated/regulated power supply option

Logic and Connection Diagrams

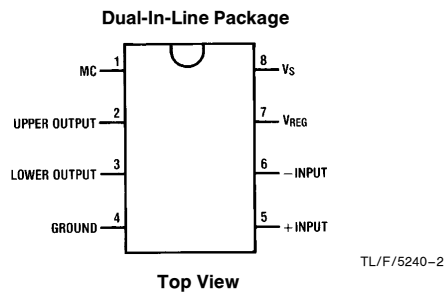
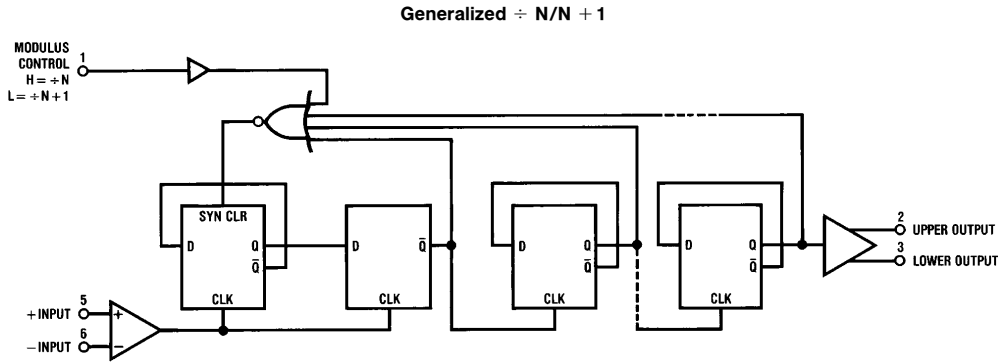

Order Number DS8615N or DS8616N (-4, -2)
See NS Package Number N08E

DS8615/DS8616 130/225 MHz Low Power Dual Modulus Prescalers

Absolute Maximum Ratings (Note 1)

If Military/Aerospace specified devices are required, please contact the National Semiconductor Sales Office/Distributors for availability and specifications.

V_S , Unregulated Supply Voltage 15V
 V_{REG} , Regulated Supply Voltage 7V

Modulus Control Input Voltage 7V
 Open-Collector Output Voltage 7V
 Operating Free Air Temperature Range -30°C to $+70^{\circ}\text{C}$
 Storage Temperature Range -65°C to $+150^{\circ}\text{C}$

Recommended Operating Conditions

Symbol	Parameter	Conditions	DS8615-4 DS8616-4		DS8615-2 DS8616-2		Units
			Min	Max	Min	Max	
V_S	Unregulated Supply Voltage	$V_{REG} = \text{Open}$	6.8	13.5	5.5	13.5	V
V_{REG}	Regulated Supply Voltage	V_S and V_{REG} Shorted	4.5	5.5	4.5	5.5	V
f_{MAX}	Toggle Frequency	$V_{IN} = 100 \text{ mVrms}$	20	130		225	MHz
V_{IN}	Input Signal Amplitude		100	300	40	300	mVrms
V_{SLW}	Slew Rate		20		20		V/ μs
I_{OH}	High Level Output Current			-400		-400	μA
I_{OL}	Low Level Output Current			2.0		2.0	mA

DC Electrical Characteristics (Notes 2 and 3)

Symbol	Parameter	Conditions	DS8615-4 DS8616-4		DS8615-2 DS8616-2		Units
			Min	Max	Min	Max	
V_{IH}	High Level MC Input Voltage	$V_S = 13.5\text{V}$, $V_{REG} = \text{Open}$	2.0		2.0		V
V_{IL}	Low Level MC Input Voltage	$V_{REG} = V_S = 4.5\text{V}$		0.8		0.8	V
V_{OH}	High Level Output Voltage	$I_{OH} = -0.4 \text{ mA}$, Pins 2 and 3 Shorted	$V_{REG} - 2$		$V_{REG} - 2$		V
I_{CEX}	Open-Collector High Level Output	Lower Output = 5.5V		100		100	μA
V_{OL}	Low Level Output Voltage	$V_{REG} = 4.5\text{V}$, $I_{OL} = 2 \text{ mA}$		0.5		0.5	V
I_I	Max MC Input Current	$V_S = 13.5\text{V}$, $V_{REG} = \text{Open}$, $V_{IH} = 7\text{V}$		100		100	μA
I_{IH}	High Level MC Input Current	$V_{REG} = 4.5\text{V}$, $V_{IH} = 2.7\text{V}$		20		20	μA
I_{IL}	Low Level MC Input Current	$V_S = 13.5\text{V}$, $V_{REG} = \text{Open}$, $V_{IL} = 0.4\text{V}$		-200		-200	μA
I_S	Supply Current, Unregulated Mode	$V_S = 13.5\text{V}$, $V_{REG} = \text{Open}$		10		10	mA
I_{REG}	Supply Current, Regulated Mode	$V_S = V_{REG} = 5.5\text{V}$		10		10	mA

Note 1: "Absolute Maximum Ratings" are those values beyond which the safety of the device cannot be guaranteed. They are not meant to imply that the device should be operated at these limits. The table of "Electrical Characteristics" provides conditions for actual device operation.

Note 2: Unless otherwise specified Min/Max limits apply across the -30°C to $+70^{\circ}\text{C}$ range.

Note 3: All current into device pins shown as positive, out of device pins as negative, all voltages referenced to ground unless otherwise noted. All values shown as Max or Min on absolute value basis.

AC Electrical Characteristics $V_{CC} = 5V \pm 10\%$, $T_A = -30^\circ\text{C}$ to $+70^\circ\text{C}$

Symbol	Parameter	Conditions	Min	Max	Units
t_{MODULUS}	Modulus Set-Up Time (Notes 4 and 5)	DS8615, DS8616		65	ns
R_{IN}	AC Input Resistance	$V_{\text{IN}} = 100\text{ MHz}$ and 50 mVrms	1.0		$k\Omega$
C_{IN}	Input Capacitance	$V_{\text{IN}} = 100\text{ MHz}$ and 50 mVrms	3	10	pF

Note 1: "Absolute Maximum Ratings" are those values beyond which the safety of the device cannot be guaranteed. Except for "Operating Temperature Range" they are not meant to imply that the devices should be operated at these limits. The table of "Electrical Characteristics" provides conditions for actual device operation.

Note 2: Unless otherwise specified min/max limits apply across the -30°C to $+70^\circ\text{C}$ temperature range.

Note 3: All currents into device pins are shown as positive, out of device pins as negative, all voltages referenced to ground unless otherwise noted. All values shown as max or min on absolute value basis.

Note 4: t_{MODULUS} = the period of time the modulus control level must be defined prior to the positive transition of the prescaler output to ensure proper modulus selection.

Note 5: See Timing Diagrams.

Timing Diagram

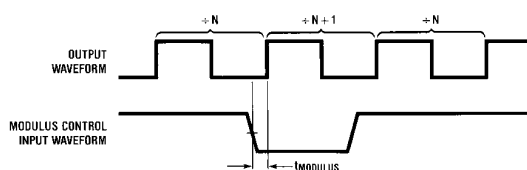

TL/F/5240-3

The logical state of the modulus control input just prior to the output's rising edge will determine the modulus ratio of the device immediately following that rising edge. The pulse width difference of N and $N + 1$ operation occurs during the output = HI conditions.

Typical Applications

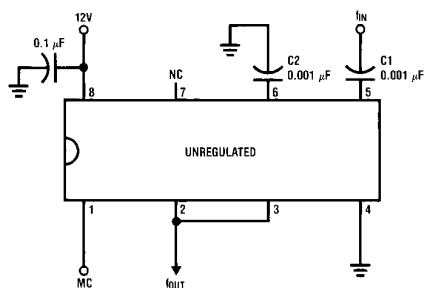

TL/F/5240-4

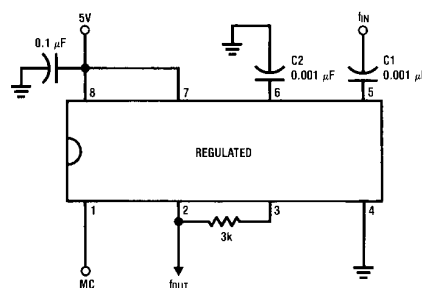

TL/F/5240-5

Schematic Diagrams

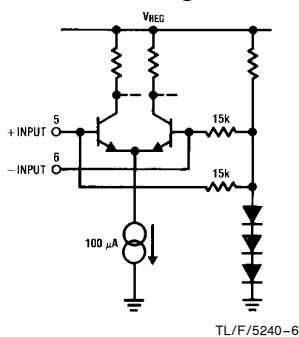

TL/F/5240-6

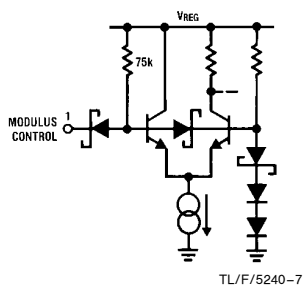

TL/F/5240-7

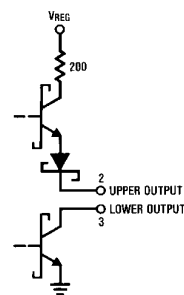

TL/F/5240-8

Application Hints

OPERATING NOTES

The signal source is usually capacitively coupled to the input. At higher frequencies a 0.001 μF input capacitor (C1) is usually sufficient, with larger values used at the lower frequencies. If the input signal is likely to be interrupted, it may be desirable to connect a 100 k Ω resistor between one input and ground to stabilize the device. In the single-ended mode, it is preferable to connect the resistor to the unused input. In the differential mode, the resistor can be connected to either input. The addition of the 100 k Ω pulldown resistor causes a loss of input sensitivity, but prevents circuit oscillations under no signal (open circuit) conditions. In addition, in

the single ended mode, a capacitor of 0.001 μF (C2) should be connected between the unused input and the ground plane to provide a good high frequency bypass. The capacitor should be made larger for lower frequencies.

The input waveform may be sinusoidal, but below about 20 MHz the operation of the circuit becomes dependent on the slew rate of the input rather than amplitude. A square wave input with a slew rate of greater than 20 V/ μs will permit correct operation down to lower frequencies, provided the proper input coupling capacitor is provided.

For regulated mode operation connect V_S to V_{REG} to ensure proper operation (see Typical Application diagram).

Physical Dimensions inches (millimeters)

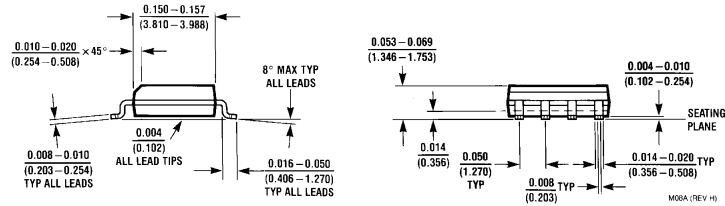
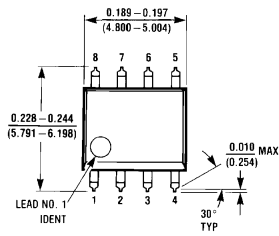

Molded Dual-In-Line Package (M)
Order Number DS8614M-4, DS8615M-4, DS8616M-4 or DS8617M-4
NS Package Number M08A

Physical Dimensions inches (millimeters) (Continued)

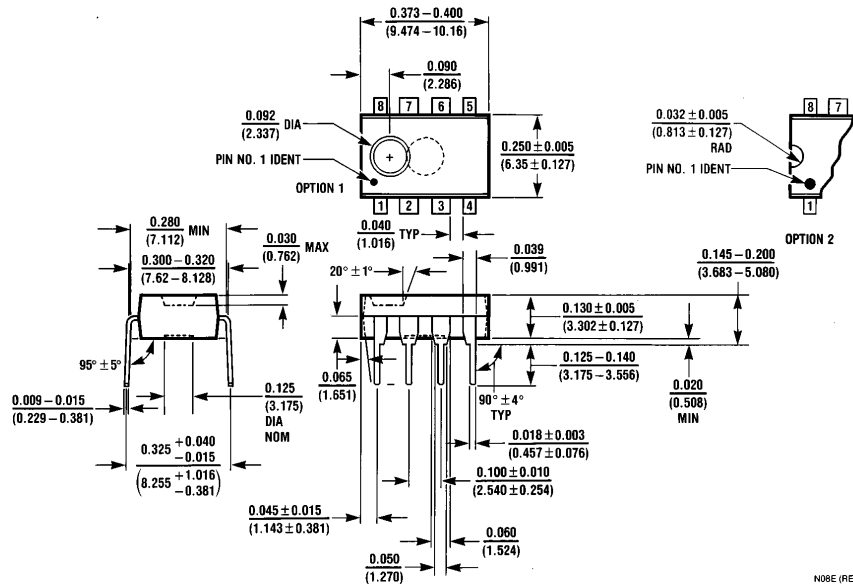

Molded Dual-In-Line Package (N)
Order Number DS8614N, DS8615N, DS8616N or DS8617N (-4, -3, -2)
NS Package Number N08E

N08E (REV F)

LIFE SUPPORT POLICY

NATIONAL'S PRODUCTS ARE NOT AUTHORIZED FOR USE AS CRITICAL COMPONENTS IN LIFE SUPPORT DEVICES OR SYSTEMS WITHOUT THE EXPRESS WRITTEN APPROVAL OF THE PRESIDENT OF NATIONAL SEMICONDUCTOR CORPORATION. As used herein:

1. Life support devices or systems are devices or systems which, (a) are intended for surgical implant into the body, or (b) support or sustain life, and whose failure to perform, when properly used in accordance with instructions for use provided in the labeling, can be reasonably expected to result in a significant injury to the user.
2. A critical component is any component of a life support device or system whose failure to perform can be reasonably expected to cause the failure of the life support device or system, or to affect its safety or effectiveness.



National Semiconductor Corporation
 1111 West Bardin Road
 Arlington, TX 76017
 Tel: 1(800) 272-9959
 Fax: 1(800) 737-7018

National Semiconductor Europe
 Fax: (+49) 0-180-530 85 86
 Email: cnjwge@tevm2.nsc.com
 Deutsch Tel: (+49) 0-180-530 85 85
 English Tel: (+49) 0-180-532 78 32
 Français Tel: (+49) 0-180-532 93 58
 Italiano Tel: (+49) 0-180-534 16 80

National Semiconductor Hong Kong Ltd.
 19th Floor, Straight Block,
 Ocean Centre, 5 Canton Rd.
 Tsimshatsui, Kowloon
 Hong Kong
 Tel: (852) 2737-1600
 Fax: (852) 2736-9960

National Semiconductor Japan Ltd.
 Tel: 81-043-299-2309
 Fax: 81-043-299-2408

National does not assume any responsibility for use of any circuitry described, no circuit patent licenses are implied and National reserves the right at any time without notice to change said circuitry and specifications.

This datasheet has been download from:

www.datasheetcatalog.com

Datasheets for electronics components.