

DS8925 LocalTalk™ Dual Driver/Triple Receiver

General Description

The DS8925 is a dual driver/triple receiver device optimized to provide a single chip solution for a LocalTalk Interface. The device provides one differential TIA/EIA-422 driver, one TIA/EIA-423 single ended driver, one TIA/EIA-422 receiver and two TIA/EIA-423 receivers, all in a surface mount 16 pin package. This device is electrically similar to the 26LS30 and 26LS32 devices.

The drivers feature $\pm 10V$ common mode range, and the differential driver provides TRI-STATEable outputs. The receivers offer ± 200 mV thresholds over the $\pm 10V$ common mode range.

Features

- Single chip solution for LocalTalk port
- Two driver/three receivers per package
- Wide common mode range: $\pm 10V$
- ± 200 mV receiver sensitivity
- 70 mV typical receiver input hysteresis
- Available in SOIC packaging

Connection Diagram

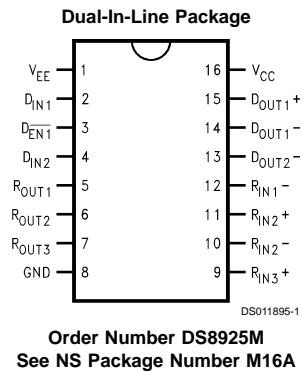

Functional Diagram

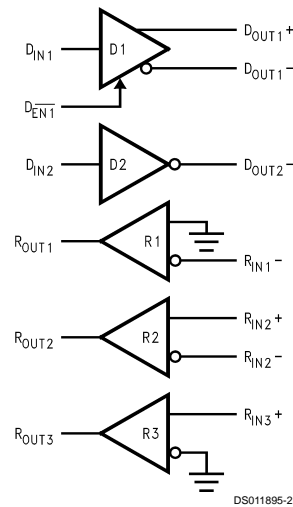

Absolute Maximum Ratings (Note 1)

If Military/Aerospace specified devices are required, please contact the National Semiconductor Sales Office/Distributors for availability and specifications.

| | |
|---|-------|
| Supply Voltage (V_{CC}) | +7V |
| Supply Voltage (V_{EE}) | -7V |
| Enable Input Voltage (D_{EN1}) | +7V |
| Driver Input Voltage (D_{IN}) | +7V |
| Driver Output Voltage (Power Off: D_{OUT}) | ±15V |
| Receiver Input Voltage (V_{ID} : $R_{IN+} - R_{IN-}$) | ±25V |
| Receiver Input Voltage (V_{CM} : $(R_{IN+} + R_{IN-})/2$) | ±25V |
| Receiver Input Voltage (Input to GND: R_{IN}) | ±25V |
| Receiver Output Voltage (R_{OUT}) | +5.5V |
| Maximum Package Power Dissipation @+25°C M Package | 1.33W |

Derate M Package 10.6 mW/°C above +25°C

Storage Temperature Range -65°C to +150°C

Lead Temperature Range (Soldering, 4 Sec.) +260°C

This Device Does Not Meet 2000V

ESD Rating (Note 7)

Recommended Operating Conditions

| | Min | Typ | Max | Units |
|--|-------|------|-------|-------|
| Supply Voltage (V_{CC}) | +4.75 | +5.0 | +5.25 | V |
| Supply Voltage (V_{EE}) | -4.75 | -5.0 | -5.25 | V |
| Operating Free Air Temperature (T_A) | 0 | 25 | 70 | °C |

Electrical Characteristics (Notes 2, 3)

Over Supply Voltage and Operating Temperature ranges, unless otherwise specified

| Symbol | Parameter | Conditions | Pin | Min | Typ | Max | Units | |
|--|--|---|--|--------------|-------|------|-------|----|
| DIFFERENTIAL DRIVER CHARACTERISTICS | | | | | | | | |
| V_{OD} | Output Differential Voltage | $R_L = \infty$ or $R_L = 3.9\text{ k}\Omega$ | D _{OUT+} , D _{OUT-} | ±7 | ±9.0 | ±10 | V | |
| V_O | Output Voltage | $R_L = \infty$ or $R_L = 3.9\text{ k}\Omega$ | | ±4.5 | ±5.25 | V | | |
| V_{OD1} | Output Differential Voltage | $R_L = 100\Omega$, Figure 1 | | 4.0 | 6.4 | V | | |
| V_{SS} | $ V_{OD1} - V_{OD1+} $ | | | 8.0 | 12.8 | V | | |
| ΔV_{OD1} | Output Unbalance | | | | 0.02 | 0.4 | V | |
| V_{OS} | Offset Voltage | | | | 0 | 3 | V | |
| ΔV_{OS} | Offset Unbalance | | | | 0.05 | 0.4 | V | |
| V_{OD2} | Output Differential Voltage | $R_L = 140\Omega$, Figure 1 | | 6.0 | 7.0 | V | | |
| I_{OZD} | TRI-STATE® Leakage Current | $V_{CC} = 5.25V$ $V_{EE} = -5.25V$ | | $V_O = +10V$ | | 2 | 150 | µA |
| | | | | $V_O = +6V$ | | 1 | 100 | µA |
| | | | $V_O = -6V$ | | -1 | -100 | µA | |
| | | | $V_O = -10V$ | | -2 | -150 | µA | |
| SINGLE ENDED DRIVER CHARACTERISTICS | | | | | | | | |
| V_O | Output Voltage (No Load) | $R_L = \infty$ or $R_L = 3.9\text{ k}\Omega$, Figure 2 | D _{OUT-} | 4 | 4.4 | 6 | V | |
| V_T | Output Voltage | $R_L = 3\text{ k}\Omega$, Figure 2 | | 3.7 | 4.3 | V | | |
| | | $R_L = 450\Omega$, Figure 2 | | 3.6 | 4.1 | V | | |
| ΔV_T | Output Unbalance | | | | 0.02 | 0.4 | V | |
| DRIVER CHARACTERISTICS | | | | | | | | |
| V_{CM} | Common Mode Range | Power Off, or D1 Disabled | D _{OUT+} , D _{OUT-} | ±10 | | | V | |
| I_{OSD} | Short Circuit Current | $V_O = 0V$, Sourcing Current | | | -80 | -150 | mA | |
| | | $V_O = 0V$, Sinking Current | | | 80 | 150 | mA | |
| I_{OXD} | Power-Off Leakage Current ($V_{CC} = V_{EE} = 0V$) | $V_O = +10V$ | | | 2 | 150 | µA | |
| | | $V_O = +6V$ | | | 1 | 100 | µA | |
| | | $V_O = -6V$ | | | -1 | -100 | µA | |
| | | $V_O = -10V$ | | | -2 | -150 | µA | |

Electrical Characteristics (Notes 2, 3) (Continued)

Over Supply Voltage and Operating Temperature ranges, unless otherwise specified

| Symbol | Parameter | Conditions | Pin | Min | Typ | Max | Units | |
|---------------------------------|--|---|--------------------------|------|-----|-------|-------|----|
| RECEIVER CHARACTERISTICS | | | | | | | | |
| V_{TH} | Input Threshold | $-7V \leq V_{CM} \leq +7V$ | R_{IN+} , R_{IN-} | -200 | ±35 | +200 | mV | |
| V_{HY} | Hysteresis | $V_{CM} = 0V$ | | | | 70 | | mV |
| R_{IN} | Input Resistance | $-10V \leq V_{CM} \leq +10V$ | | | 6.0 | 8.5 | | kΩ |
| I_{IN} | Input Current (Other Input = 0V, Power On, or $V_{CC} = V_{EE} = 0V$) | $V_{IN} = +10V$ | | | | | 3.25 | mA |
| | | $V_{IN} = +3V$ | | | 0 | | 1.50 | mA |
| | | $V_{IN} = -3V$ | | | 0 | | -1.50 | mA |
| | | $V_{IN} = -10V$ | | | | -3.25 | mA | |
| V_{IB} | Input Balance Test | $R_S = 500\Omega$ (R2 only) | | | | ±400 | mV | |
| V_{OH} | High Level Output Voltage | $I_{OH} = -400 \mu A$, $V_{IN} = +200$ mV | R_{OUT} | 2.7 | 4.2 | | V | |
| | | $I_{OH} = -400 \mu A$, $V_{IN} = OPEN$ | | 2.7 | 4.2 | | V | |
| V_{OL} | Low Level Output Voltage | $I_{OL} = 8.0$ mA, $V_{IN} = -200$ mV | | | | 0.3 | 0.5 | V |
| I_{OSR} | Short Circuit Current | $V_O = 0V$ | | -15 | -34 | -85 | mA | |
| DEVICE CHARACTERISTICS | | | | | | | | |
| V_{IH} | High Level Input Voltage | | D_{IN+} , D_{EN1} | 2.0 | | | V | |
| V_{IL} | Low Level Input Voltage | | | | | | 0.8 | V |
| I_{IH} | High Level Input Current | $V_{IN} = 2.4V$ | | | | 1 | 40 | μA |
| I_{IL} | Low Level Input Current | $V_{IN} = 0.4V$ | | | | -10 | -200 | μA |
| V_{CL} | Input Clamp Voltage | $I_{IN} = -12$ mA | | | | | -1.5 | V |
| I_{CC} | Power Supply Current | No Load | V_{CC} | | 40 | 65 | mA | |
| I_{EE} | | D1 Enabled or Disabled | V_{EE} | | -5 | -15 | mA | |

Switching Characteristics (Notes 4, 5)

Over Supply Voltage and Operating Temperature Ranges, unless otherwise specified

| Symbol | Parameter | Conditions | Min | Typ | Max | Units |
|--|--|--|-----|-----|-----|-------|
| DIFFERENTIAL DRIVER CHARACTERISTICS | | | | | | |
| t_{PHLD} | Differential Propagation Delay High to Low | $R_L = 100\Omega, C_L = 500\text{ pF}$, (Figures 3, 4) $C_1 = C_2 = 50\text{ pF}$ | 70 | 134 | 350 | ns |
| t_{PLHD} | Differential Propagation Delay Low to High | | 70 | 141 | 350 | ns |
| t_{SKD} | Differential Skew $ t_{PHLD} - t_{PLHD} $ | | | 7 | 50 | ns |
| t_r | Rise Time | | 50 | 140 | 300 | ns |
| t_f | Fall Time | | 50 | 140 | 300 | ns |
| t_{PHZ} | Disable Time High to Z | $R_L = 100\Omega, C_L = 500\text{ pF}$ (Figures 7, 8) | | 300 | 600 | ns |
| t_{PLZ} | Disable Time Low to Z | | | 300 | 600 | ns |
| t_{PZH} | Enable Time Z to High | | | 160 | 350 | ns |
| t_{PZL} | Enable Time Z to Low | | | 160 | 350 | ns |
| SINGLE ENDED DRIVER CHARACTERISTICS | | | | | | |
| t_{PHL} | Propagation Delay High to Low | $R_L = 450\Omega, C_L = 500\text{ pF}$ (Figures 5, 6) | 70 | 120 | 350 | ns |
| t_{PLH} | Propagation Delay Low to High | | 70 | 150 | 350 | ns |
| t_{SK} | Skew, $ t_{PHL} - t_{PLH} $ | | | 30 | 70 | ns |
| t_r | Rise Time | | 50 | 100 | 300 | ns |
| t_f | Fall Time | | 20 | 50 | 300 | ns |
| RECEIVER CHARACTERISTICS | | | | | | |
| t_{PHL} | Propagation Delay High to Low | $C_L = 15\text{ pF}$ (Figures 9, 10) | 10 | 33 | 75 | ns |
| t_{PLH} | Propagation Delay Low to High | | 10 | 30 | 75 | ns |
| t_{SK} | Skew, $ t_{PHL} - t_{PLH} $ | | | 3 | 20 | ns |

Note 1: Absolute Maximum Ratings are those values beyond which the safety of the device cannot be guaranteed. They are not meant to imply that the devices should be operated at these limits. The table of Electrical Characteristics specifies conditions of device operation.

Note 2: Current into device pins is defined as positive. Current out of device pins is defined as negative. All voltages are referenced to ground except V_{OD} , V_{OD1} , V_{OD2} , and V_{SS} .

Note 3: All typicals are given for: $V_{CC} = +5.0V$, $V_{EE} = -5.0V$, $T_A = +25^\circ C$ unless otherwise specified.

Truth Tables

Driver (D1)

| Inputs | | Outputs | |
|----------------------|-----------|-------------|-------------|
| $\overline{D_{EN1}}$ | D_{IN1} | D_{OUT1+} | D_{OUT1-} |
| H | X | Z | Z |
| L | L | L | H |
| L | H | H | L |

Driver (D2)

| Input | Output |
|-----------|-------------|
| D_{IN2} | D_{OUT2-} |
| L | H |
| H | L |

H = Logic High Level (Steady State)
L = Logic Low Level (Steady State)
X = Irrelevant (Any Input)
Z = Off State (TRI-STATE, High Impedance)
† OPEN = Non-Terminated

Receiver (1)

| Input | Output |
|-----------------------|------------|
| R_{IN1-} | R_{OUT1} |
| $\leq -200\text{ mV}$ | H |
| $\geq +200\text{ mV}$ | L |
| OPEN† | H |

Receiver (2)

| Inputs | Output |
|-----------------------|------------|
| $R_{IN2+} - R_{IN2-}$ | R_{OUT2} |
| $\leq -200\text{ mV}$ | L |
| $\geq +200\text{ mV}$ | H |
| OPEN† | H |

Receiver (3)

| Input | Output |
|-----------------------|------------|
| R_{IN3+} | R_{OUT3} |
| $\leq -200\text{ mV}$ | L |
| $\geq +200\text{ mV}$ | H |
| OPEN† | H |

Parameter Measurement Information

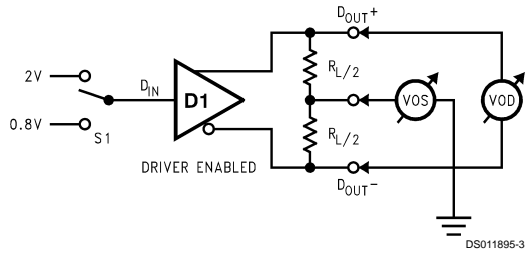

FIGURE 1. Differential Driver DC Test Circuit

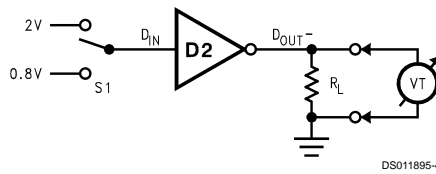

FIGURE 2. Single Ended Driver DC Test Circuit

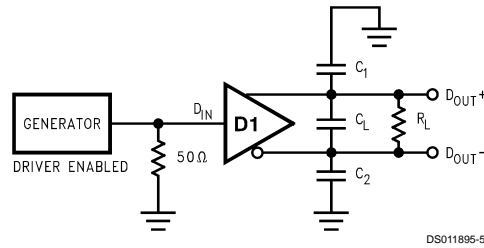

FIGURE 3. Differential Driver Propagation Delay and Transition Time Test Circuit

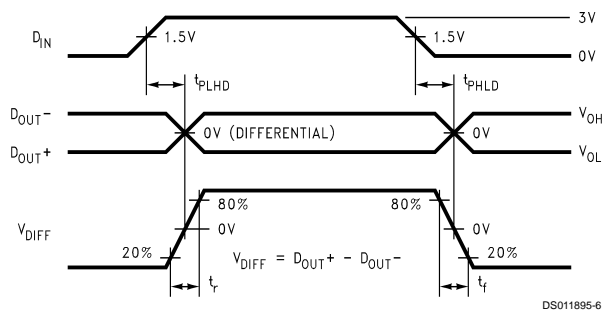

FIGURE 4. Differential Driver Propagation Delay and Transition Time Waveforms

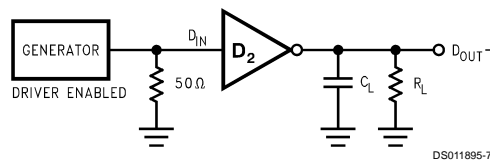

FIGURE 5. Single Ended Driver Propagation Delay and Transition Time Test Circuit

Parameter Measurement Information (Continued)

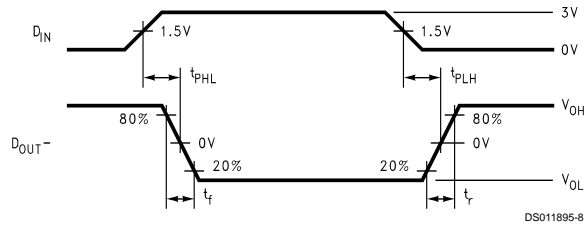

FIGURE 6. Single Ended Driver Propagation Delay and Transition Time Waveform

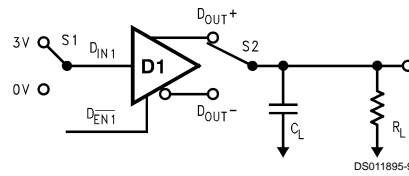

FIGURE 7. Differential Driver TRI-STATE Test Circuit

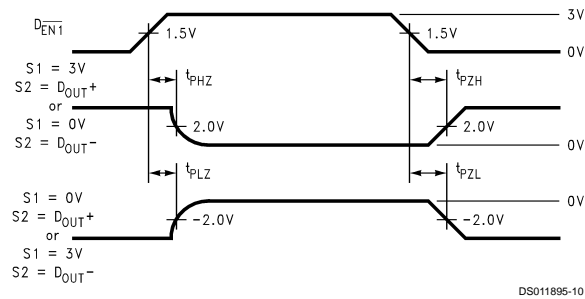

FIGURE 8. Differential Driver TRI-STATE Waveforms

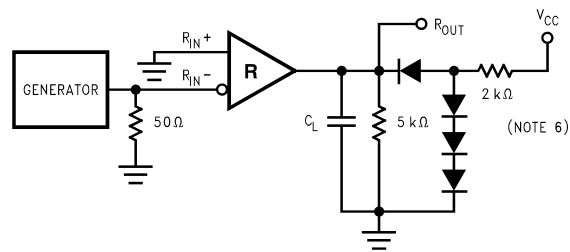
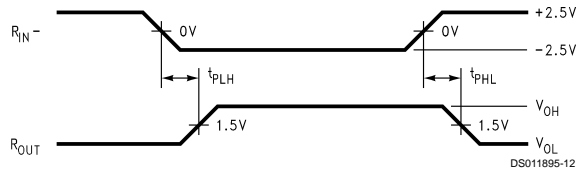

FIGURE 9. Receiver Propagation Delay Test Circuit

Parameter Measurement Information (Continued)



Note 4: Generator waveform for all tests unless otherwise specified: $f = 500 \text{ kHz}$, $Z_O = 50\Omega$, $t_r \leq 10 \text{ ns}$, $t_f \leq 10 \text{ ns}$.

Note 5: C_L includes probe and jig capacitance.

Note 6: All diodes are 1N916 or equivalent.

Note 7: ESD Rating HBM (1.5 k Ω , 100 pF) pins 10, 12 $\geq 1500\text{V}$, all other pins $\geq 2000\text{V}$.

FIGURE 10. Receiver Propagation Delay Waveform

Typical Application Information

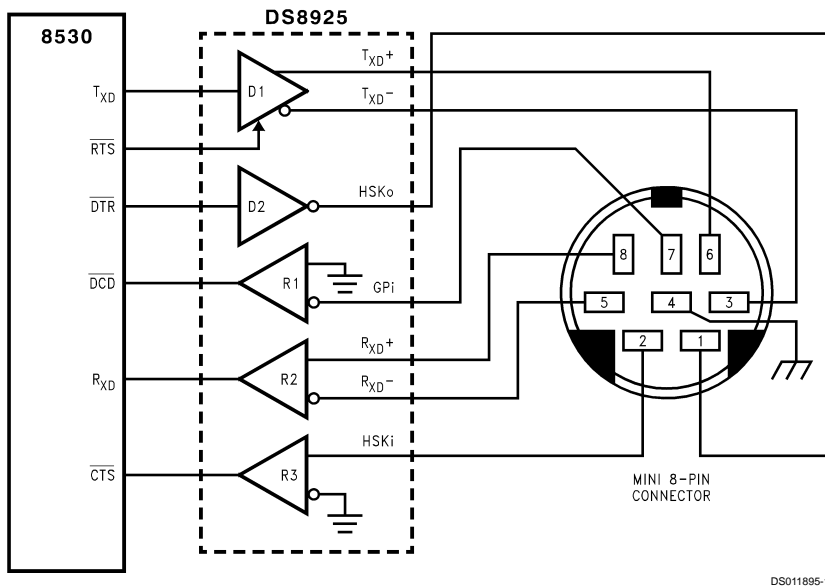

FIGURE 11. Typical LocalTalk Application

TABLE 1. Device Pin Descriptions

| Pin# | Name | Description |
|---------|----------------------|--|
| 2, 4 | D_{IN} | TTL Driver Input Pins |
| 3 | $\overline{D_{EN1}}$ | Active Low Driver Enable Pin. A High on this Pin TRI-STATES the Driver Outputs (D1 Only) |
| 15 | D_{OUT+} | Non-Inverting Driver Output Pin |
| 13, 14 | D_{OUT-} | Inverting Driver Output Pin |
| 9, 11 | R_{IN+} | Non-Inverting Receiver Input Pin |
| 10, 12 | R_{IN-} | Inverting Receiver Input Pin |
| 5, 6, 7 | R_{OUT} | Receiver Output Pin |
| 8 | GND | Ground Pin |
| 1 | V_{EE} | Negative Power Supply Pin, $-5\text{V} \pm 5\%$ |
| 16 | V_{CC} | Positive Power Supply Pin, $+5\text{V} \pm 5\%$ |

Typical Application Information

(Continued)

DRIVER OUTPUT WAVEFORMS

The driver configuration on the DS8925 is unique among TIA/EIA-422 devices in that it utilizes $-5V$ V_{EE} supply. A typical TIA/EIA-422 driver uses $+5V$ only and generates signal swings of approximately $0V$ – $5V$.

By utilizing V_{EE} , the differential driver is able to generate a much larger differential signal. The typical output voltage is about $|4|$ V, which gives $|8|$ V differentially, thus providing a much greater noise margin than $+5V$ drivers. See Figure 12. The receiver therefore has a range of $+8V$ to $-8V$ or V_{SS} of $16V$ ($V_{SS} = V_{OD} - V_{OD}^*$).

Each side of the differential driver operates similar to a TIA/EIA-423 driver. The output voltages are slightly different due to the loading: the differential driver has differential termination, the single-ended driver is terminated with a resistor to ground.

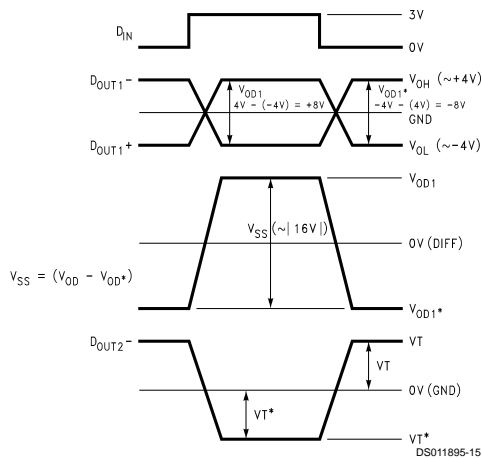

Note 8: Star (*) represents the opposite input condition for a parameter.

FIGURE 12. Typical Driver Output Waveforms

UNUSED PINS

Unused driver outputs should be left open. If tied to either ground or supply, the driver may enter an I_{OS} state and consume excessive power. Unused driver inputs should not be

left floating as this may lead to unwanted switching which may affect I_{CC} , particularly the frequency component. Unused driver inputs should be tied to ground.

Receiver outputs will be in a HIGH state when inputs are open; therefore, outputs should not be tied to ground. It is best to leave unused receiver outputs floating.

RECEIVER FAILSAFE

All three receivers on this device incorporate open input fail-safe protection. The differential receiver output will be in a HIGH state when inputs are open, but will be indetermined if inputs are shorted together. Unused differential inputs should be left floating.

Both single-ended receivers (inverting and non-inverting) are biased internally so that an open input will result in a HIGH output. Therefore, these inputs should not be shorted to ground when unused.

BYPASS CAPACITORS

Bypass capacitors are recommended for both V_{CC} and V_{EE} . Noise induced on the supply lines can affect the signal quality of the output; V_{CC} affects the V_{OH} and V_{EE} affects the V_{OL} . Capacitors help reduce the effect on signal quality. A value of $0.1 \mu F$ is typically used.

Since this is a power device, it is recommended to use a bypass capacitor for each supply and for each device. Sharing a bypass capacitor between other devices may not be sufficient.

TERMINATION

On a multi-point transmission line which is electrically long, it is advisable to terminate the line at both ends with its characteristic impedance to prevent signal reflection and its associated noise/crosstalk.

A 100Ω termination resistor is commonly specified by TIA/EIA-422 for differential signals. The DS8925 is also specified using 140Ω termination which will result in less power associated with the driver output. The additional resistance is typical of applications requiring EMI filtering on the driver outputs.

TWO-WIRE LocalTalk

The DS8925 is a single chip solution for a LocalTalk interface. A typical application is shown in Figure 11.

An alternative implementation of LocalTalk is to only use two wires to communicate. The differential data lines can be transformer-coupled on to a twisted pair medium. See Figure 13. The handshake function must then be accomplished in software.

Typical Application Information (Continued)

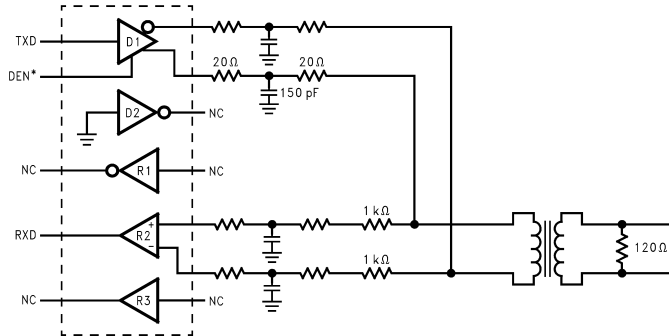

Note 9: Star (*) represents the opposite input condition for a parameter.

FIGURE 13. Differential Communication, Transformer-Coupled to a Twisted-Pair Line

SINGLE +5V SUPPLY

The DS8925 is derived from the DS3691/92 which could be configured using a single +5V supply ($V_{EE} = 0V$). This device is not specified for this type of operation. However, the device will not be damaged if operated using a single +5V supply.

Both drivers require the -5V supply in order to meet the output voltage levels specified. When the device switches from a positive voltage to the complimentary state, it is pulled toward the V_{EE} level. If that level is 0V, then the complimentary

state will be near 0V instead of V_{EE} . Thus, the output would switch from about 4V to 0V, instead of 4V to -4V. The differential driver will meet TIA/EIA-422, but with a reduced noise margin. The single-ended driver will not meet TIA/EIA-423 without the -5V supply.

The receivers will be functional but may suffer parametrically. The inverting receiver is referenced to V_{EE} therefore, the threshold may shift slightly. The inputs can still vary over the $\pm 10V$ common mode range.

Typical Performance Characteristics (Note 10)

Differential Driver Output Voltage vs Output Current

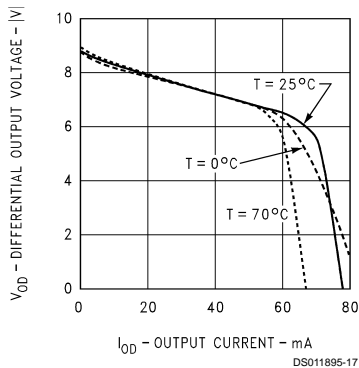

Differential Driver Output Voltage vs Output Current

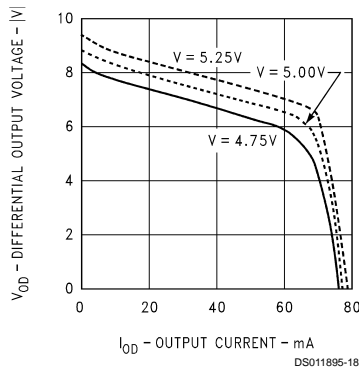

Typical Performance Characteristics (Note 10) (Continued)

Differential Driver Propagation Delay vs Temperature

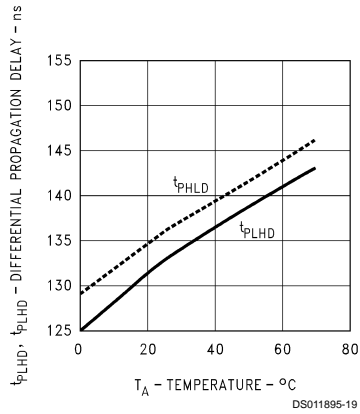

Differential Driver Propagation Delay vs Power Supply Voltage

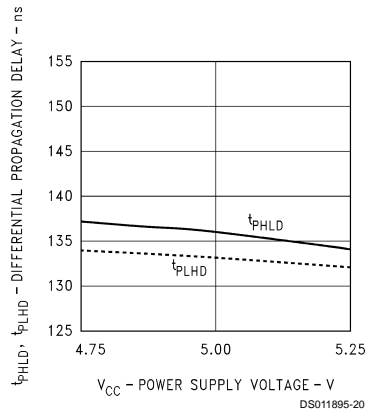

Differential Driver Skew vs Temperature

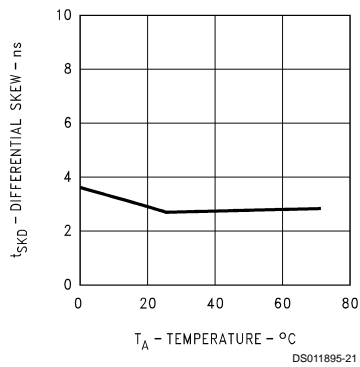

Differential Driver Skew vs Power Supply Voltage

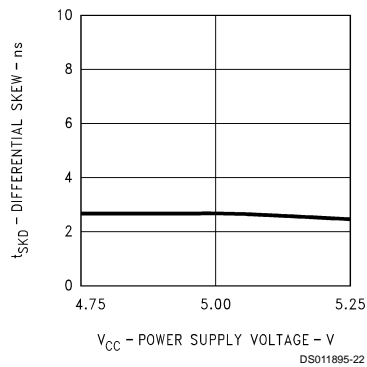

Differential Transition Time vs Temperature

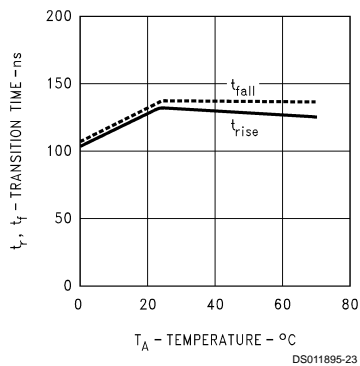

Differential Transition Time vs Power Supply Voltage

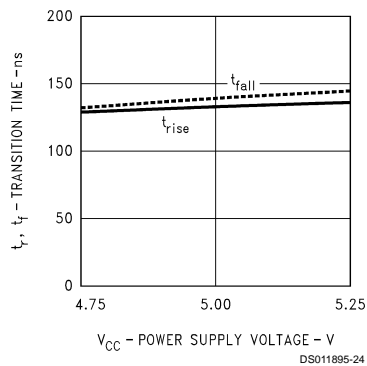

Typical Performance Characteristics (Note 10) (Continued)

Driver Output High Voltage vs Output High Current

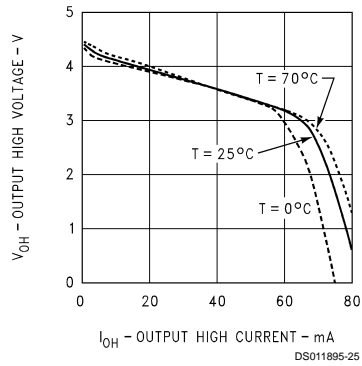

Driver Output High Voltage vs Output High Current

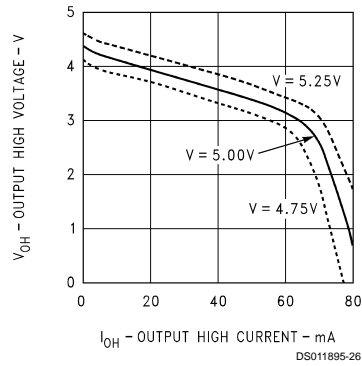

Driver Output Low Voltage vs Output Low Current

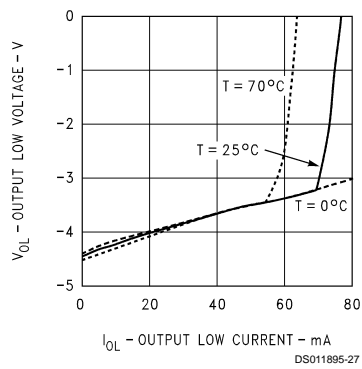

Driver Output Low Voltage vs Output Low Current

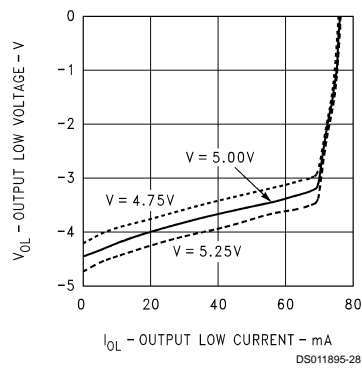

Driver Propagation Delay vs Temperature

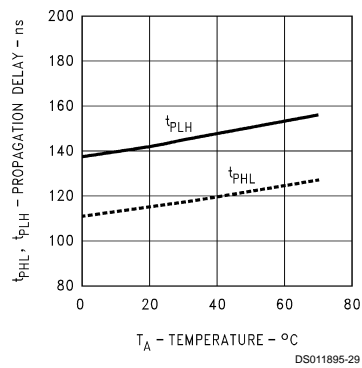

Driver Propagation Delay vs Power Supply Voltage

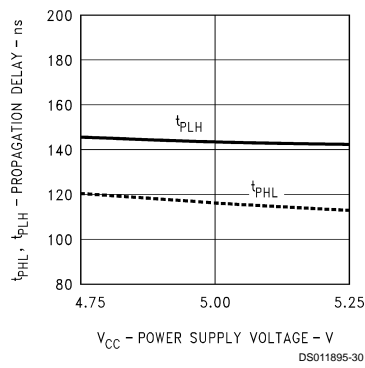

Typical Performance Characteristics (Note 10) (Continued)

Driver Skew vs Temperature

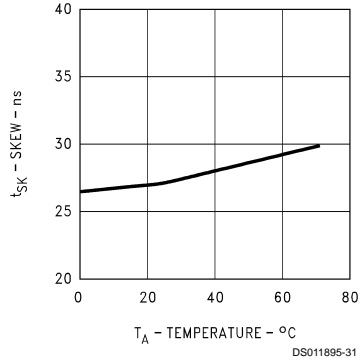

Driver Skew vs Power Supply Voltage

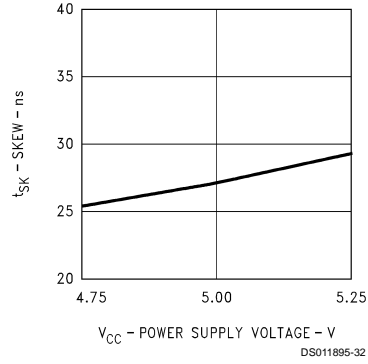

Driver Transition Time vs Temperature

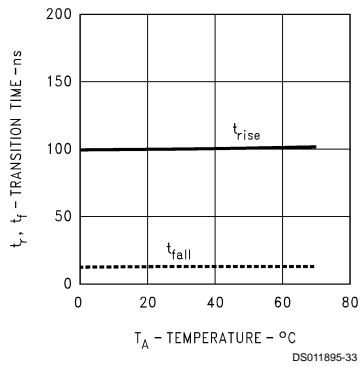

Driver Transition Time vs Power Supply Voltage

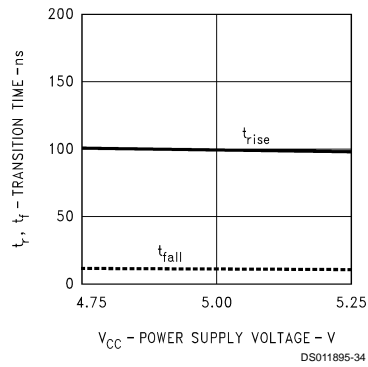

Receiver Output High Voltage vs Output High Current

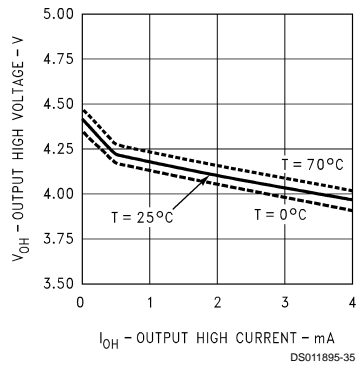

Receiver Output High Voltage vs Output High Current

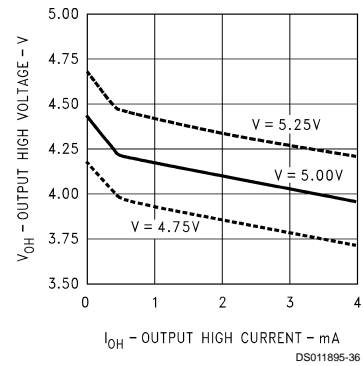

Typical Performance Characteristics (Note 10) (Continued)

Receiver Output Low Voltage vs Output Low Current

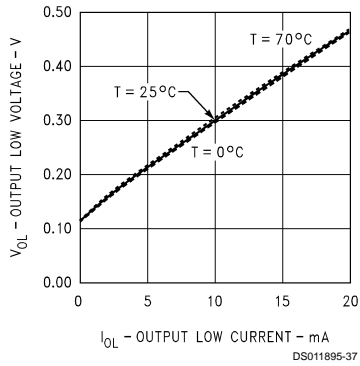

Receiver Output Low Voltage vs Output Low Current

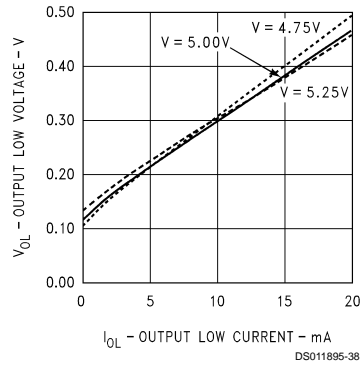

Receiver Input Current vs Input Voltage (Power On)

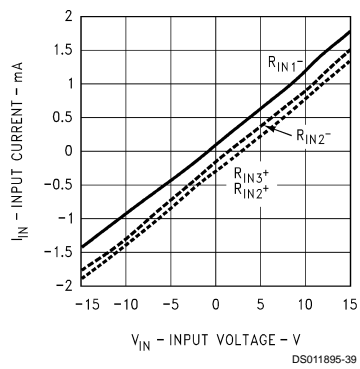

Receiver Input Current vs Input Voltage (Power Off)

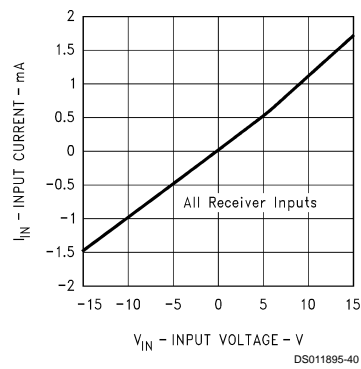

Receiver Output Propagation Delay vs Temperature

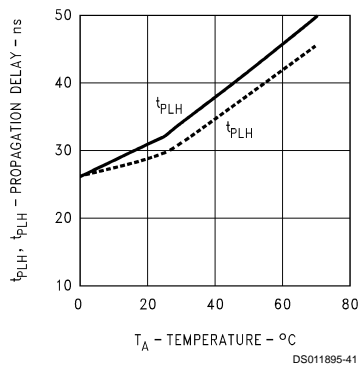

Receiver Output Propagation Delay vs Power Supply Voltage

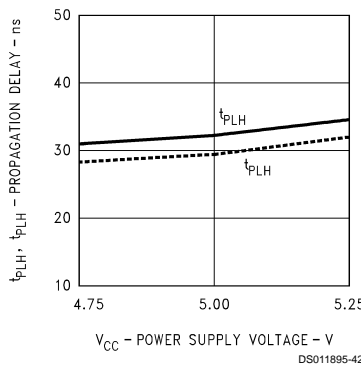

Typical Performance Characteristics (Note 10) (Continued)

Receiver Output Skew vs Temperature

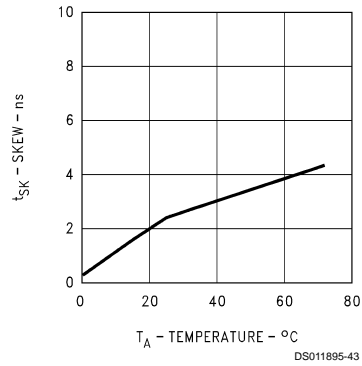

Receiver Output Skew vs Power Supply Voltage

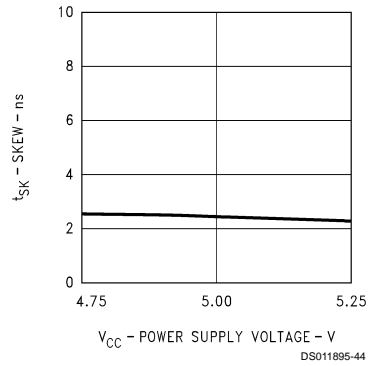

Supply Current vs Power Supply Voltage

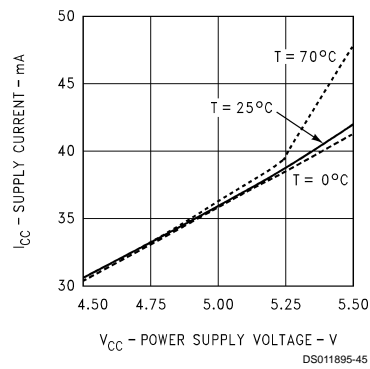

Supply Current vs Power Supply Voltage

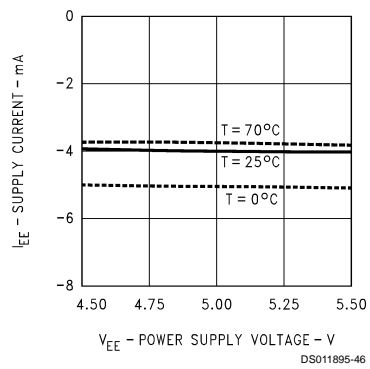

Note 10: V defined as $V_{CC} = |V_{EE}|$



Physical Dimensions inches (millimeters) unless otherwise noted

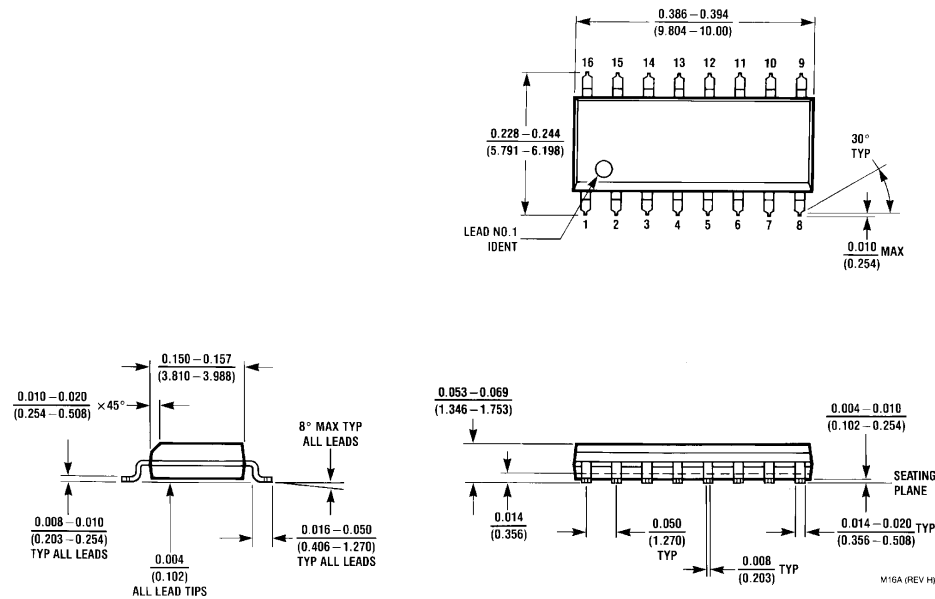

**16-Lead (0.150") Wide
Molded Small Outline Package, JEDEC
Order Number DS8925M
NS Package Number M16A**

LIFE SUPPORT POLICY

NATIONAL'S PRODUCTS ARE NOT AUTHORIZED FOR USE AS CRITICAL COMPONENTS IN LIFE SUPPORT DEVICES OR SYSTEMS WITHOUT THE EXPRESS WRITTEN APPROVAL OF THE PRESIDENT OF NATIONAL SEMICONDUCTOR CORPORATION. As used herein:

1. Life support devices or systems are devices or systems which, (a) are intended for surgical implant into the body, or (b) support or sustain life, and whose failure to perform when properly used in accordance with instructions for use provided in the labeling, can be reasonably expected to result in a significant injury to the user.
2. A critical component in any component of a life support device or system whose failure to perform can be reasonably expected to cause the failure of the life support device or system, or to affect its safety or effectiveness.



National Semiconductor Corporation
Americas
Tel: 1-800-272-9959
Fax: 1-800-737-7018
Email: support@nsc.com

National Semiconductor Europe
Fax: +49 (0) 1 80-530 85 86
Email: europe.support@nsc.com
Deutsch Tel: +49 (0) 1 80-530 85 85
English Tel: +49 (0) 1 80-532 78 32
Français Tel: +49 (0) 1 80-532 93 58
Italiano Tel: +49 (0) 1 80-534 16 80

National Semiconductor Asia Pacific Customer Response Group
Tel: 65-2544466
Fax: 65-2504466
Email: sea.support@nsc.com

National Semiconductor Japan Ltd.
Tel: 81-3-5639-7560
Fax: 81-3-5639-7507

www.national.com