

DS90C031B LVDS Quad CMOS Differential Line Driver

Check for Samples: [DS90C031B](#)

FEATURES

- >155.5 Mbps (77.7 MHz) switching rates
- High impedance LVDS outputs with power-off
- ± 350 mV differential signaling
- Ultra low power dissipation
- 400 ps maximum differential skew (5V, 25°C)
- 3.5 ns maximum propagation delay
- Industrial operating temperature range
- Pin compatible with DS26C31, MB571 (PECL) and 41LG (PECL)
- Conforms to ANSI/TIA/EIA-644 LVDS standard
- Offered in narrow body SOIC package
- Fail-safe logic for floating inputs

DESCRIPTION

The DS90C031B is a quad CMOS differential line driver designed for applications requiring ultra low power dissipation and high data rates. The device supports data rates in excess of 155.5 Mbps (77.7 MHz) and uses Low Voltage Differential Signaling (LVDS) technology.

The DS90C031B accepts TTL/CMOS input levels and translates them to low voltage (350 mV) differential output signals. In addition the driver supports a TRI-STATE function that may be used to disable the output stage, disabling the load current, and thus dropping the device to an ultra low idle power state of 11 mW typical.

In addition, the DS90C031B provides power-off high impedance LVDS outputs. This feature assures minimal loading effect on the LVDS bus lines when V_{CC} is not present.

The DS90C031B and companion line receiver (DS90C032B) provide a new alternative to high power pseudo-ECL devices for high speed point-to-point interface applications.

Connection Diagram

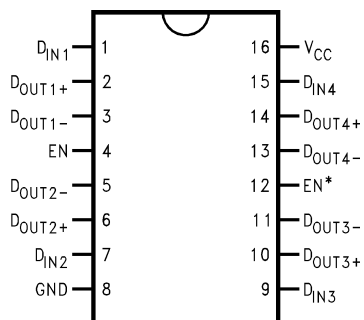
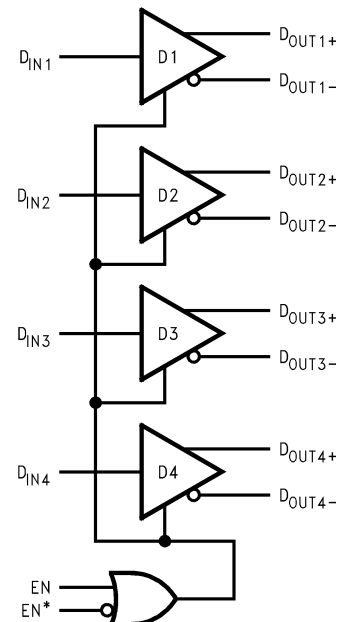

Figure 1. Dual-In-Line
See Package Number D (R-PDSO-G16)

Functional Diagram



Please be aware that an important notice concerning availability, standard warranty, and use in critical applications of Texas Instruments semiconductor products and disclaimers thereto appears at the end of this data sheet.

All trademarks are the property of their respective owners.

Driver Truth Table

| Enables | | Input | Outputs | |
|---|-----|-----------------|-------------------|-------------------|
| EN | EN* | D _{IN} | D _{OUT+} | D _{OUT-} |
| L | H | X | Z | Z |
| All other combinations of ENABLE inputs | | L | L | H |
| | | H | H | L |



These devices have limited built-in ESD protection. The leads should be shorted together or the device placed in conductive foam during storage or handling to prevent electrostatic damage to the MOS gates.

Absolute Maximum Ratings ⁽¹⁾

| | |
|--|------------------------------|
| Supply Voltage (V_{CC}) | -0.3V to +6V |
| Input Voltage (D_{IN}) | -0.3V to ($V_{CC} + 0.3V$) |
| Enable Input Voltage (EN, EN*) | -0.3V to ($V_{CC} + 0.3V$) |
| Output Voltage (D_{OUT+} , D_{OUT-}) | -0.3V to +5.8V |
| Short Circuit Duration (D_{OUT+} , D_{OUT-}) | Continuous |
| Maximum Package Power Dissipation at +25°C | 1068 mW |
| Derate Power Dissipation | 8.5 mW/°C above +25°C |
| Storage Temperature Range | -65°C to +150°C |
| Lead Temperature Range, Soldering (4 seconds) | +260°C |
| Maximum Junction Temperature | +150°C |
| ESD Rating | |
| HBM, 1.5 k Ω , 100 pF | $\geq 2kV$ |
| EIAJ, 0 Ω , 200 pF | $\geq 250V$ |

(1) "Absolute Maximum Ratings" are those values beyond which the safety of the device cannot be guaranteed. They are not meant to imply that the devices should be operated at these limits. The table of "Electrical Characteristics" specifies conditions of device operation.

Recommended Operating Conditions

| | Min | Typ | Max | Units |
|--|------|------|------|-------|
| Supply Voltage (V_{CC}) | +4.5 | +5.0 | +5.5 | V |
| Operating Free Air Temperature (T_A) | -40 | +25 | +85 | °C |

Electrical Characteristics

Over supply voltage and operating temperature ranges, unless otherwise specified. ⁽¹⁾ ⁽²⁾

| Symbol | Parameter | Test Conditions | Pin | Min | Typ | Max | Units | |
|------------------|--|--|--|--|------|----------|-------|----|
| V_{OD1} | Differential Output Voltage | $R_L = 100\Omega$ (Figure 2) | D _{OUT-} , D _{OUT+} | 250 | 345 | 450 | mV | |
| ΔV_{OD1} | Change in Magnitude of V_{OD1} for Complementary Output States | | | | 4 | 35 | mV | |
| V_{OS} | Offset Voltage | | | 1.10 | 1.25 | 1.35 | V | |
| ΔV_{OS} | Change in Magnitude of V_{OS} for Complementary Output States | | | | 5 | 25 | mV | |
| V_{OH} | Output Voltage High | $R_L = 100\Omega$ | | | 1.41 | 1.60 | V | |
| V_{OL} | Output Voltage Low | | | 0.90 | 1.07 | | V | |
| V_{IH} | Input Voltage High | | D _{IN} , EN, EN* | 2.0 | | V_{CC} | V | |
| V_{IL} | Input Voltage Low | | | GND | | 0.8 | V | |
| I_I | Input Current | | | $V_{IN} = V_{CC}, GND, 2.5V$ or $0.4V$ | -10 | ±1 | +10 | µA |
| V_{CL} | Input Clamp Voltage | | | $I_{CL} = -18$ mA | -1.5 | -0.8 | | V |
| I_{OS} | Output Short Circuit Current | $V_{OUT} = 0V^{(3)}$ | D _{OUT-} , D _{OUT+} | | -3.5 | -5.0 | mA | |
| I_{OZ} | Output TRI-STATE Current | EN = 0.8V and EN* = 2.0V, $V_{OUT} = 0V$ or V_{CC} | | -10 | ±1 | +10 | µA | |
| I_{OFF} | Power - Off Leakage | $V_O = 0V$ or $2.4V$, $V_{CC} = 0V$ or Open | | -10 | ±1 | +10 | µA | |
| I_{CC} | No Load Supply Current Drivers Enabled | $D_{IN} = V_{CC}$ or GND | V_{CC} | | 1.7 | 3.0 | mA | |
| | | $D_{IN} = 2.5V$ or $0.4V$ | | | 4.0 | 6.5 | mA | |
| I_{CCL} | Loaded Supply Current Drivers Enabled | $R_L = 100\Omega$ (all channels), $V_{IN} = V_{CC}$ or GND (all inputs) | | | | 15.4 | 21.0 | mA |
| | | | | | | 2.2 | 4.0 | mA |
| I_{CCZ} | No Load Supply Current Drivers Disabled | $D_{IN} = V_{CC}$ or GND, EN = GND, EN* = V_{CC} | | | | | mA | |

- (1) Current into device pins is defined as positive. Current out of device pins is defined as negative. All voltages are referenced to ground except: V_{OD1} and ΔV_{OD1} .
- (2) All typicals are given for: $V_{CC} = +5.0V$, $T_A = +25^\circ C$.
- (3) Output short circuit current (I_{OS}) is specified as magnitude only, minus sign indicates direction only.

Switching Characteristics

 $V_{CC} = +5.0V$, $T_A = +25^{\circ}C$ ⁽¹⁾ ⁽²⁾ ⁽³⁾

| Symbol | Parameter | Conditions | Min | Typ | Max | Units |
|------------|--|--|-----|------|-----|-------|
| t_{PHLD} | Differential Propagation Delay High to Low | $R_L = 100\Omega$, $C_L = 5\text{ pF}$ (Figure 3 and Figure 4) | 1.0 | 2.0 | 3.0 | ns |
| t_{PLHD} | Differential Propagation Delay Low to High | | 1.0 | 2.1 | 3.0 | ns |
| t_{SKD} | Differential Skew $ t_{PHLD} - t_{PLHD} $ | | 0 | 80 | 400 | ps |
| t_{SK1} | Channel-to-Channel Skew ⁽⁴⁾ | | 0 | 300 | 600 | ps |
| t_{TLH} | Rise Time | | | 0.35 | 1.5 | ns |
| t_{THL} | Fall Time | | | 0.35 | 1.5 | ns |
| t_{PHZ} | Disable Time High to Z | $R_L = 100\Omega$, $C_L = 5\text{ pF}$ (Figure 5 and Figure 6) | | 2.5 | 10 | ns |
| t_{PLZ} | Disable Time Low to Z | | | 2.5 | 10 | ns |
| t_{PZH} | Enable Time Z to High | | | 2.5 | 10 | ns |
| t_{PZL} | Enable Time Z to Low | | | 2.5 | 10 | ns |

(1) All typicals are given for: $V_{CC} = +5.0V$, $T_A = +25^{\circ}C$.

(2) Generator waveform for all tests unless otherwise specified: $f = 1\text{ MHz}$, $Z_O = 50\Omega$, $t_r \leq 6\text{ ns}$, and $t_f \leq 6\text{ ns}$.

(3) C_L includes probe and jig capacitance.

(4) Channel-to-Channel Skew is defined as the difference between the propagation delay of the channel and the other channels in the same chip with an event on the inputs.

Switching Characteristics

 $V_{CC} = +5.0V \pm 10\%$, $T_A = -40^{\circ}C$ to $+85^{\circ}C$ ⁽¹⁾ ⁽²⁾ ⁽³⁾

| Symbol | Parameter | Conditions | Min | Typ | Max | Units |
|------------|--|--|------|------|-----|-------|
| t_{PHLD} | Differential Propagation Delay High to Low | $R_L = 100\Omega$, $C_L = 5\text{ pF}$ (Figure 3 and Figure 4) | 0.5 | 2.0 | 3.5 | ns |
| t_{PLHD} | Differential Propagation Delay Low to High | | 0.5 | 2.1 | 3.5 | ns |
| t_{SKD} | Differential Skew $ t_{PHLD} - t_{PLHD} $ | | 0 | 80 | 900 | ps |
| t_{SK1} | Channel-to-Channel Skew ⁽⁴⁾ | | 0 | 0.3 | 1.0 | ns |
| t_{SK2} | Chip to Chip Skew ⁽⁵⁾ | | | | 3.0 | ns |
| t_{TLH} | Rise Time | | | 0.35 | 2.0 | ns |
| t_{THL} | Fall Time | | 0.35 | 2.0 | ns | |
| t_{PHZ} | Disable Time High to Z | $R_L = 100\Omega$, $C_L = 5\text{ pF}$ (Figure 5 and Figure 6) | | 2.5 | 15 | ns |
| t_{PLZ} | Disable Time Low to Z | | | 2.5 | 15 | ns |
| t_{PZH} | Enable Time Z to High | | | 2.5 | 15 | ns |
| t_{PZL} | Enable Time Z to Low | | | 2.5 | 15 | ns |

(1) All typicals are given for: $V_{CC} = +5.0V$, $T_A = +25^{\circ}C$.

(2) Generator waveform for all tests unless otherwise specified: $f = 1\text{ MHz}$, $Z_O = 50\Omega$, $t_r \leq 6\text{ ns}$, and $t_f \leq 6\text{ ns}$.

(3) C_L includes probe and jig capacitance.

(4) Channel-to-Channel Skew is defined as the difference between the propagation delay of the channel and the other channels in the same chip with an event on the inputs.

(5) Chip to Chip Skew is defined as the difference between the minimum and maximum specified differential propagation delays.

PARAMETER MEASUREMENT INFORMATION

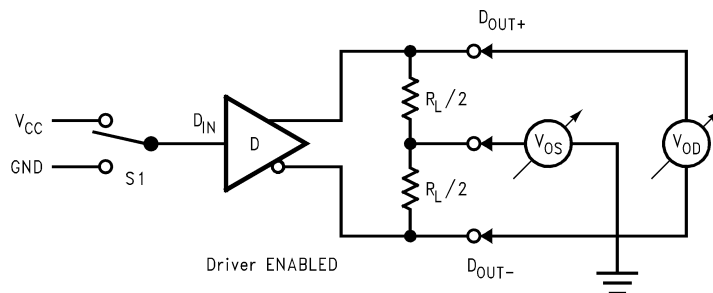

Figure 2. Driver V_{OD} and V_{OS} Test Circuit

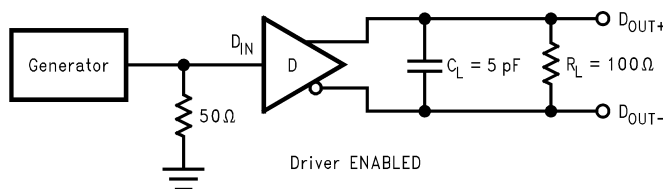

Figure 3. Driver Propagation Delay and Transition Time Test Circuit

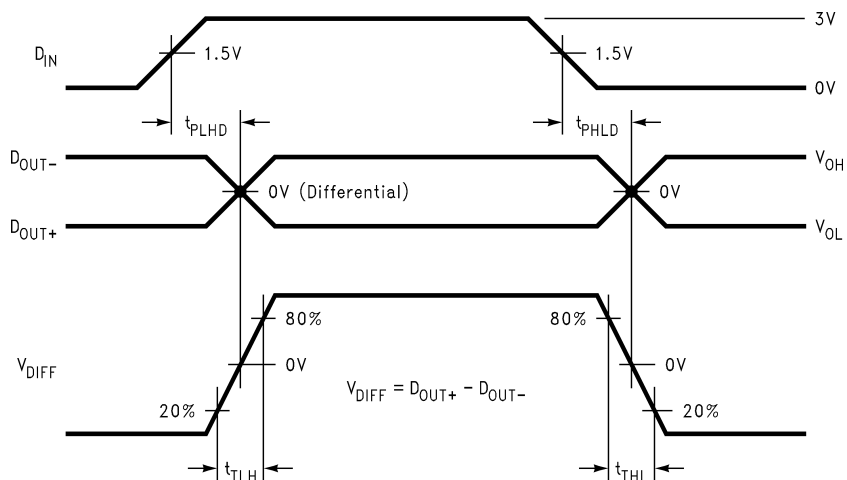

Figure 4. Driver Propagation Delay and Transition Time Waveforms

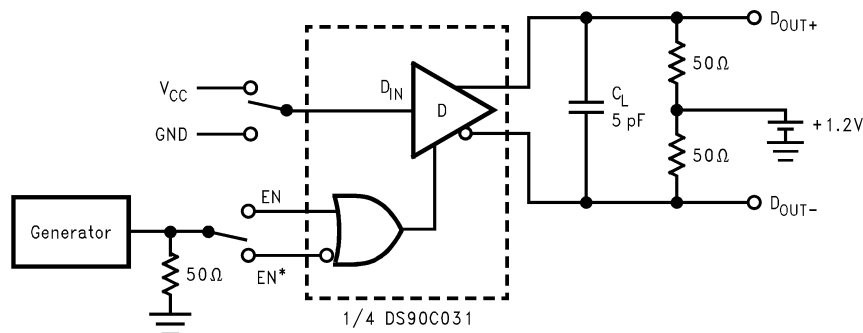

Figure 5. Driver TRI-STATE Delay Test Circuit

PARAMETER MEASUREMENT INFORMATION (continued)

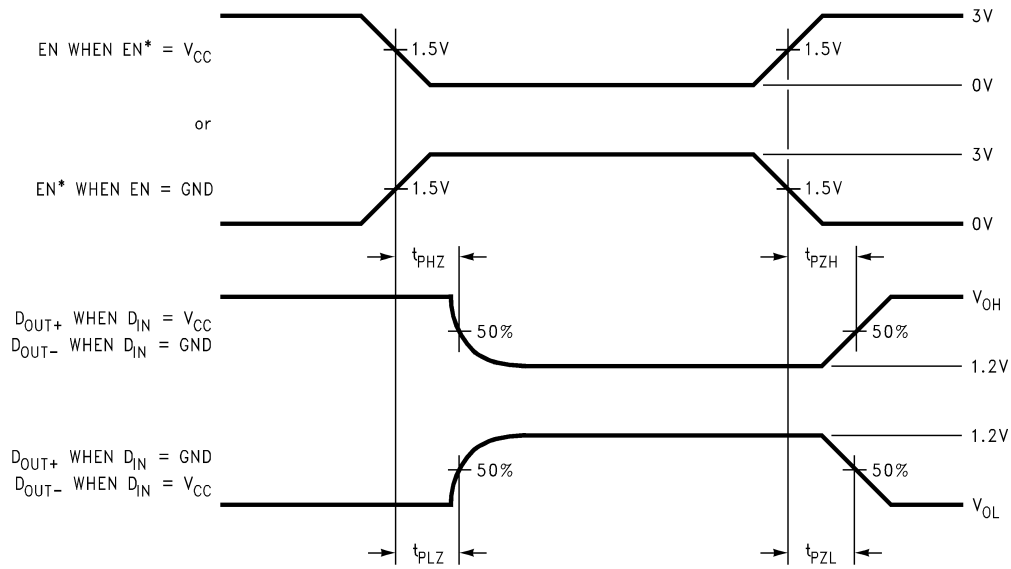

Figure 6. Driver TRI-STATE Delay Waveform

Typical Application

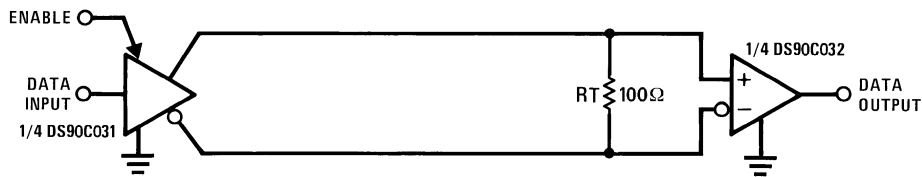

Figure 7. Point-to-Point Application

APPLICATIONS INFORMATION

LVDS drivers and receivers are intended to be primarily used in an uncomplicated point-to-point configuration as is shown in [Figure 7](#). This configuration provides a clean signaling environment for the quick edge rates of the drivers. The receiver is connected to the driver through a balanced media which may be a standard twisted pair cable, a parallel pair cable, or simply PCB traces. Typically, the characteristic impedance of the media is in the range of 100Ω. A termination resistor of 100Ω should be selected to match the media, and is located as close to the receiver input pins as possible. The termination resistor converts the current sourced by the driver into a voltage that is detected by the receiver. Other configurations are possible such as a multi-receiver configuration, but the effects of a mid-stream connector(s), cable stub(s), and other impedance discontinuities as well as ground shifting, noise margin limits, and total termination loading must be taken into account.

The DS90C031B differential line driver is a balanced current source design. A current mode driver, generally speaking has a high output impedance and supplies a constant current for a range of loads (a voltage mode driver on the other hand supplies a constant voltage for a range of loads). Current is switched through the load in one direction to produce a logic state and in the other direction to produce the other logic state. The typical output current is a mere 3.4 mA with a minimum of 2.5 mA, and a maximum of 4.5 mA. The current mode **requires** (as discussed above) that a resistive termination be employed to terminate the signal and to complete the loop as shown in [Figure 7](#). AC or unterminated configurations are not allowed. The 3.4 mA loop current will develop a differential voltage of 340 mV across the 100Ω termination resistor which the receiver detects with a 240 mV minimum differential noise margin neglecting resistive line losses (driven signal minus receiver threshold (340 mV – 100 mV = 240 mV). The signal is centered around +1.2V (Driver Offset, V_{OS}) with respect to ground as shown in [Figure 8](#). Note that the steady-state voltage (V_{SS}) peak-to-peak swing is twice the differential voltage (V_{OD}) and is typically 680 mV.

The current mode driver provides substantial benefits over voltage mode drivers, such as an RS-422 driver. Its quiescent current remains relatively flat versus switching frequency. Whereas the RS-422 voltage mode driver increases exponentially in most case between 20 MHz–50 MHz. This is due to the overlap current that flows between the rails of the device when the internal gates switch. Whereas the current mode driver switches a fixed current between its output without any substantial overlap current. This is similar to some ECL and PECL devices, but without the heavy static I_{CC} requirements of the ECL/PECL designs. LVDS requires > 80% less current than similar PECL devices. AC specifications for the driver are a tenfold improvement over other existing RS-422 drivers.

The fail-safe circuitry guarantees that the outputs are enabled and at a logic "0" (the true output is low and the complement output is high) when the inputs are floating.

The TRI-STATE function allows the driver outputs to be disabled, thus obtaining an even lower power state when the transmission of data is not required.

The footprint of the DS90C031B is the same as the industry standard 26LS31 Quad Differential (RS-422) Driver.

The DS90C031B is electrically similar to the DS90C031, but differs by supporting high impedance LVDS outputs under power-off condition. This allows for multiple or redundant drivers to be used in certain applications. The DS90C031B is offered in a space saving narrow SOIC (150 mil.) package.

For additional LVDS application information, see TI's LVDS Owner's Manual available through TI's website <http://www.ti.com/lstds/ti/analog/interface.page>.

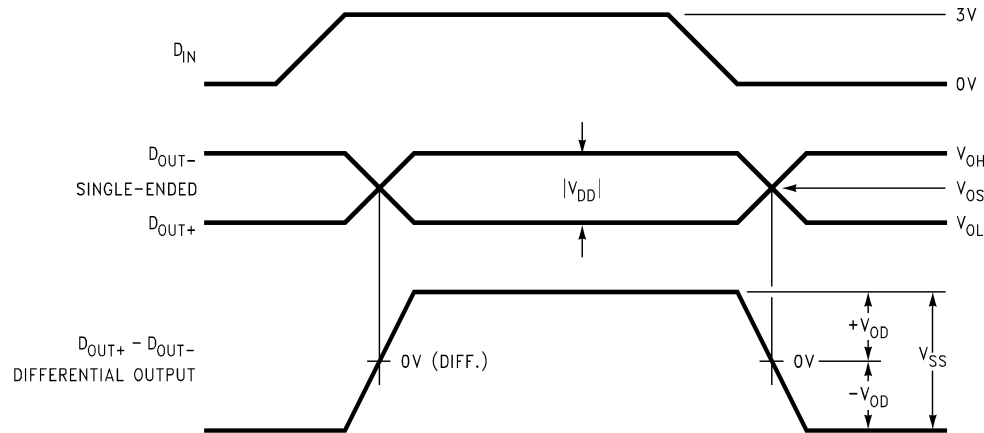

Figure 8. Driver Output Levels

Pin Descriptions

| Pin No. | Name | Description |
|--------------|------------|--|
| 1, 7, 9, 15 | D_{IN} | Driver input pin, TTL/CMOS compatible |
| 2, 6, 10, 14 | D_{OUT+} | Non-inverting driver output pin, LVDS levels |
| 3, 5, 11, 13 | D_{OUT-} | Inverting driver output pin, LVDS levels |
| 4 | EN | Active high enable pin, OR-ed with EN* |
| 12 | EN* | Active low enable pin, OR-ed with EN |
| 16 | V_{CC} | Power supply pin, $+5V \pm 10\%$ |
| 8 | GND | Ground pin |

TYPICAL PERFORMANCE CHARACTERISTICS

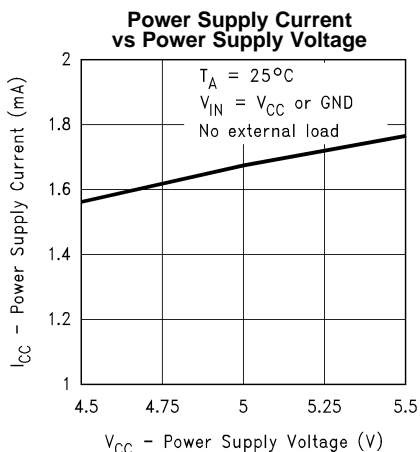

Figure 9.

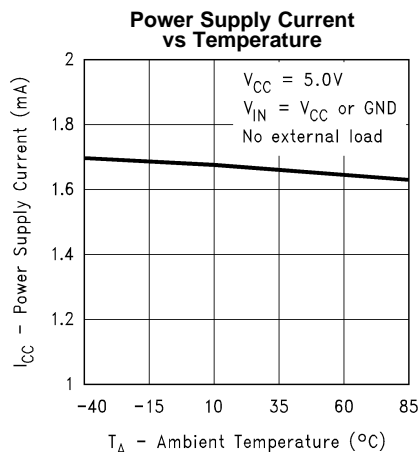

Figure 10.

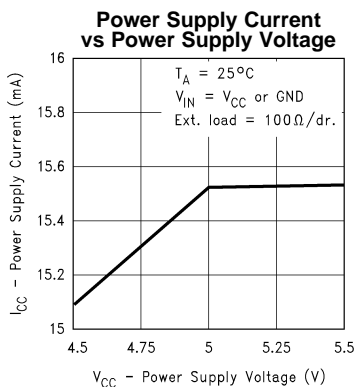

Figure 11.

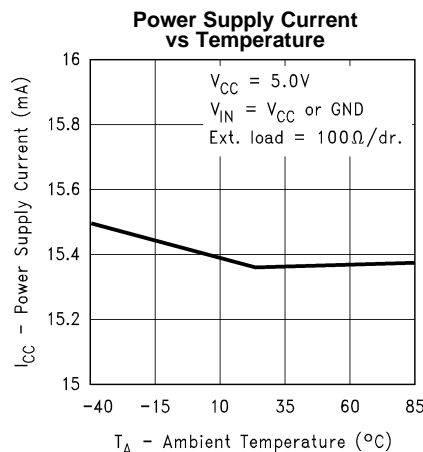

Figure 12.

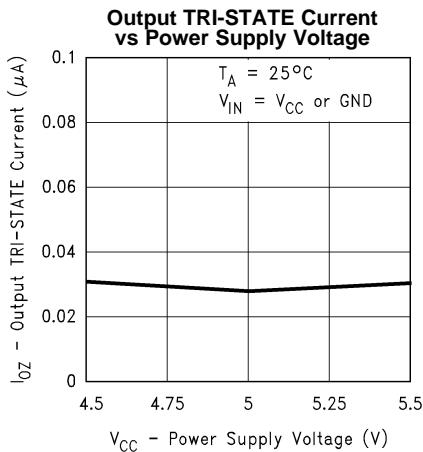

Figure 13.

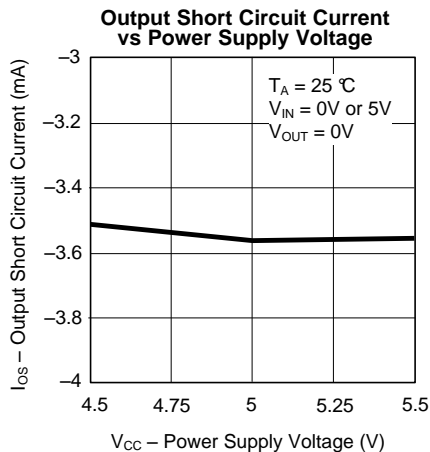

Figure 14.

TYPICAL PERFORMANCE CHARACTERISTICS (continued)

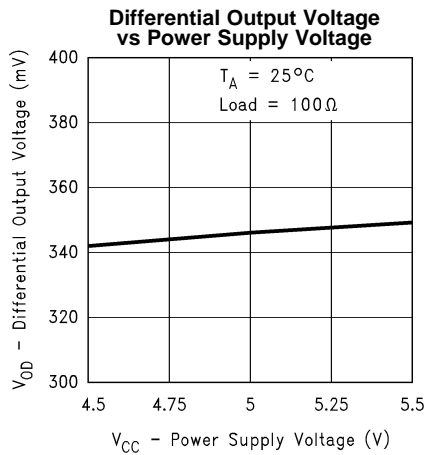

Figure 15.

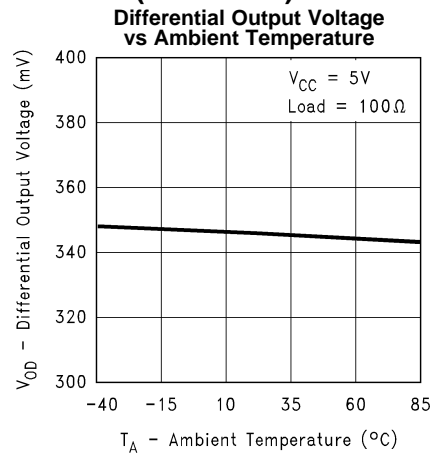

Figure 16.

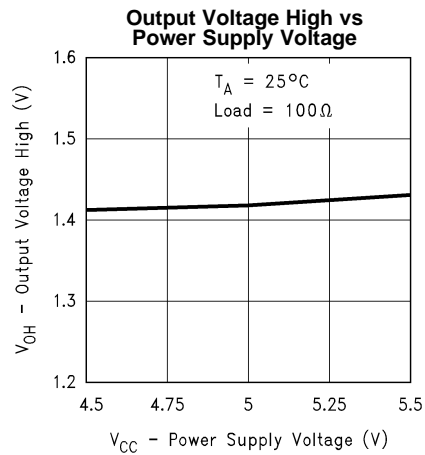

Figure 17.

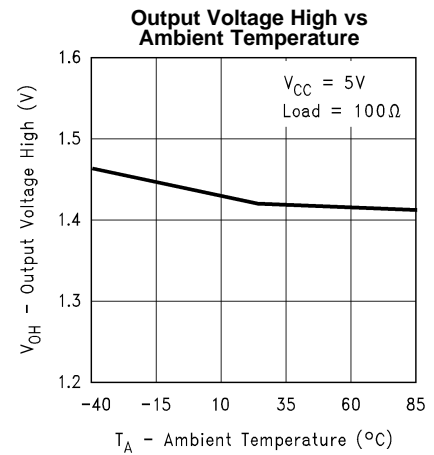

Figure 18.

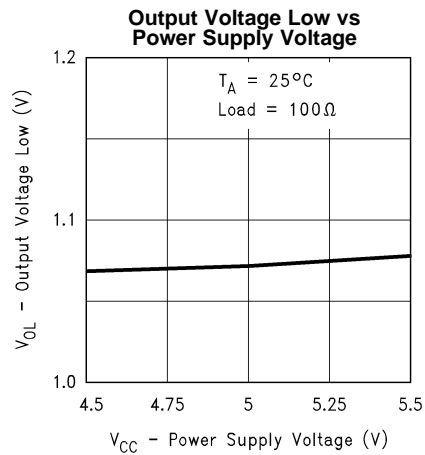

Figure 19.

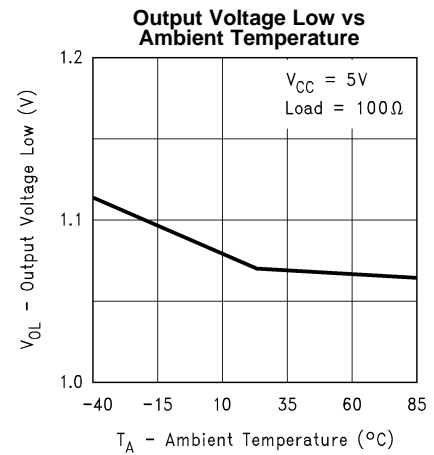

Figure 20.

TYPICAL PERFORMANCE CHARACTERISTICS (continued)

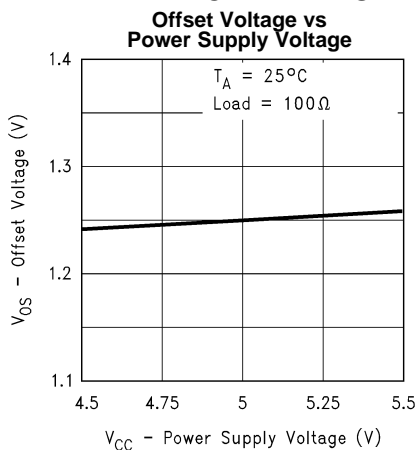

Figure 21.

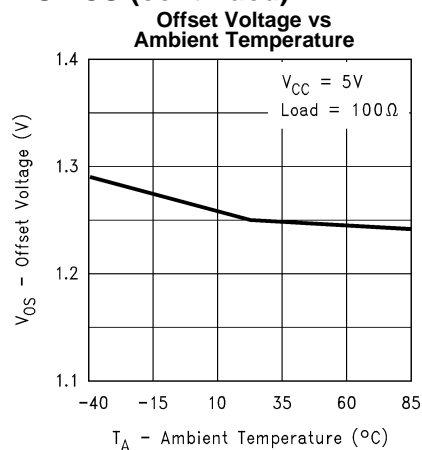

Figure 22.

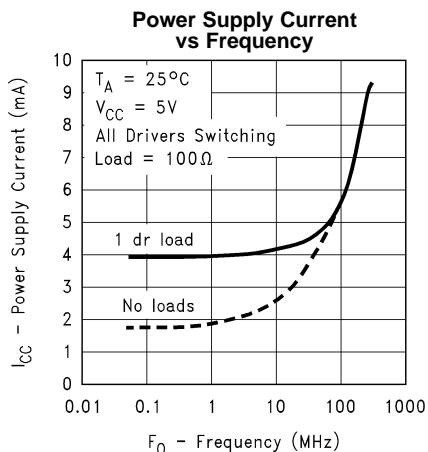

Figure 23.

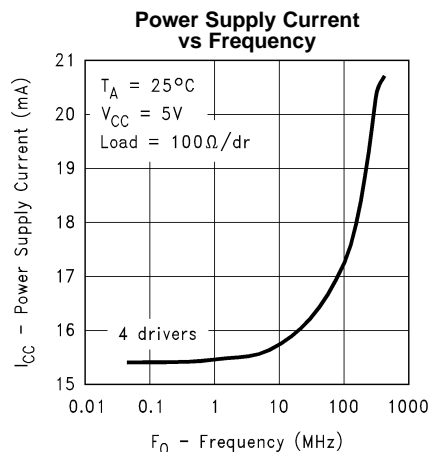

Figure 24.

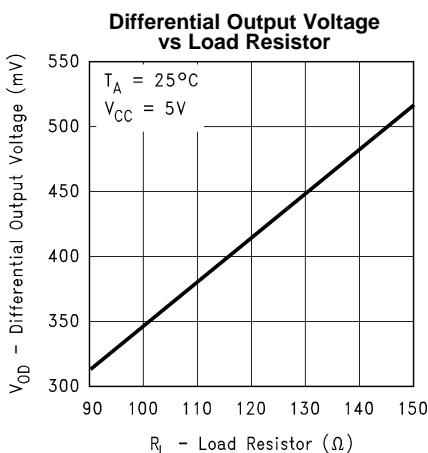

Figure 25.

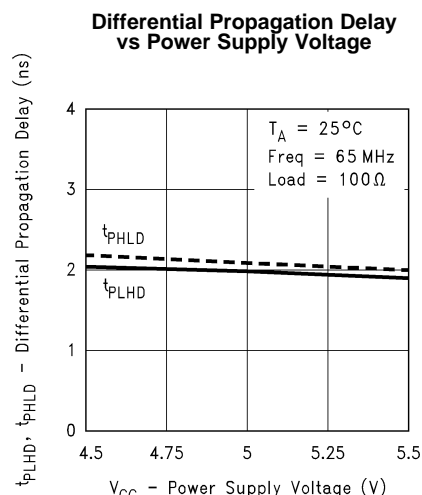

Figure 26.

TYPICAL PERFORMANCE CHARACTERISTICS (continued)

Differential Propagation Delay vs Ambient Temperature

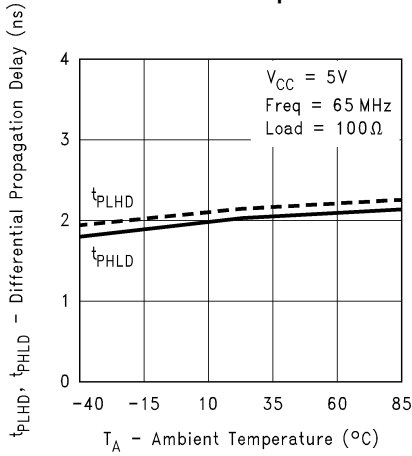

Figure 27.

Differential Skew vs Power Supply Voltage

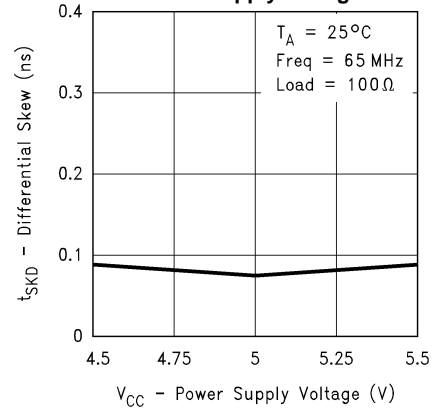

Figure 28.

Differential Skew vs Ambient Temperature

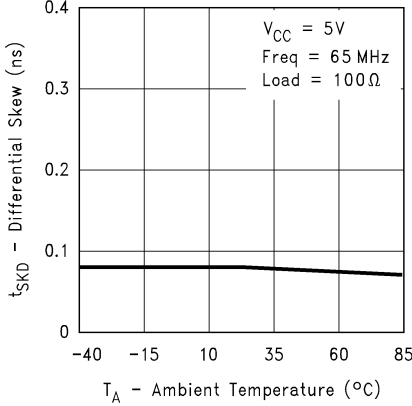

Figure 29.

Differential Transition Time vs Power Supply Voltage

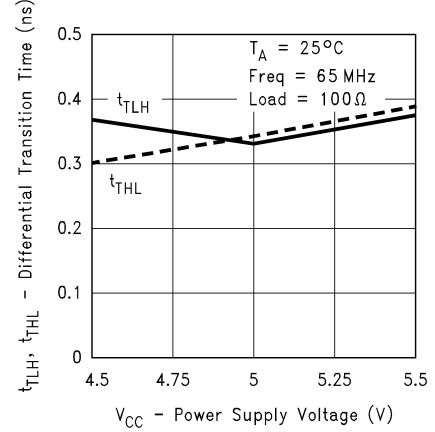

Figure 30.

Differential Transition Time vs Ambient Temperature

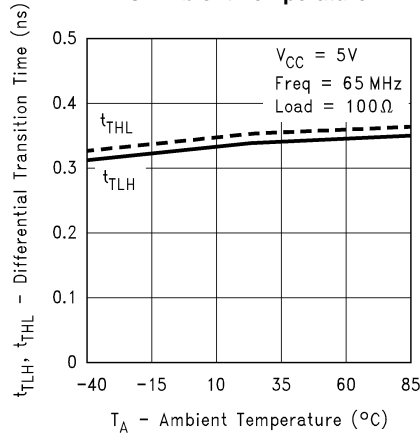

Figure 31.

REVISION HISTORY

| Changes from Revision A (March 2013) to Revision B | Page |
|--|--------------------------|
| <hr/> <ul style="list-style-type: none">• Changed layout of National Data Sheet to TI format | <hr/> 12 |

PACKAGING INFORMATION

| Orderable Device | Status (1) | Package Type | Package Drawing | Pins | Package Qty | Eco Plan (2) | Lead/Ball Finish (6) | MSL Peak Temp (3) | Op Temp (°C) | Device Marking (4/5) | Samples |
|-------------------|---------------|--------------|-----------------|------|-------------|-------------------------|-------------------------|----------------------|--------------|-------------------------|----------------|
| DS90C031BTM | NRND | SOIC | D | 16 | 48 | TBD | Call TI | Call TI | -40 to 85 | DS90C031BTM | |
| DS90C031BTM/NOPB | ACTIVE | SOIC | D | 16 | 48 | Green (RoHS & no Sb/Br) | Call TI SN | Level-1-260C-UNLIM | -40 to 85 | DS90C031BTM | Samples |
| DS90C031BTMX/NOPB | ACTIVE | SOIC | D | 16 | 2500 | Green (RoHS & no Sb/Br) | SN | Level-1-260C-UNLIM | -40 to 85 | DS90C031BTM | Samples |

(1) The marketing status values are defined as follows:

ACTIVE: Product device recommended for new designs.

LIFEBUY: TI has announced that the device will be discontinued, and a lifetime-buy period is in effect.

NRND: Not recommended for new designs. Device is in production to support existing customers, but TI does not recommend using this part in a new design.

PREVIEW: Device has been announced but is not in production. Samples may or may not be available.

OBSOLETE: TI has discontinued the production of the device.

(2) **RoHS:** TI defines "RoHS" to mean semiconductor products that are compliant with the current EU RoHS requirements for all 10 RoHS substances, including the requirement that RoHS substance do not exceed 0.1% by weight in homogeneous materials. Where designed to be soldered at high temperatures, "RoHS" products are suitable for use in specified lead-free processes. TI may reference these types of products as "Pb-Free".

RoHS Exempt: TI defines "RoHS Exempt" to mean products that contain lead but are compliant with EU RoHS pursuant to a specific EU RoHS exemption.

Green: TI defines "Green" to mean the content of Chlorine (Cl) and Bromine (Br) based flame retardants meet JS709B low halogen requirements of <=1000ppm threshold. Antimony trioxide based flame retardants must also meet the <=1000ppm threshold requirement.

(3) MSL, Peak Temp. - The Moisture Sensitivity Level rating according to the JEDEC industry standard classifications, and peak solder temperature.

(4) There may be additional marking, which relates to the logo, the lot trace code information, or the environmental category on the device.

(5) Multiple Device Markings will be inside parentheses. Only one Device Marking contained in parentheses and separated by a "~" will appear on a device. If a line is indented then it is a continuation of the previous line and the two combined represent the entire Device Marking for that device.

(6) Lead/Ball Finish - Orderable Devices may have multiple material finish options. Finish options are separated by a vertical ruled line. Lead/Ball Finish values may wrap to two lines if the finish value exceeds the maximum column width.

Important Information and Disclaimer:The information provided on this page represents TI's knowledge and belief as of the date that it is provided. TI bases its knowledge and belief on information provided by third parties, and makes no representation or warranty as to the accuracy of such information. Efforts are underway to better integrate information from third parties. TI has taken and continues to take reasonable steps to provide representative and accurate information but may not have conducted destructive testing or chemical analysis on incoming materials and chemicals. TI and TI suppliers consider certain information to be proprietary, and thus CAS numbers and other limited information may not be available for release.

In no event shall TI's liability arising out of such information exceed the total purchase price of the TI part(s) at issue in this document sold by TI to Customer on an annual basis.

TAPE AND REEL INFORMATION



QUADRANT ASSIGNMENTS FOR PIN 1 ORIENTATION IN TAPE



*All dimensions are nominal

| Device | Package Type | Package Drawing | Pins | SPQ | Reel Diameter (mm) | Reel Width W1 (mm) | A0 (mm) | B0 (mm) | K0 (mm) | P1 (mm) | W (mm) | Pin1 Quadrant |
|-------------------|--------------|-----------------|------|------|--------------------|--------------------|---------|---------|---------|---------|--------|---------------|
| DS90C031BTMX/NOPB | SOIC | D | 16 | 2500 | 330.0 | 16.4 | 6.5 | 10.3 | 2.3 | 8.0 | 16.0 | Q1 |

TAPE AND REEL BOX DIMENSIONS



*All dimensions are nominal

| Device | Package Type | Package Drawing | Pins | SPQ | Length (mm) | Width (mm) | Height (mm) |
|-------------------|--------------|-----------------|------|------|-------------|------------|-------------|
| DS90C031BTMX/NOPB | SOIC | D | 16 | 2500 | 367.0 | 367.0 | 35.0 |

D (R-PDSO-G16)

PLASTIC SMALL OUTLINE

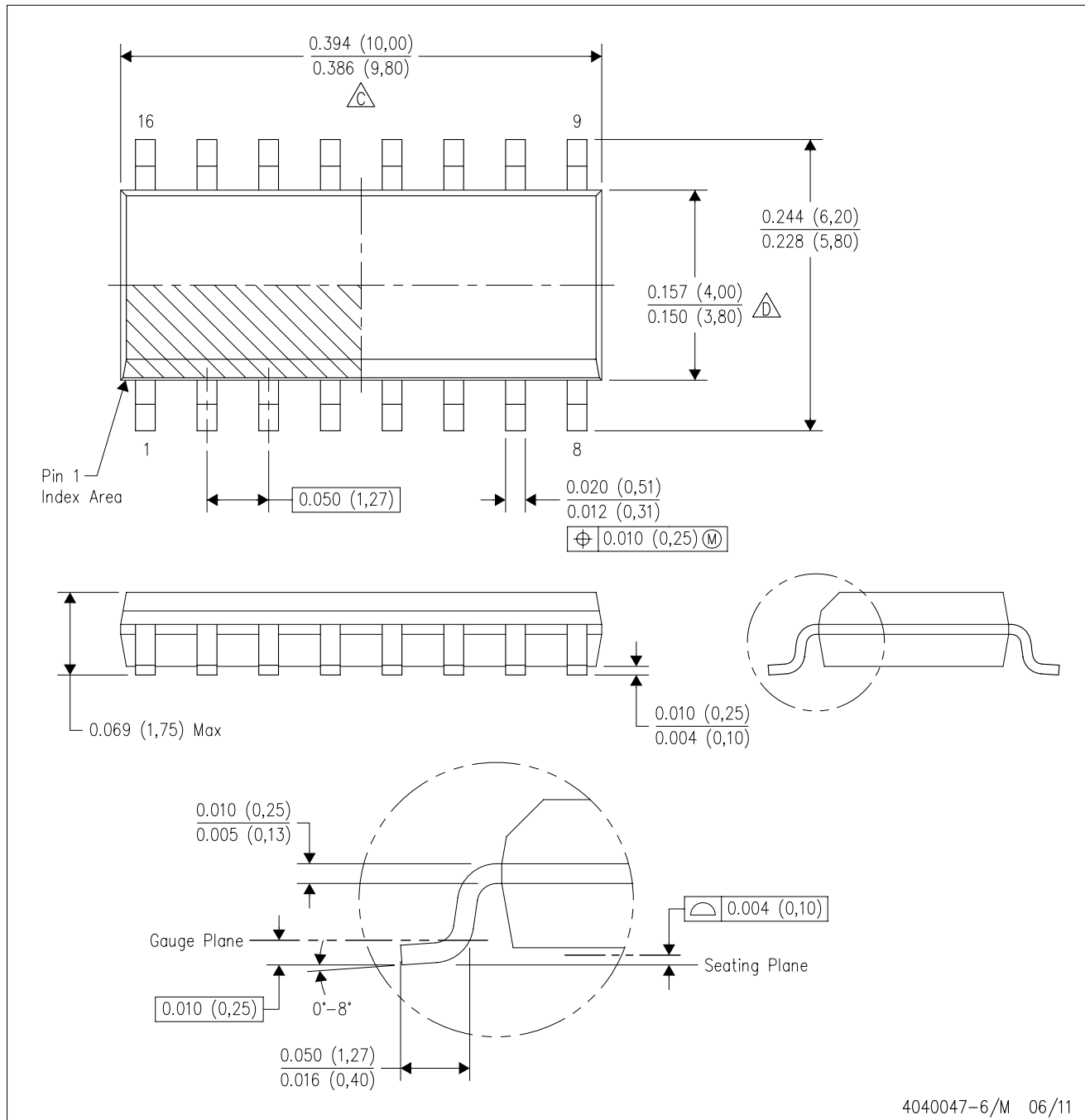

- NOTES:
- A. All linear dimensions are in inches (millimeters).
 - B. This drawing is subject to change without notice.
 - C. Body length does not include mold flash, protrusions, or gate burrs. Mold flash, protrusions, or gate burrs shall not exceed 0.006 (0,15) each side.
 - D. Body width does not include interlead flash. Interlead flash shall not exceed 0.017 (0,43) each side.
 - E. Reference JEDEC MS-012 variation AC.

IMPORTANT NOTICE AND DISCLAIMER

TI PROVIDES TECHNICAL AND RELIABILITY DATA (INCLUDING DATASHEETS), DESIGN RESOURCES (INCLUDING REFERENCE DESIGNS), APPLICATION OR OTHER DESIGN ADVICE, WEB TOOLS, SAFETY INFORMATION, AND OTHER RESOURCES "AS IS" AND WITH ALL FAULTS, AND DISCLAIMS ALL WARRANTIES, EXPRESS AND IMPLIED, INCLUDING WITHOUT LIMITATION ANY IMPLIED WARRANTIES OF MERCHANTABILITY, FITNESS FOR A PARTICULAR PURPOSE OR NON-INFRINGEMENT OF THIRD PARTY INTELLECTUAL PROPERTY RIGHTS.

These resources are intended for skilled developers designing with TI products. You are solely responsible for (1) selecting the appropriate TI products for your application, (2) designing, validating and testing your application, and (3) ensuring your application meets applicable standards, and any other safety, security, or other requirements. These resources are subject to change without notice. TI grants you permission to use these resources only for development of an application that uses the TI products described in the resource. Other reproduction and display of these resources is prohibited. No license is granted to any other TI intellectual property right or to any third party intellectual property right. TI disclaims responsibility for, and you will fully indemnify TI and its representatives against, any claims, damages, costs, losses, and liabilities arising out of your use of these resources.

TI's products are provided subject to TI's Terms of Sale (www.ti.com/legal/termsofsale.html) or other applicable terms available either on ti.com or provided in conjunction with such TI products. TI's provision of these resources does not expand or otherwise alter TI's applicable warranties or warranty disclaimers for TI products.

Mailing Address: Texas Instruments, Post Office Box 655303, Dallas, Texas 75265
Copyright © 2020, Texas Instruments Incorporated