

DS90CR563/DS90CR564 LVDS 18-Bit Color Flat Panel Display (FPD) Link— 65 MHz

General Description

The DS90CR563 transmitter converts 21 bits of CMOS/TTL data into three LVDS (Low Voltage Differential Signaling) data streams. A phase-locked transmit clock is transmitted in parallel with the data streams over a fourth LVDS link. Every cycle of the transmit clock 21 bits of input data are sampled and transmitted. The DS90CR564 receiver converts the LVDS data streams back into 21 bits of CMOS/TTL data. At a transmit clock frequency of 65 MHz, 18 bits of RGB data and 3 bits of LCD timing and control data (FPLINE, FPFREAME, DRDY) are transmitted at a rate of 455 Mbps per LVDS data channel. Using a 65 MHz clock, the data throughput is 171 Mbytes per second. These devices are offered with rising edge data strobes for convenient interface with a variety of graphics and LCD panel controllers.

This chipset is an ideal means to solve EMI and cable size problems associated with wide, high speed TTL interfaces.

Features

- 20 to 65 MHz shift clk support
- Up to 171 Mbytes/s bandwidth
- Cable size is reduced to save cost
- 290 mV swing LVDS devices for low EMI
- Low power CMOS design (< 550 mW typ)
- Power-down mode saves power (< 0.25 mW)
- PLL requires no external components
- Low profile 48-lead TSSOP package
- Rising edge data strobe
- Compatible with TIA/EIA-644 LVDS standard
- Single pixel per clock XGA (1024 x 768)
- Supports VGA, SVGA, XGA and higher
- 1.3 Gbps throughput

Block Diagrams

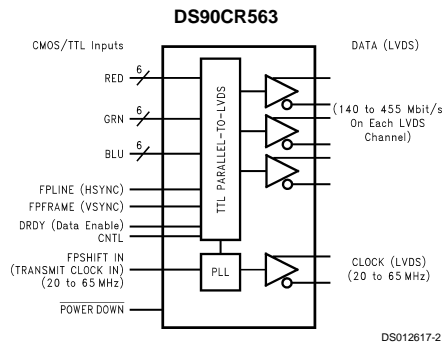

Order Number DS90CR563MTD
See NS Package Number MTD48

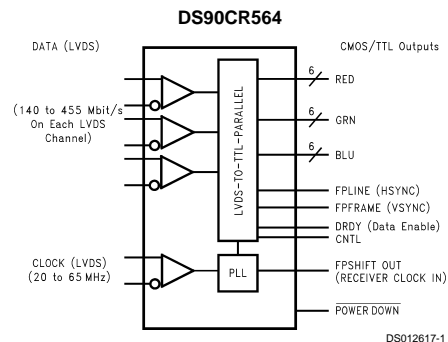

Order Number DS90CR564MTD
See NS Package Number MTD48

Block Diagrams (Continued)

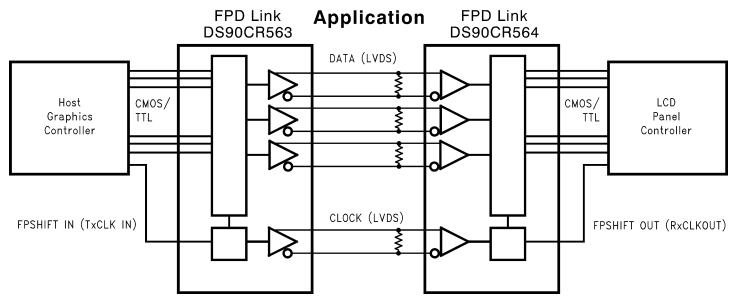

DS012617-3

Absolute Maximum Ratings (Note 1)

If Military/Aerospace specified devices are required, please contact the National Semiconductor Sales Office/Distributors for availability and specifications.

Supply Voltage (V_{CC})	-0.3V to +6V
CMOS/TTL Input Voltage	-0.3V to ($V_{CC} + 0.3V$)
CMOS/TTL Output Voltage	-0.3V to ($V_{CC} + 0.3V$)
LVDS Receiver Input Voltage	-0.3V to ($V_{CC} + 0.3V$)
LVDS Driver Output Voltage	-0.3V to ($V_{CC} + 0.3V$)
LVDS Output Short Circuit Duration	Continuous
Junction Temperature	+150°C
Storage Temperature	-65°C to +150°C
Lead Temperature (Soldering, 4 sec)	+260°C
Maximum Package Power Dissipation @ +25°C	
MTD48 (TSSOP) Package:	

DS90CR563	1.98W
DS90CR564	1.89W
Package Derating:	
DS90CR563	16 mW/°C above +25°C
DS90CR564	15 mW/°C above +25°C
This device does not meet 2000V ESD rating (Note 4).	

Recommended Operating Conditions

	Min	Nom	Max	Units
Supply Voltage (V_{CC})	4.75	5.0	5.25	V
Operating Free Air Temperature (T_A)	-10	+25	+70	°C
Receiver Input Range	0		2.4	V
Supply Noise Voltage (V_{CC})			100	mV _{P-P}

Electrical Characteristics

Over recommended operating supply and temperature ranges unless otherwise specified

Symbol	Parameter	Conditions	Min	Typ	Max	Units	
CMOS/TTL DC SPECIFICATIONS							
V_{IH}	High Level Input Voltage		2.0		V_{CC}	V	
V_{IL}	Low Level Input Voltage		GND		0.8	V	
V_{OH}	High Level Output Voltage	$I_{OH} = -0.4$ mA	3.8	4.9		V	
V_{OL}	Low Level Output Voltage	$I_{OL} = 2$ mA		0.1	0.3	V	
V_{CL}	Input Clamp Voltage	$I_{CL} = -18$ mA		-0.79	-1.5	V	
I_{IN}	Input Current	$V_{IN} = V_{CC}$, GND, 2.5V or 0.4V		±5.1	±10	µA	
I_{OS}	Output Short Circuit Current	$V_{OUT} = 0V$			-120	mA	
LVDS DRIVER DC SPECIFICATIONS							
V_{OD}	Differential Output Voltage	$R_L = 100\Omega$	250	290	450	mV	
ΔV_{OD}	Change in V_{OD} between Complementary Output States				35	mV	
V_{CM}	Common Mode Voltage		1.1	1.25	1.375	V	
ΔV_{CM}	Change in V_{CM} between Complementary Output States				35	mV	
V_{OH}	High Level Output Voltage			1.3	1.6	V	
V_{OL}	Low Level Output Voltage		0.9	1.01		V	
I_{OS}	Output Short Circuit Current	$V_{OUT} = 0V$, $R_L = 100\Omega$		-2.9	-5	mA	
I_{OZ}	Output TRI-STATE® Current	Power Down = 0V, $V_{OUT} = 0V$ or V_{CC}		±1	±10	µA	
LVDS RECEIVER DC SPECIFICATIONS							
V_{TH}	Differential Input High Threshold	$V_{CM} = +1.2V$			+100	mV	
V_{TL}	Differential Input Low Threshold		-100			mV	
I_{IN}	Input Current	$V_{IN} = +2.4V$			±10	µA	
		$V_{IN} = 0V$			±10	µA	
TRANSMITTER SUPPLY CURRENT							
I_{CCTW}	Transmitter Supply Current, Worst Case	$R_L = 100\Omega$, $C_L = 5$ pF, Worst Case Pattern (Figures 1, 3)	$f = 32.5$ MHz		49	63	mA
			$f = 37.5$ MHz		51	64	mA
			$f = 65$ MHz		70	84	mA
I_{CCTG}	Transmitter Supply Current, 16 Grayscale	$R_L = 100\Omega$, $C_L = 5$ pF, 16 Grayscale Pattern (Figures 2, 3)	$f = 32.5$ MHz		40	55	mA
			$f = 37.5$ MHz		41	55	mA
			$f = 65$ MHz		55	67	mA

Electrical Characteristics (Continued)

Over recommended operating supply and temperature ranges unless otherwise specified

Symbol	Parameter	Conditions	Min	Typ	Max	Units	
TRANSMITTER SUPPLY CURRENT							
I_{CCTZ}	Transmitter Supply Current, Power Down	Power Down = Low		1	25	μA	
RECEIVER SUPPLY CURRENT							
I_{CCRW}	Receiver Supply Current, Worst Case	$C_L = 8 \text{ pF}$, Worst Case Pattern (Figures 1, 4)	$f = 32.5 \text{ MHz}$		64	77	mA
			$f = 37.5 \text{ MHz}$		70	85	mA
			$f = 65 \text{ MHz}$		110	140	mA
I_{CCRG}	Receiver Supply Current, 16 Grayscale	$C_L = 8 \text{ pF}$, 16 Grayscale Pattern (Figures 2, 4)	$f = 32.5 \text{ MHz}$		35	55	mA
			$f = 37.5 \text{ MHz}$		37	55	mA
			$f = 65 \text{ MHz}$		55	67	mA
I_{CCRZ}	Receiver Supply Current, Power Down	Power Down = Low		1	10	μA	

Note 1: "Absolute Maximum Ratings" are those values beyond which the safety of the device cannot be guaranteed. They are not meant to imply that the device should be operated at these limits. The tables of "Electrical Characteristics" specify conditions for device operation.

Note 2: Typical values are given for $V_{\text{CC}} = 5.0\text{V}$ and $T_A = +25^\circ\text{C}$.

Note 3: Current into device pins is defined as positive. Current out of device pins is defined as negative. Voltages are referenced to ground unless otherwise specified (except V_{OD} and ΔV_{OD}).

Note 4: ESD Rating: HBM (1.5 k Ω , 100 pF)

PLL $V_{\text{CC}} \geq 1000\text{V}$

All other pins $\geq 2000\text{V}$

EIAJ (0 Ω , 200 pF) $\geq 150\text{V}$

Transmitter Switching Characteristics

Over recommended operating supply and temperature ranges unless otherwise specified

Symbol	Parameter	Min	Typ	Max	Units
LLHT	LVDS Low-to-High Transition Time (Figure 3)		0.75	1.5	ns
LHLT	LVDS High-to-Low Transition Time (Figure 3)		0.75	1.5	ns
TCIT	TxCLK IN Transition Time (Figure 5)			8	ns
TCCS	TxOUT Channel-to-Channel Skew (Note 5) (Figure 6)			350	ps
TCCD	TxCLK IN to TxCLK OUT Delay @ 25°C, $V_{\text{CC}} = 5.0\text{V}$ (Figure 9)	3.5		8.5	ns
TCIP	TxCLK IN Period (Figure 7)	15	T	50	ns
TCIH	TxCLK IN High Time (Figure 7)	0.35T	0.5T	0.65T	ns
TCIL	TxCLK IN Low Time (Figure 7)	0.35T	0.5T	0.65T	ns
TSTC	TxIN Setup to TxCLK IN (Figure 7)	5	3.5		ns
THTC	TxIN Hold to TxCLK IN (Figure 7)				
TPDD	Transmitter Powerdown Delay (Figure 18)			100	ns
TPLLS	Transmitter Phase Lock Loop Set (Figure 11)			10	ms
TPPos0	Transmitter Output Pulse Position 0 (Figure 13)	-0.30	0	0.30	ns
TPPos1	Transmitter Output Pulse Position 1	1.70	$1/7 T_{\text{clk}}$	2.50	ns
TPPos2	Transmitter Output Pulse Position 2	3.60	$2/7 T_{\text{clk}}$	4.50	ns
TPPos3	Transmitter Output Pulse Position 3	5.90	$3/7 T_{\text{clk}}$	6.75	ns
TPPos4	Transmitter Output Pulse Position 4	8.30	$4/7 T_{\text{clk}}$	9.00	ns
TPPos5	Transmitter Output Pulse Position 5	10.40	$5/7 T_{\text{clk}}$	11.10	ns
TPPos6	Transmitter Output Pulse Position 6	12.70	$6/7 T_{\text{clk}}$	13.40	ns

Note 5: This limit based on bench characterization.

Receiver Switching Characteristics

Over recommended operating supply and temperature ranges unless otherwise specified.

Symbol	Parameter	Min	Typ	Max	Units
CLHT	CMOS/TTL Low-to-High Transition Time (Figure 4)		2.5	4.0	ns
CHLT	CMOS/TTL High-to-Low Transition Time (Figure 4)		2.0	3.5	ns
RCOP	RxCLK OUT Period	15	T	50	ns
RCOH	RxCLK OUT High Time	f = 65 MHz	3.8	5	ns
RCOL	RxCLK OUT Low Time	f = 65 MHz	7.8	9	ns
RSRC	RxOUT Setup to RxCLK OUT	f = 65 MHz	2.5	4.2	ns
RHRC	RxOUT Hold to RxCLK OUT	f = 65 MHz	4.0	5.2	ns
RCCD	RxCLK IN to RxCLK OUT Delay @ 25°C, V _{CC} = 5.0V (Figure 10)	6.4		10.7	ns
RPLLS	Receiver Phase Lock Loop Set (Figure 12)			10	ms
RSKM	RxIN Skew Margin (Note 6) (Figure 14)	V _{CC} = 5V, T _A = 25°C	600		ps
RPDD	Receiver Powerdown (Figure 17)			1	µs

Note 6: Receiver Skew Margin is defined as the valid data sampling region at the receiver inputs. This margin takes into account transmitter output skew (TCCS) and the setup and hold time (internal data sampling window), allowing for LVDS cable skew dependent on type/length and source clock (TxCLK IN) jitter.
 $RSKM \geq \text{cable skew (type, length)} + \text{source clock jitter (cycle to cycle)}$

AC Timing Diagrams

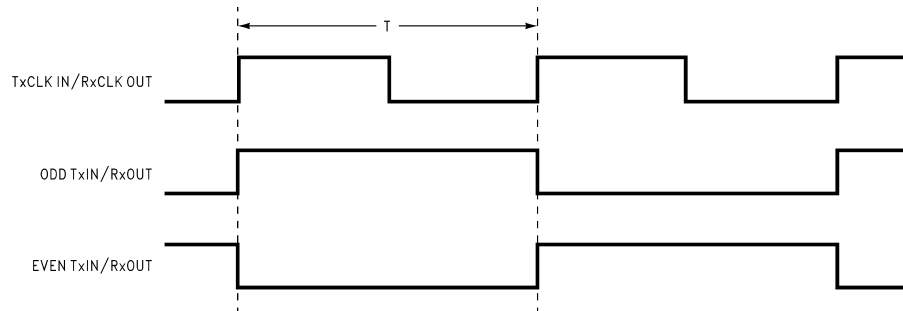

DS012617-4

FIGURE 1. "Worst Case" Test Pattern

AC Timing Diagrams (Continued)

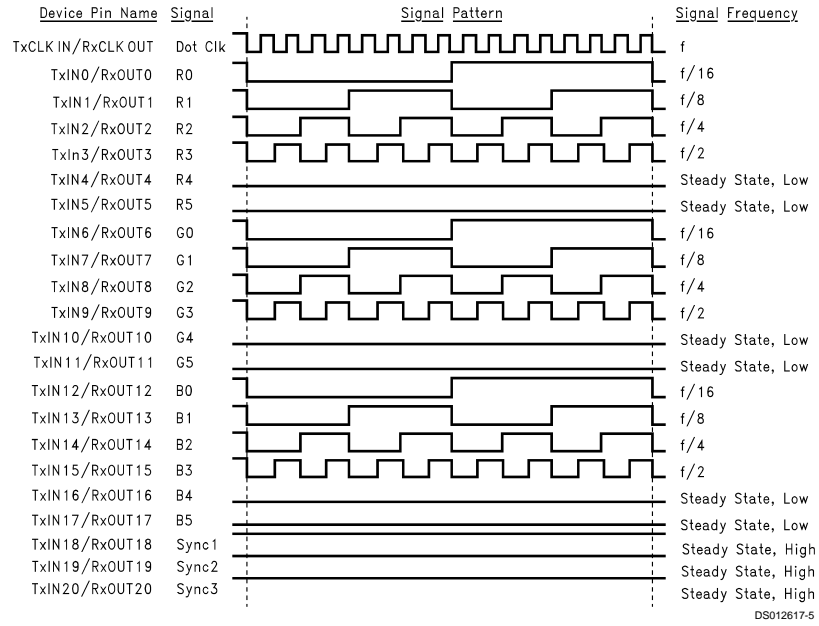

FIGURE 2. "16 Grayscale" Test Pattern

Note 7: The worst case test pattern produces a maximum toggling of digital circuits, LVDS I/O and CMOS/TTL I/O.

Note 8: The 16 grayscale test pattern tests device power consumption for a "typical" LCD display pattern. The test pattern approximates signal switching needed to produce groups of 16 vertical stripes across the display.

Note 9: Figure 1 and Figure 2 show a falling edge data strobe (TxCLK IN/RxCLK OUT).

Note 10: Recommended pin to signal mapping. Customer may choose to define differently.

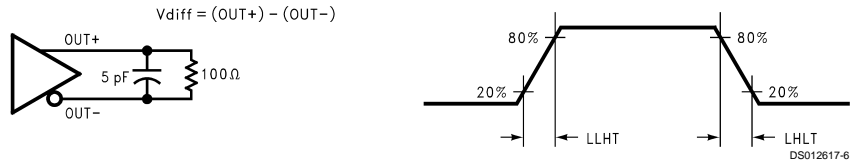

FIGURE 3. DS90CR563 (Transmitter) LVDS Output Load and Transition Times

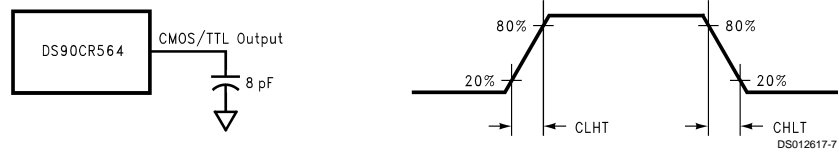

FIGURE 4. DS90CR564 (Receiver) CMOS/TTL Output Load and Transition Times

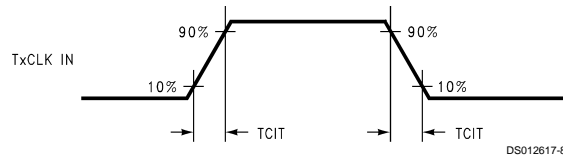
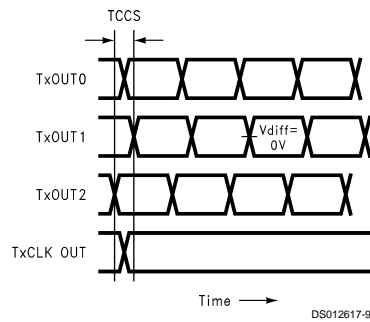

FIGURE 5. DS90CR563 (Transmitter) Input Clock Transition Time

AC Timing Diagrams (Continued)



Note: Measurements at $V_{diff} = 0V$

Note: TCSS measured between earliest and latest LVDS edges.

Note: TxCLK Differential High→Low Edge

FIGURE 6. DS90CR563 (Transmitter) Channel-to-Channel Skew and Pulse Width

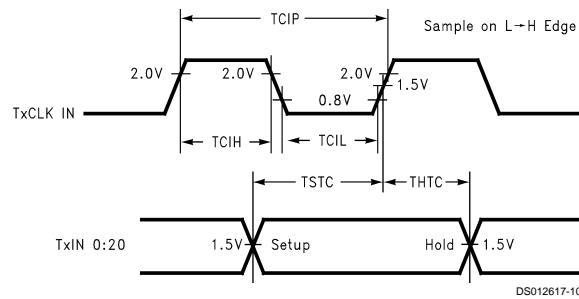

FIGURE 7. DS90CR563 Setup/Hold and High/Low Times

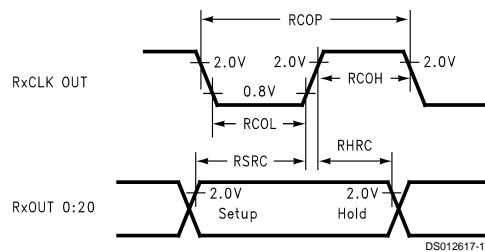

FIGURE 8. DS90CR564 Setup/Hold and High/Low Times

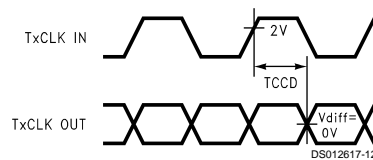

FIGURE 9. DS90CR563 (Transmitter) Clock In to Clock Out Delay

AC Timing Diagrams (Continued)

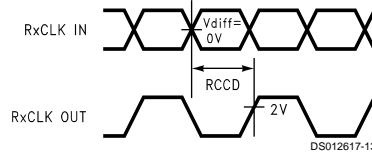

FIGURE 10. DS90CR564 (Receiver) Clock In to Clock Out Delay

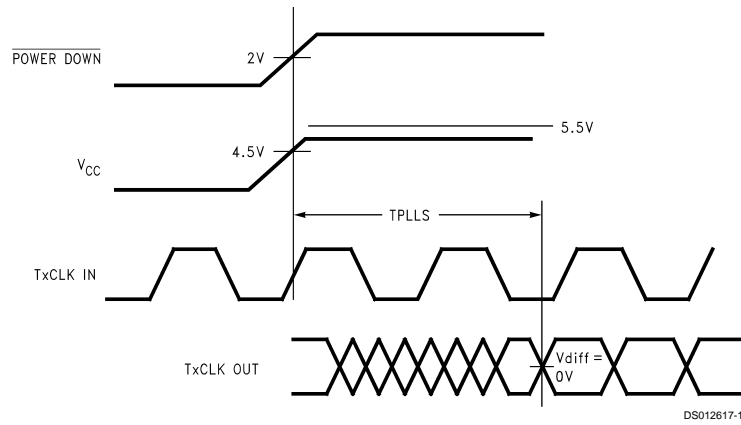

FIGURE 11. DS90CR563 (Transmitter) Phase Lock Loop Set Time

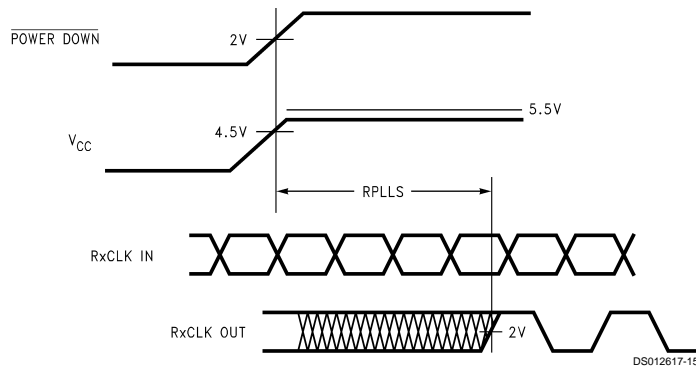
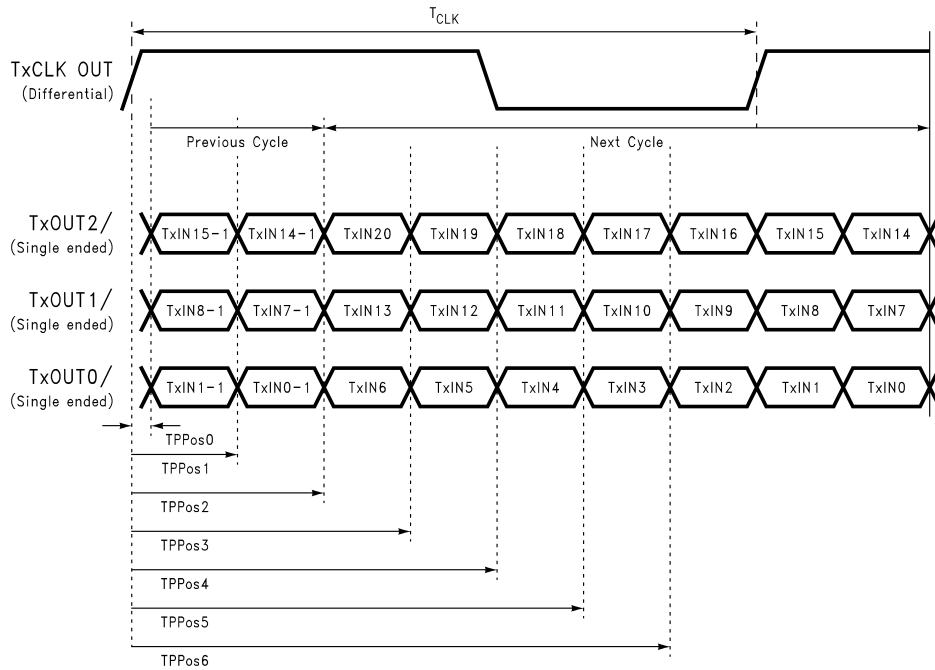

FIGURE 12. DS90CR564 (Receiver) Phase Lock Loop Set Time

AC Timing Diagrams (Continued)



DS012617-16

FIGURE 13. Transmitter LVDS Output Pulse Position Measurement

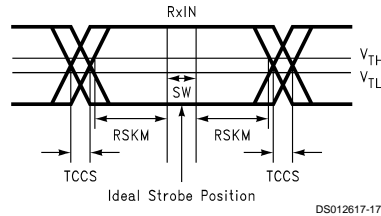

DS012617-17

SW — Setup and Hold Time (Internal Data Sampling Window)
 TCCS — Transmitter Output Skew
 $RSKM \geq \text{Cable Skew (type, length)} + \text{Source Clock Jitter (cycle to cycle)}$
 Cable Skew — typically 10 ps–40 ps per foot

FIGURE 14. Receiver LVDS Input Skew Margin

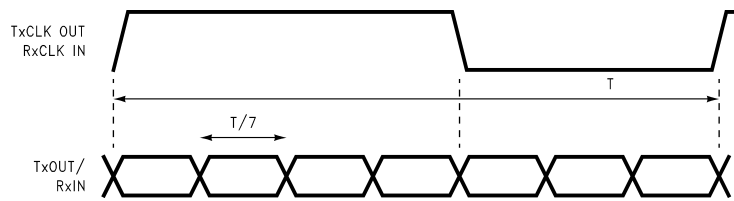

DS012617-18

FIGURE 15. Seven Bits of LVDS in One Clock Cycle

AC Timing Diagrams (Continued)

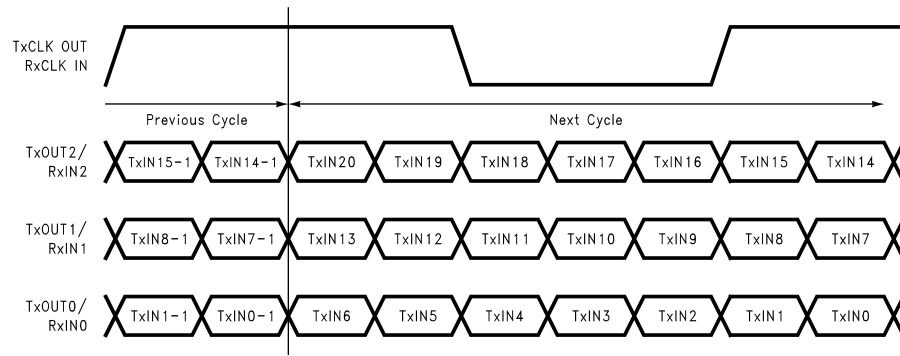

DS012617-19

FIGURE 16. 21 Parallel TTL Data Inputs Mapped to LVDS Outputs (DS90CR563)

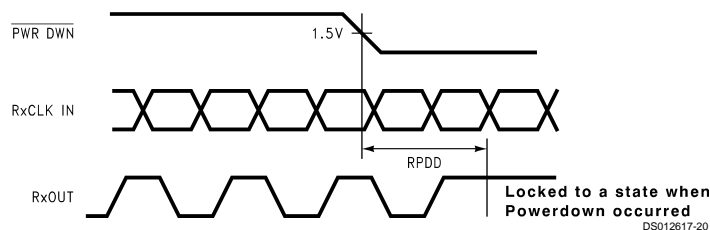

DS012617-20

FIGURE 17. Receiver Powerdown Delay

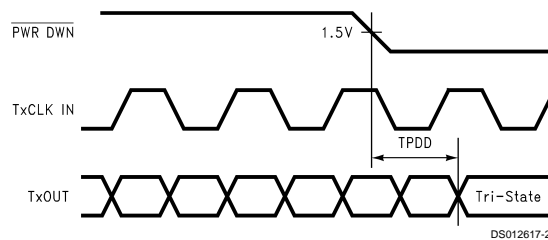

DS012617-21

FIGURE 18. Transmitter Powerdown Delay

DS90CR563 Pin Descriptions—FPD Link Transmitter

Pin Name	I/O	No.	Description
TxIN	I	21	TTL level input. This includes: 6 Red, 6 Green, 6 Blue, and 3 control lines— FPLINE, FPFFRAME, DRDY(also referred to as HSYNC, VSYNC, Data Enable)
TxOUT+	O	3	Positive LVDS differential data output
TxOUT-	O	3	Negative LVDS differential data output
FPSHIFT IN	I	1	TTL level clock input. The falling edge acts as data strobe
TxCLK OUT+	O	1	Positive LVDS differential clock output
TxCLK OUT-	O	1	Negative LVDS differential clock output
PWR DOWN	I	1	TTL level input. Assertion (low input) TRI-STATES the outputs, ensuring low current at power down
V _{CC}	I	4	Power supply pins for TTL inputs
GND	I	5	Ground pins for TTL inputs
PLL V _{CC}	I	1	Power supply pin for PLL

DS90CR563 Pin Descriptions— FPD Link Transmitter (Continued)

Pin Name	I/O	No.	Description
PLL GND	I	2	Ground pins for PLL
LVDS V _{CC}	I	1	Power supply pin for LVDS outputs
LVDS GND	I	3	Ground pins for LVDS outputs

DS90CR564 Pin Descriptions— FPD Link Receiver

Pin Name	I/O	No.	Description
RxIN+	I	3	Positive LVDS differential data inputs
RxIN-	I	3	Negative LVDS differential data inputs
RxOUT	O	21	TTL level data outputs. This includes: 6 Red, 6 Green, 6 Blue, and 3 control lines— FPLINE, FPF _{FRAME} , DRDY (also referred to as HSYNC, VSYNC, Data Enable)
RxCLK IN+	I	1	Positive LVDS differential clock input
RxCLK IN-	I	1	Negative LVDS differential clock input
FPSHIFT OUT	O	1	TTL level clock output. The falling edge acts as data strobe
PWR DOWN	I	1	TTL level input. Assertion (low input) maintains the receiver outputs in the previous state
V _{CC}	I	4	Power supply pins for TTL outputs
GND	I	5	Ground pins for TTL outputs
PLL V _{CC}	I	1	Power supply for PLL
PLL GND	I	2	Ground pin for PLL
LVDS V _{CC}	I	1	Power supply pin for LVDS inputs
LVDS GND	I	3	Ground pins for LVDS inputs

Connection Diagrams

