

DSA60C45HB

45 V, 2 x 30 A High-Performance Schottky Diode

Low Loss and Soft Recovery Common Cathode

RoHS

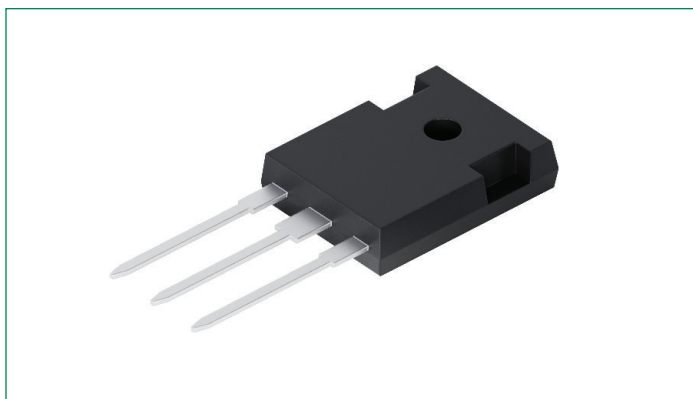

Features

- Extremely low switching losses
- Very low V_F

Benefits

- Low voltage peaks for reduced protection circuits
- High reliability circuit operation
- Low-noise switching
- Improved thermal behavior
- Longer lifetime of the system

Applications

- Rectifiers in Switch Mode Power Supplies (SMPS)
- Free wheeling diode in low voltage converters

Package

- RoHS compliant
- Epoxy meets UL 94V-0
- Industry standard outline

Product Summary

Characteristic	Value	Unit
V_{RRM}	45	V
$I_{F(AV)}$	2 x 30	A
V_F	0.71	V

Pinout Diagram (TO-247)

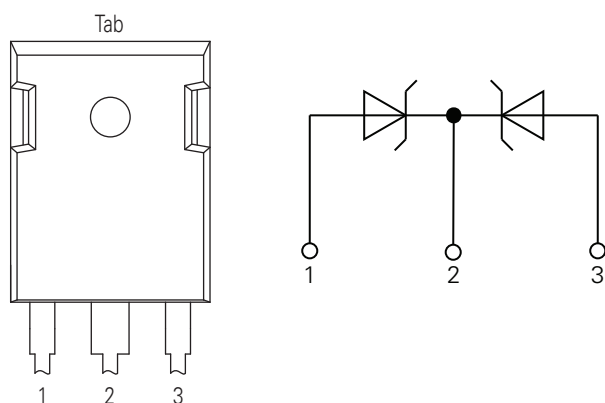

1: Anode; **2:** Cathode ; **3:** Anode; **Tab:** Cathode

Maximum Ratings

Symbol	Characteristics	Condition	Value	Units
V_{RSM}	Non-repetitive Reverse Blocking Voltage	$T_{vj} = 25\text{ }^{\circ}\text{C}$	45	V
V_{RRM}	Repetitive Reverse Blocking Voltage	$T_{vj} = 25\text{ }^{\circ}\text{C}$	45	V
$I_{F(AV)}$	Average Forward Current	$T_c = 159\text{ }^{\circ}\text{C}, T_{vj} = 175\text{ }^{\circ}\text{C},$ Rectangular $d = 0.5$	30	A
I_{FSM}	Non-repetitive Forward Surge Current	$t = 10\text{ ms}, (50\text{ Hz}), \text{ half sine}, T_{vj} = 45\text{ }^{\circ}\text{C}$	450	A
$V_{(FO)}$	Threshold Voltage	$T_{vj} = 175\text{ }^{\circ}\text{C}$	0.41	V
r_F	Slope Resistance		4.8	m Ω
P_{tot}	Total Power Dissipation	$T_c = 25\text{ }^{\circ}\text{C}$	168	W
T_{stg}	Storage Temperature Range	–	-55 to +150	$^{\circ}\text{C}$
T_{vj}	Virtual Junction Temperature Range	–	-55 to +175	$^{\circ}\text{C}$
T_{op}	Operating Temperature Range	–	-55 to +150	$^{\circ}\text{C}$

Electrical Characteristics – Static

Symbol	Characteristics	Conditions	Value			Units
			Min.	Typ.	Max.	
I_R	Reverse Current	$V_R = 45\text{ V}, T_{vj} = 25\text{ }^{\circ}\text{C}$	–	–	0.6	mA
		$V_R = 45\text{ V}, T_{vj} = 125\text{ }^{\circ}\text{C}$	–	–	21	
V_F	Forward Voltage	$I_F = 30\text{ A}; \text{ Pulse}, T_{vj} = 25\text{ }^{\circ}\text{C}$	–	–	0.77	V
		$I_F = 60\text{ A}; \text{ Pulse}, T_{vj} = 25\text{ }^{\circ}\text{C}$	–	–	0.96	
		$I_F = 30\text{ A}; \text{ Pulse}, T_{vj} = 125\text{ }^{\circ}\text{C}$	–	–	0.71	
		$I_F = 60\text{ A}; \text{ Pulse}, T_{vj} = 125\text{ }^{\circ}\text{C}$	–	–	0.88	
C_j	Junction Capacitance	$V_R = 5\text{ V}, f = 1\text{ MHz}, T_{vj} = 25\text{ }^{\circ}\text{C}$	–	990	–	pF

Thermal Specifications

Symbol	Characteristics	Value			Units
		Min.	Typ.	Max.	
$R_{th(j-c)}$	Thermal Resistance, Junction to Case	–	–	0.9	K/W
$R_{th(c-h)}$	Thermal Resistance, Case to Heatsink	–	0.3	–	K/W

Package (TO-247)

Symbol	Characteristics	Conditions	Value			Units
			Min.	Typ.	Max.	
I_{tRMS}	RMS Current	per terminal	–	–	50	A
M_s	Mounting Torque for Screw to Heatsink	–	0.8	–	1.2	Nm
F_C	Mounting Force with Clip	–	20	–	120	N
G	Weight	–	–	6	–	g

Characteristic Curves

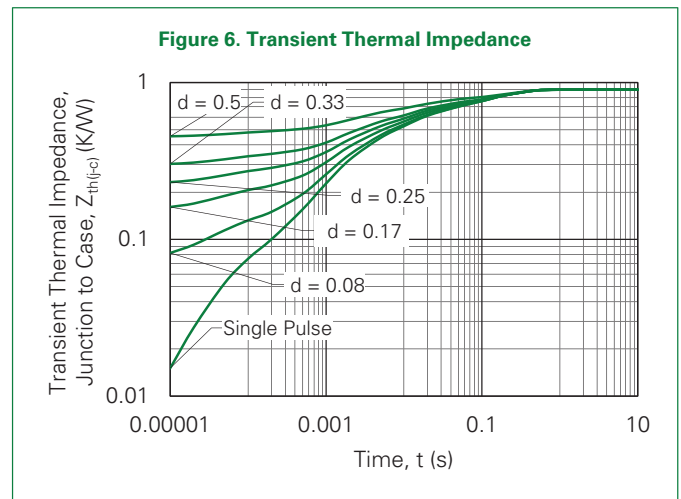
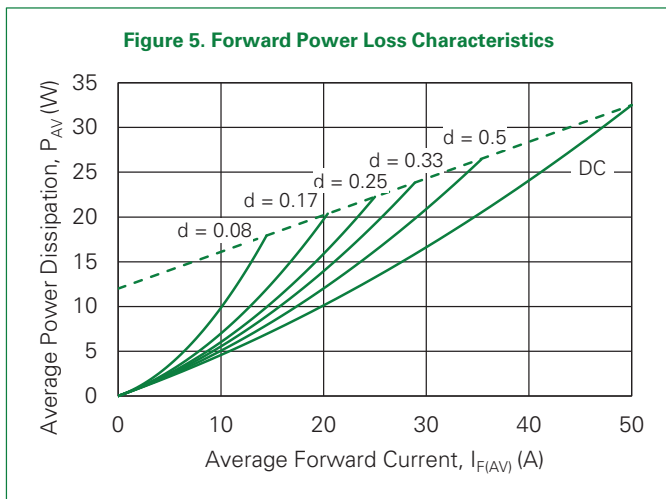
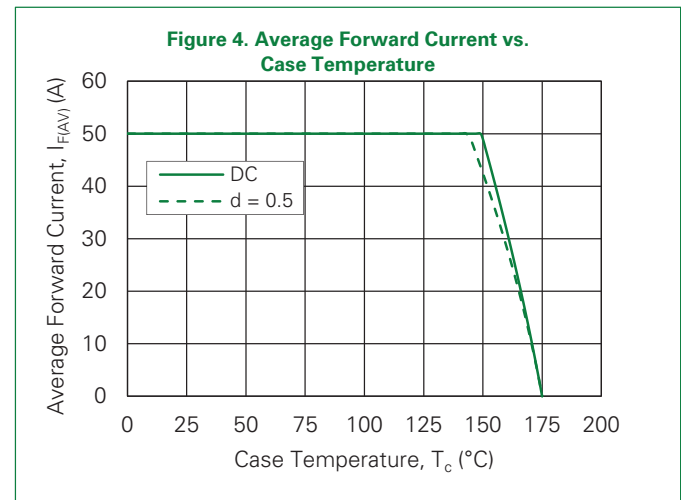
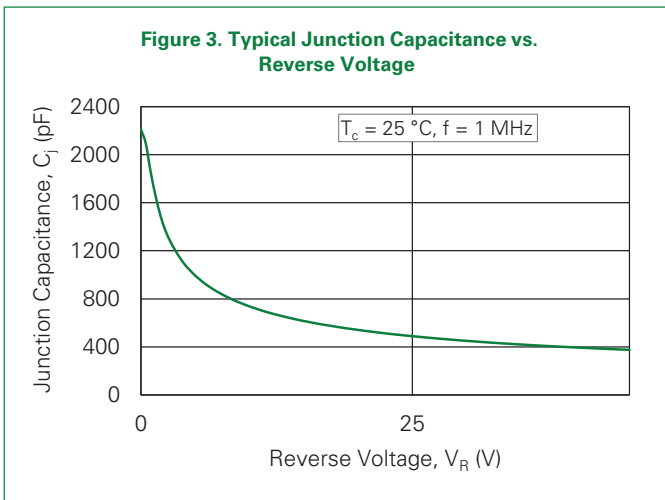
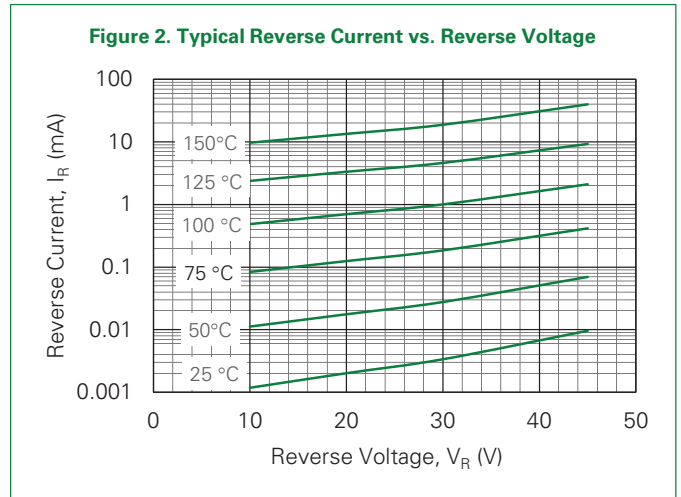
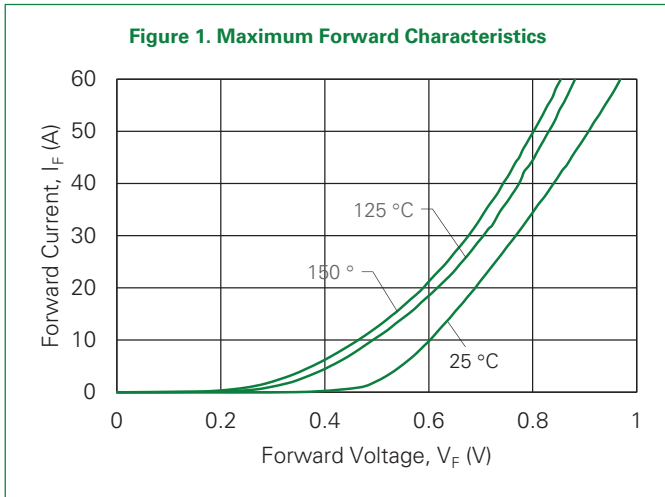

Part Outline Drawing (TO-247)

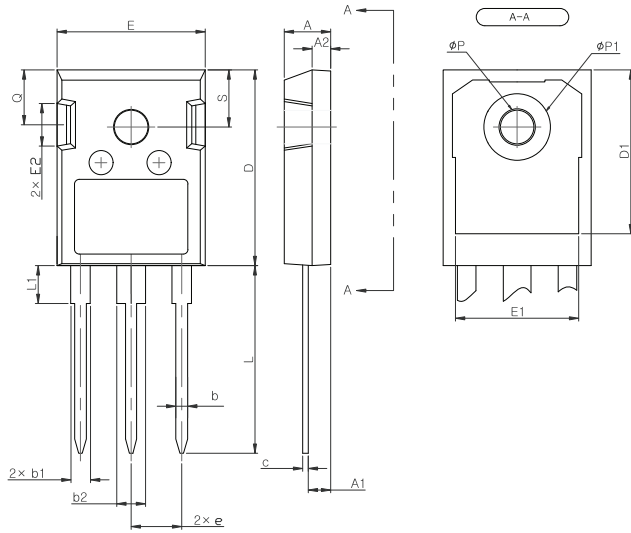

Symbol	Inches		Millimeters	
	Min.	Max.	Min.	Max.
A	0.189	0.205	4.80	5.20
A1	0.090	0.10	2.29	2.54
A2	0.075	0.083	1.90	2.10
b	0.043	0.051	1.10	1.30
b1	0.075	0.087	1.91	2.20
b2	0.115	0.126	2.92	3.20
c	0.020	0.027	0.50	0.70
D	0.819	0.840	20.80	21.34
D1	0.686	0.702	17.43	17.83
E	0.620	0.635	15.75	16.13
E1	0.514	0.530	13.06	13.46
E2	0.170	0.190	4.32	4.83
e	0.215 BSC		5.45 BSC	
L	0.781	0.797	19.85	20.25
L1	–	0.177	–	4.49
Ø P	0.140	0.144	3.55	3.65
Ø P1	0.281-	0.285	7.14	7.24
Q	0.220	0.244	5.59	6.19
S	0.242 BSC		6.15 BSC	

Part Number and Marking

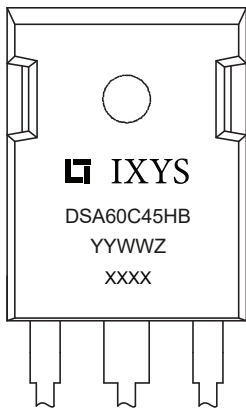

- D = Diode
- S = Schottky Diode
- A = Low V_F
- 60 = Current (2 x 30 A)
- C = Common Cathode
- 45 = Voltage (45 V)
- HB = Package (TO-247)
- YY = Year
- WW = Work Week
- Z = Plant Location Code
- xxxx = Lot Number

Ordering Information

Part Number	Marking	Packing Mode	Quantity
DSA60C45HB	DSA60C45HB	Tube	30 pcs/ tube

Disclaimer Notice

Information furnished is believed to be accurate and reliable. However, users should independently evaluate the suitability of and test each product selected for their own applications. Littelfuse products are not designed for, and may not be used in, all applications. Read complete Disclaimer Notice at <http://www.littelfuse.com/disclaimer-electronics>.



Part of:

