



## General Description

The DSC2122 and DSC2222 series of programmable, high-performance dual LVPECL oscillators utilizes a proven silicon MEMS technology to provide excellent jitter and stability while incorporating high output frequency flexibility. DSC2122 and DSC2222 allow the user to independently modify the frequency of each output using I<sup>2</sup>C or SPI interface, respectively. User can also select from two pre-programmed default output frequencies using the control pin.

DSC2122 and DSC2222 are packaged in 14-pin 3.2x2.5 mm QFN packages and available in temperature grades from Ext. Commercial to Industrial.

## Block Diagram

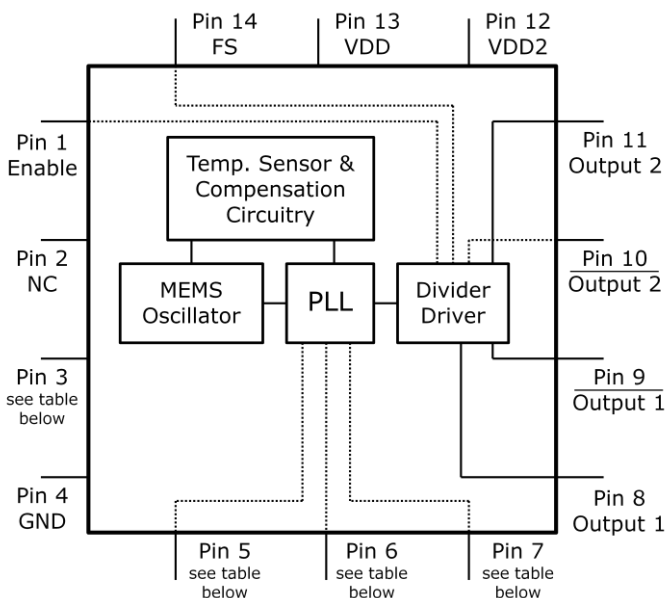

Pin #	DSC2122 (I <sup>2</sup> C)	DSC2222 (SPI)
3	NC	SCLK
5	SDA	MOSI
6	SCL	MISO
7	CS_bar	SS

## Features

- **Low RMS Phase Jitter: <1 ps (typ)**
- **High Stability: ±50 ppm**
- **Wide Temperature Range**
  - Industrial: -40° to 85° C
  - Ext. commercial: -20° to 70° C
- **High Supply Noise Rejection: -50 dBc**
- **Two Independent LVPECL Outputs**
- **I<sup>2</sup>C/SPI Programmable Frequencies**
- **Short Lead Times: 2 Weeks**
- **Wide Frequency Range:**
  - LVPECL Output: 2.3 to 460 MHz
- **Miniature Footprint of 3.2x2.5mm**
- **Excellent Shock & Vibration Immunity**
  - Qualified to MIL-STD-883
- **High Reliability**
  - 20x better MTF than quartz oscillators
- **Supply Range of 2.25 to 3.6 V**
- **Lead Free & RoHS Compliant**

## Applications

- **Storage Area Networks**
  - SATA, SAS, Fibre Channel
- **Passive Optical Networks**
  - EPON, 10G-EPON, GPON, 10G-PON
- **Ethernet**
  - 1G, 10GBASE-T/KR/LR/SR, and FCoE
- **HD/SD/SDI Video & Surveillance**
- **PCI Express**

## Pin Description

Pin No.	Pin Name	Pin Type	Description
1	Enable	I	Enables outputs when high and disables when low
2	NC	NA	Leave unconnected or grounded
3	NC	NA	DSC2122: Leave unconnected or grounded
	SCLK	I	DSC2222: Serial clock from master
4	GND	Power	Ground
5	SDA	I	DSC2122: I <sup>2</sup> C Serial Data
	MOSI		DSC2222: SPI Serial Data from Master to Slave
6	SCL	I	DSC2122: I <sup>2</sup> C Serial Clock
	MISO	O	DSC2222: SPI Serial Data from Slave to Master
7	CS_bar	I	DSC2122: I <sup>2</sup> C Chip Select (Active Low)
	SS	I	DSC2222: SPI Slave Select (Active Low)
8	Output1+	O	Positive LVPECL Output 1
9	Output1-	O	Negative LVPECL Output 1
10	Output 2-	O	Negative LVPECL Output 2
11	Output 2+	O	Positive LVPECL Output 2
12	VDD2	Power	Power Supply for LVPECL Output 2
13	VDD	Power	Power Supply
14	FS	I	Default output clock frequency bit

## Operational Description

The DSC2122/2222 is a dual LVPECL oscillator consisting of a MEMS resonator and a support PLL IC. The outputs are generated through independent 8-bit programmable dividers from the output of the internal PLL.

DSC2122/2222 allows for easy programming of the output frequencies using I<sup>2</sup>C/SPI interface. Upon power-up, the initial output frequencies are controlled by an internal pre-programmed memory (OTP). This memory stores all coefficients required by the PLL for two different default frequency pairs. The

control pin (FS) selects the initial pair. Once the device is powered up, a new output frequency pair can be programmed. Programming details are provided in the **Programming Guide**. Standard default frequency pairs are described in the following sections. Discera supports customer defined versions of the DSC2122/2222.

When Enable (pin 1) is floated or connected to VDD, the DSC2122/2222 is in operational mode. Driving Enable to ground will tri-state both output drivers (hi-impedance mode).

## Output Clock Frequencies

Table 1 lists the standard default frequency configurations and the associated ordering information to be used in conjunction with the ordering code. Customer defined combinations are available.

Table 1. Pre-programmed pin-selectable output frequency pairs

Ordering Info	Freq (MHz)	Select Bit [FS] - <b>Default is [1]</b>	
		0	1
F0001	f <sub>OUT1</sub>	106.25	<b>100</b>
	f <sub>OUT2</sub>	25	<b>100</b>
F0002	f <sub>OUT1</sub>	156.25	<b>0*</b>
	f <sub>OUT2</sub>	25	<b>0*</b>
F0003	f <sub>OUT1</sub>	150	<b>0*</b>
	f <sub>OUT2</sub>	150	<b>0*</b>
FXXXX	f <sub>OUT1</sub>	Contact factory for additional configurations.	
	f <sub>OUT2</sub>		

Frequency select bit are weakly tied high so if left unconnected the default setting will be [1] and the device will output the associated frequency highlighted in **Bold**.

0\* – denotes invalid selection, output frequency is not specified.

## Absolute Maximum Ratings

Item	Min	Max	Unit	Condition		
Supply Voltage	-0.3	+4.0	V			
Input Voltage	-0.3	V <sub>DD</sub> +0.3	V			
Junction Temp	-	+150	°C			
Storage Temp	-55	+150	°C			
Soldering Temp	-	+260	°C	40sec max.		
ESD	-		V			
					HBM	4000
					MM	400
CDM	1500					

Note: 1000+ years of data retention on internal memory

## Ordering Code

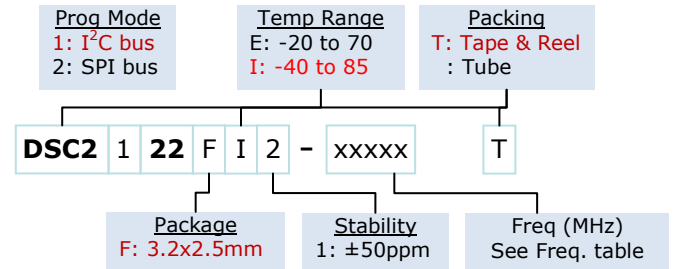

## Specifications (Unless specified otherwise: T=25° C)

Parameter	Condition	Min.	Typ.	Max.	Unit
Supply Voltage <sup>1</sup>	V <sub>DD</sub>	2.25		3.6	V
Supply Current	I <sub>DD</sub> EN pin low – outputs are disabled		21	23	mA
Supply Current <sup>2</sup>	I <sub>DD</sub> EN pin high – outputs are enabled R <sub>L</sub> =50Ω, F <sub>O1</sub> =F <sub>O2</sub> =156.25 MHz		89		mA
Frequency Stability	Δf Includes frequency variations due to initial tolerance, temp. and power supply voltage			±50	ppm
Aging	Δf 1 year @25°C			±5	ppm
Startup Time <sup>3</sup>	t <sub>SU</sub> T=25°C			5	ms
Input Logic Levels	V <sub>IH</sub> V <sub>IL</sub>	0.75xV <sub>DD</sub> -		- 0.25xV <sub>DD</sub>	V
Input logic high					
Input logic low					
Output Disable Time <sup>4</sup>	t <sub>DA</sub>			5	ns
Output Enable Time	t <sub>EN</sub>			20	ns
Pull-Up Resistor <sup>2</sup>	Pull-up exists on all digital IO		40		kΩ
LVPECL Outputs					
Output Logic Levels	V <sub>OH</sub> V <sub>OL</sub>	R <sub>L</sub> =50Ω	V <sub>DD</sub> -1.08 -	- V <sub>DD</sub> -1.55	V
Output logic high					
Output logic low					
Pk to Pk Output Swing		Single-Ended		800	mV
Output Transition time <sup>4</sup>	t <sub>R</sub> t <sub>F</sub>	20% to 80% R <sub>L</sub> =50Ω		250	ps
Rise Time					
Fall Time					
Frequency	f <sub>0</sub>	Single Frequency	2.3	460	MHz
Output Duty Cycle	SYM	Differential	48	52	%
Period Jitter <sup>5</sup>	J <sub>PER</sub>	F <sub>O1</sub> =F <sub>O2</sub> =156.25 MHz		2.5	ps <sub>RMS</sub>
Integrated Phase Noise	J <sub>PH</sub>	200kHz to 20MHz @156.25MHz		0.25	
		100kHz to 20MHz @156.25MHz		0.38	
		12kHz to 20MHz @156.25MHz		1.7	2

### Notes:

- Pin 4 V<sub>DD</sub> should be filtered with 0.01μf capacitor.
- Output is enabled if Enable pad is floated or not connected.
- t<sub>SU</sub> is time to 100PPM stable output frequency after V<sub>DD</sub> is applied and outputs are enabled.
- Output Waveform and Test Circuit figures below define the parameters.
- Period Jitter includes crosstalk from adjacent output.

## Nominal Performance Parameters (Unless specified otherwise: T=25° C, V<sub>DD</sub>=3.3 V)

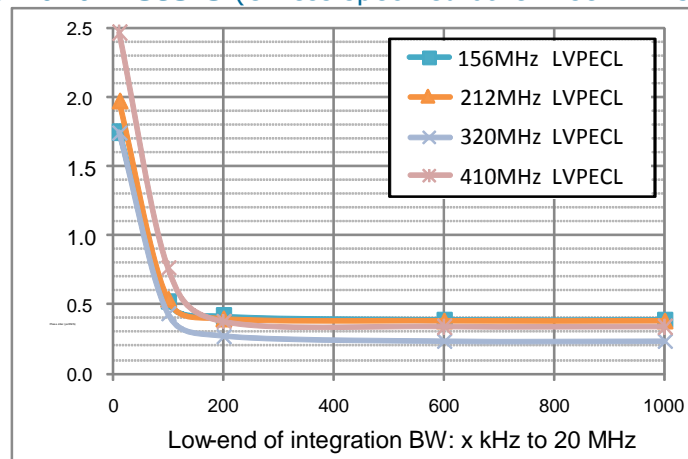

LVPECL Phase jitter (integrated phase noise)

## Output Waveform: LVPECL

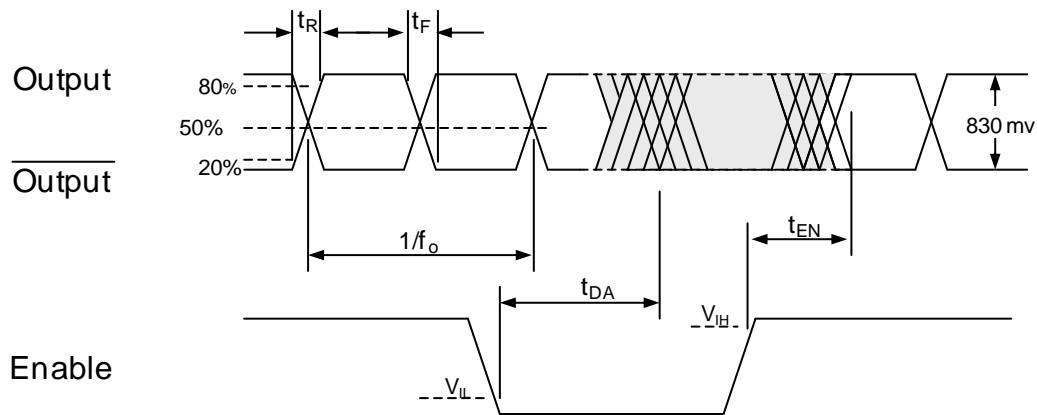

## Solder Reflow Profile

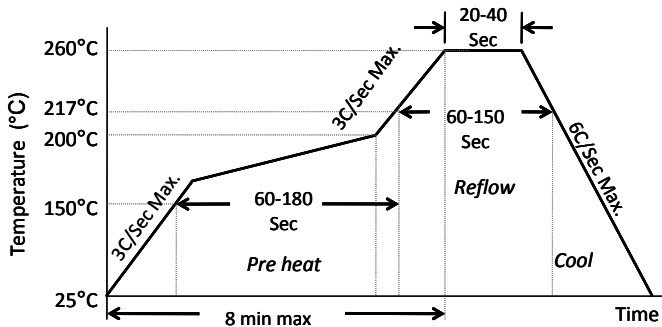

MSL 1 @ 260°C refer to JSTD-020C	
Ramp-Up Rate (200°C to Peak Temp)	3°C/Sec Max.
Preheat Time 150°C to 200°C	60-180 Sec
Time maintained above 217°C	60-150 Sec
Peak Temperature	255-260°C
Time within 5°C of actual Peak	20-40 Sec
Ramp-Down Rate	6°C/Sec Max.
Time 25°C to Peak Temperature	8 min Max.

## Package Dimensions

### 3.2 x 2.5 mm 14 Lead Plastic Package

#### External Dimensions

units: mm[inch]

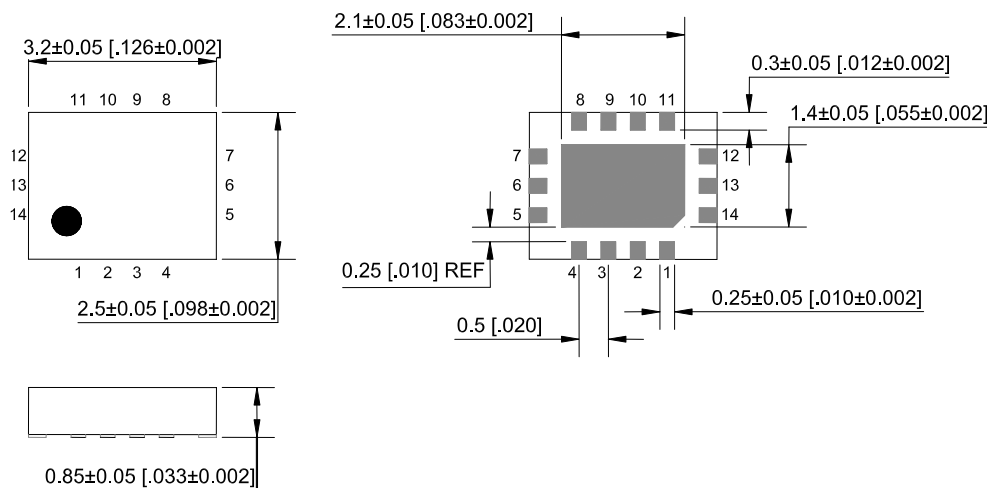

#### Recommended Solder Pad Layout

units: mm[inch]

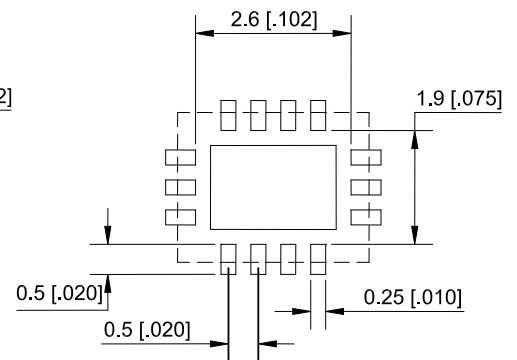

## Disclaimer:

Discera makes no warranty of any kind, express or implied, with regard to this material, including, but not limited to, the implied warranties of merchantability and fitness for a particular purpose. Discera reserves the right to make changes without further notice to materials described herein. Discera does not assume any liability arising from the application or use of any product or circuit described herein. Discera does not authorize its products for use a critical components in life-support systems where a malfunction or failure may reasonably be expected to result in significant injury to the user. The inclusion of Discera's product in a life-support systems application implies that the manufacturer assumes all risk of such use and in doing so indemnifies Discera against all charges.