

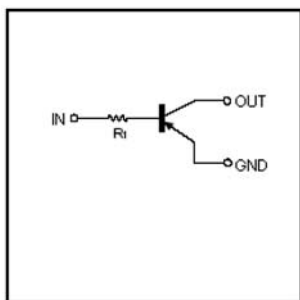

RoHS Compliant Product
A suffix of "-C" specifies halogen & lead-free

FEATURES

- Built-in bias resistors enable the configuration of an inverter circuit without connecting external input resistors.
- The bias resistors consist of thin-film resistors with complete isolation to allow positive biasing of the input. They also have the advantage of almost completely eliminating parasitic effects.
- Only the on/off conditions need to be set for operation, making device design easy.

EQUIVALENT CIRCUIT

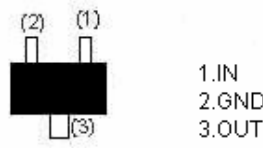
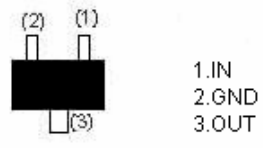
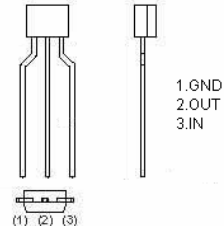

<p>DTA114TE (SOT-523)</p>  <p>1.IN 2.GND 3.OUT</p> <p>Abbreviated symbol : 94</p>	<p>DTA114TUA (SOT-323)</p>  <p>1.IN 2.GND 3.OUT</p> <p>Abbreviated symbol : 94</p>
<p>DTA114TSA (TO-92S)</p>  <p>1.GND 2.OUT 3.IN</p> <p>Abbreviated symbol : 94</p>	<p>DTA114TCA (SOT-23)</p>  <p>1.IN 2.GND 3.OUT</p> <p>Abbreviated symbol : 94</p>

ABSOLUTE MAXIMUM RATINGS at (T_A = 25°C unless otherwise noted)

Parameter	Symbol	LIMITS(DTA114T□)				Unit
		E	UA	CA	SA	
Collector-Base Voltage	V _{CB0}	-50				V
Collector-Emitter Voltage	V _{CE0}	-50				V
Emitter-Base Voltage	V _{EBO}	-5				mA
Collector Current-Continuous	I _C	-100				
Collector Dissipation	P _C	150	200	300	mW	
Junction & Storage temperature	T _J , T _{STG}	150, -55~150				°C

ELECTRICAL CHARACTERISTICS at (T_A = 25°C unless otherwise noted)

Parameter	Symbol	Min.	Typ.	Max.	Unit	Test Conditions
Collector-base breakdown voltage	V _{(BR)CBO}	-50	-	-	V	I _C = -50μA, I _E = 0
Collector-emitter breakdown voltage	V _{(BR)CEO}	-50	-	-		I _C = -1mA, I _B = 0
Emitter-base breakdown voltage	V _{(BR)EBO}	-5	-	-	V	I _E = -50μA, I _C =0
Collector cut-off current	I _{CB0}	-	-	-0.5	μA	V _{CB} = -50V, I _E =0
Emitter cut-off current	I _{EBO}	-	-	-0.5	μA	V _{EB} = -4V, I _C =0
DC current gain	h _{FE}	100	250	600		V _{CE} = -5V, I _C = -1mA
Collector-emitter saturation voltage	V _{CE(sat)}	-	-	-0.3	V	I _C = -10mA, I _B = -1mA
Transition frequency	f _T	-	250	-	MHz	V _{CE} = -10V, I _C = -5mA, f= 100MHz
Input resistor	R _I	7	10	13	kΩ	

CHARACTERISTIC CURVES

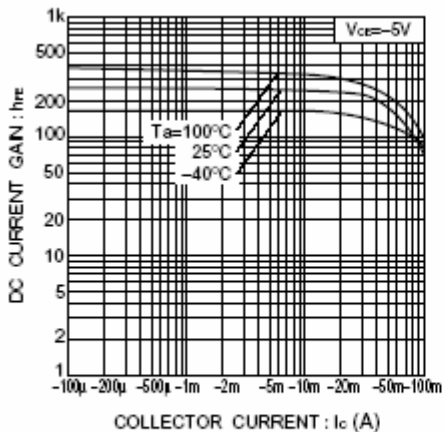

Fig.1 DC current gain vs. collector current

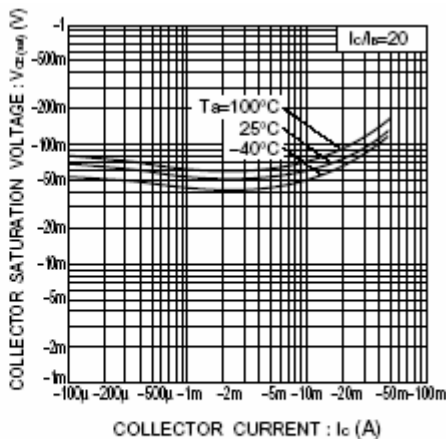

Fig.2 Collector-emitter saturation voltage vs. collector current