

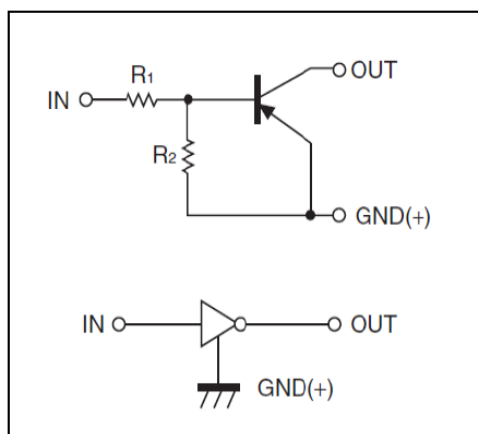

RoHS Compliant Product  
A suffix of "-C" specifies halogen & lead-free

## FEATURES

- Built-in bias resistors enable the configuration of an inverter circuit without connecting external input resistors (see equivalent circuit).
- The bias resistors consist of thin-film resistors with complete isolation to allow positive biasing of the input. They also have the advantage of almost completely eliminating parasitic effects.
- Only the on/off conditions need to be set for operation, making device design easy.

## EQUIVALENT CIRCUIT

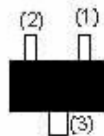

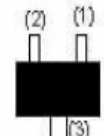
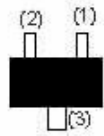
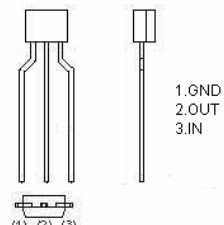
<p align="center"><b>DTA143ZE (SOT-523)</b></p>  <p align="right">1.IN 2.GND 3.OUT</p> <p align="center">Abbreviated symbol : E13</p>	<p align="center"><b>DTA143ZUA(SOT-323)</b></p>  <p align="right">1.IN 2.GND 3.OUT</p> <p align="center">Abbreviated symbol : 113</p>
<p align="center"><b>DTA143ZM (SOT-723)</b></p>  <p align="right">1.IN 2.GND 3.OUT</p> <p align="center">Abbreviated symbol : E13</p>	<p align="center"><b>DTA143ZCA (SOT-23)</b></p>  <p align="right">1.IN 2.GND 3.OUT</p> <p align="center">Abbreviated symbol : E13</p>
<p align="center"><b>DTA143ZSA (TO-92S)</b></p>  <p align="right">1.GND 2.OUT 3.IN</p>	

## ABSOLUTE MAXIMUM RATINGS (T<sub>A</sub>=25°C unless otherwise noted)

Parameter	Symbol	Limits (DTA143Z□)					Unit
		M	E	UA	CA	SA	
Supply Voltage	V <sub>CC</sub>			-50			V
Input voltage	V <sub>IN</sub>			-30 ~ 5			V
Output current	I <sub>O</sub>			-100			mA
Power dissipation	P <sub>D</sub>	100	150	200		300	mW
Junction & Storage temperature	T <sub>J</sub> , T <sub>STG</sub>			150, -55~150			°C

**ELECTRICAL CHARACTERISTICS** ( $T_A=25^\circ\text{C}$  unless otherwise noted)

Parameter	Symbol	Min.	Typ.	Max.	Unit	Test Conditions
Input voltage	$V_{I(off)}$	-0.5	-	-	V	$V_{CC} = -5\text{V}$ , $I_O = -100\mu\text{A}$
	$V_{I(on)}$	-	-	-1.3		$V_O = -0.3\text{V}$ , $I_O = -5\text{mA}$
Output voltage	$V_{O(on)}$	-	-	-0.3	V	$I_O/I_I = -5\text{mA}/-0.25\text{mA}$
Input current	$I_I$	-	-	-1.8	mA	$V_I = -5\text{V}$
Output current	$I_{O(off)}$	-	-	-0.5	$\mu\text{A}$	$V_{CC} = -50\text{V}$ , $V_I = 0$
DC current gain	$G_I$	80	-	-		$V_O = -5\text{V}$ , $I_O = -10\text{mA}$
Input resistance	$R_1$	3.29	4.7	6.11	K $\Omega$	
Resistance ratio	$R_2/R_1$	8	10	12		
Transition frequency	$f_T$	-	250	-	MHz	$V_O = -10\text{V}$ , $I_O = -5\text{mA}$ , $f = 100\text{MHz}$

**CHARACTERISTIC CURVES**

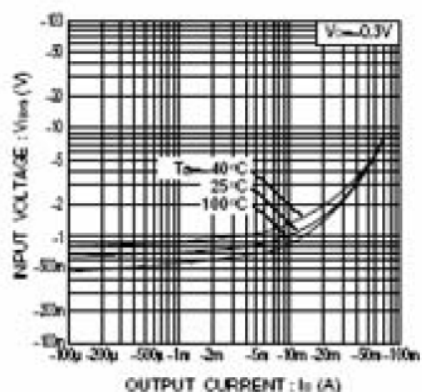

Fig.1 Input voltage vs. output current (ON characteristics)

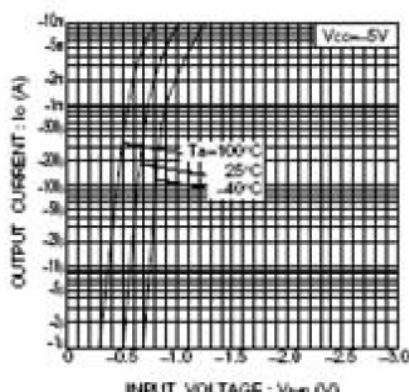

Fig.2 Output current vs. input voltage (OFF characteristics)

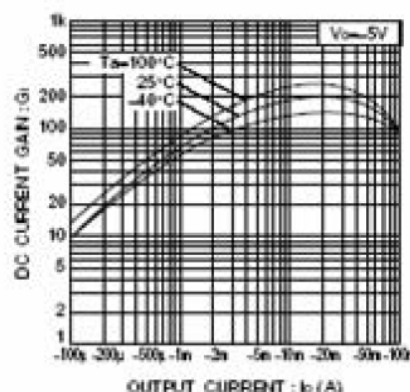

Fig.3 DC current gain vs. output current

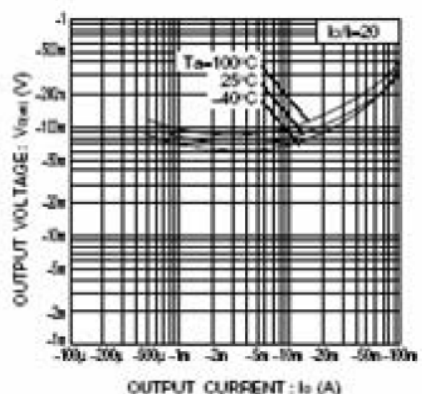

Fig.4 Output voltage vs. output current