

## Features

1. Built-in bias resistors enable the configuration of an inverter circuit without connecting external input resistors (see equivalent circuit).
2. The bias resistors consist of thin-film resistors with complete isolation to allow negative biasing of the input. They also have the advantage of almost completely eliminating parasitic effects.
3. Only the on/off conditions need to be set for operation, making device design easy.

### ●Equivalent circuit

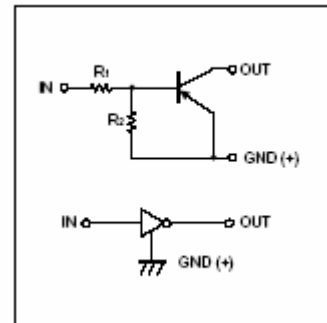

## PIN CONNENCTIONS AND MARKING

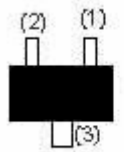
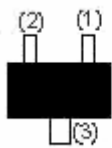
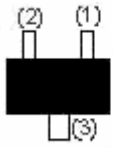
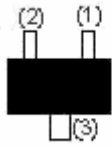
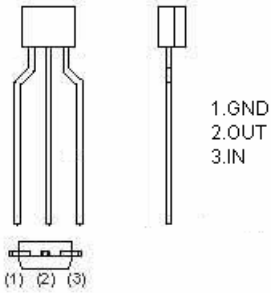
|   |  |
|---|--|
| <p>DTA144EE</p>  <p>1.IN<br/>2.GND<br/>3.OUT</p> <p>SOT-523      Abbreviated symbol: 16</p>     | <p>DTA144EUA</p>  <p>1.IN<br/>2.GND<br/>3.OUT</p> <p>SOT-323      Abbreviated symbol: 16</p> |
| <p>DTA144EKA</p>  <p>1.IN<br/>2.GND<br/>3.OUT</p> <p>SOT-23-3L      Abbreviated symbol: 16</p> | <p>DTA144ECA</p>  <p>1.IN<br/>2.GND<br/>3.OUT</p> <p>SOT-23      Abbreviated symbol: 16</p> |
| <p>DTA144ESA</p>  <p>1.GND<br/>2.OUT<br/>3.IN</p> <p>TO-92S</p>                                |  |



# DTA144EE/DTA144EUA/DTA144ECA DTA144EKA/DTA144ESA

Digital Transistor(PNP)

## Absolute maximum ratings(Ta=25°C)

| Parameter            | Symbol              | Limits (DTA144E□ ) |    |     |    |     | Unit |
|----------------------|---------------------|--------------------|----|-----|----|-----|------|
|                      |                     | E                  | UA | KA  | CA | SA  |      |
| Supply voltage       | V <sub>CC</sub>     | -50                |    |     |    |     | V    |
| Input voltage        | V <sub>IN</sub>     | -40~+10            |    |     |    |     | V    |
| Output current       | I <sub>O</sub>      | -30                |    |     |    |     | mA   |
|                      | I <sub>C(MAX)</sub> | -100               |    |     |    |     |      |
| Power dissipation    | P <sub>d</sub>      | 150                |    | 200 |    | 300 | mW   |
| Junction temperature | T <sub>J</sub>      | 150                |    |     |    |     | °C   |
| Storage temperature  | T <sub>stg</sub>    | -55~150            |    |     |    |     | °C   |

## Electrical characteristics (Ta=25°C)

| Parameter            | Symbol                         | Min. | Typ | Max.  | Unit | Conditions  |
|----------------------|--------------------------------|------|-----|-------|------|---|
| Input voltage        | V <sub>I(off)</sub>            |      |     | -0.5  | V    | V <sub>CC</sub> =-5V , I <sub>O</sub> =-100μA         |
|                      | V <sub>I(on)</sub>             | -3   |     |       |      | V <sub>O</sub> =-0.3V , I <sub>O</sub> =-2mA          |
| Output voltage       | V <sub>O(on)</sub>             |      |     | -0.3  | V    | I <sub>O</sub> /I <sub>I</sub> =-10mA/-0.5mA          |
| Input current        | I <sub>I</sub>                 |      |     | -0.18 | mA   | V <sub>I</sub> =-5V                                   |
| Output current       | I <sub>O(off)</sub>            |      |     | -0.5  | μA   | V <sub>CC</sub> =-50V , V <sub>I</sub> =0             |
| DC current gain      | G <sub>I</sub>                 | 68   |     |       |      | V <sub>O</sub> =-5V , I <sub>O</sub> =-5mA            |
| Input resistance     | R <sub>1</sub>                 | 32.9 | 47  | 61.1  | KΩ   |   |
| Resistance ratio     | R <sub>2</sub> /R <sub>1</sub> | 0.8  | 1   | 1.2   |      |   |
| Transition frequency | f <sub>T</sub>                 |      | 250 |       | MHz  | V <sub>O</sub> =-10V , I <sub>O</sub> =-5mA, f=100MHz |

## Typical Characteristics

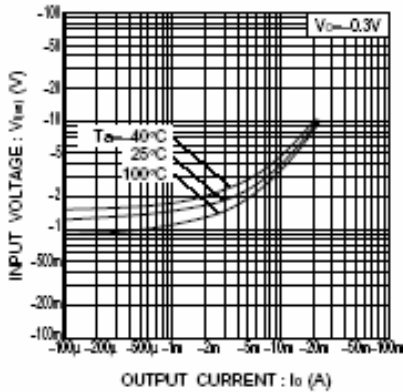

Fig.1 Input voltage vs. output current (ON characteristics)

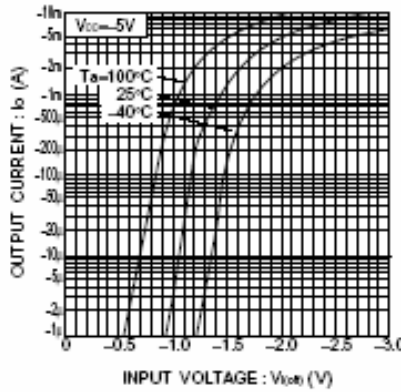

Fig.2 Output current vs. input voltage (OFF characteristics)

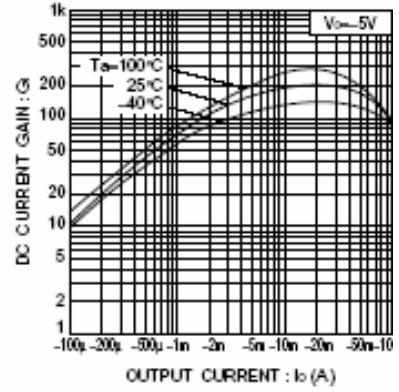

Fig.3 DC current gain vs. output current

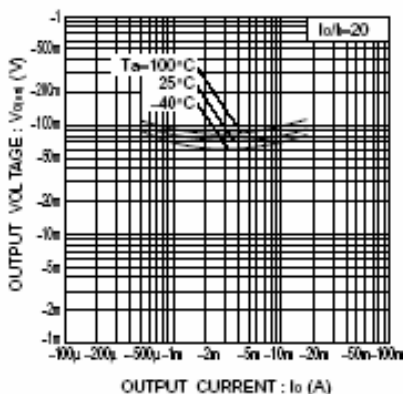

Fig.4 Output voltage vs. output current