



Digital Transistors (Built-in Resistors)

DTA144EM/DTA144EE/DTA144EUA DTA144EKA /DTA144ECA/DTA144ESA

DIGITAL TRANSISTOR (PNP)



FEATURES

- Built-in bias resistors enable the configuration of an inverter circuit without connecting external input resistors(see equivalent circuit)
- The bias resistors consist of thin-film resistors with complete isolation to allow positive biasing of the input.They also have the advantage of almost completely eliminating parasitic effects
- Only the on/off conditions need to be set for operation, making device design easy

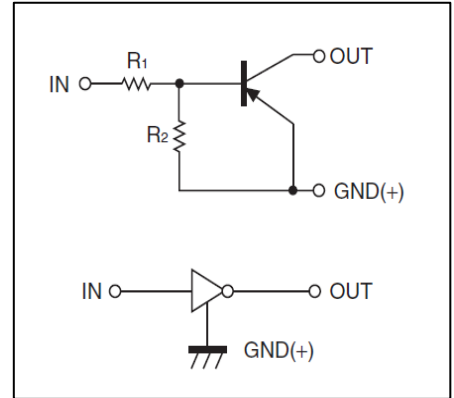
• Equivalent Circuit

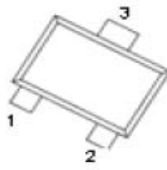
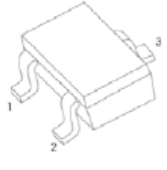
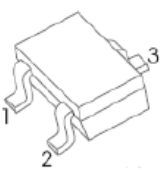
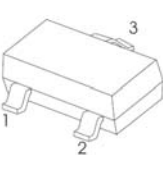
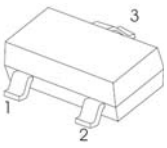

PIN CONNENCTIONS and MARKING

<p>DTA144EM</p>  <p>SOT-723</p> <p>1. IN 2. GND 3. OUT</p> <p>MARKING:16</p>	<p>DTA144EE</p>  <p>SOT-523</p> <p>1. IN 2. GND 3. OUT</p> <p>MARKING:16</p>
<p>DTA144EUA</p>  <p>SOT-323</p> <p>1. IN 2. GND 3. OUT</p> <p>MARKING:16</p>	<p>DTA144EKA</p>  <p>SOT-23-3L</p> <p>1. IN 2. GND 3. OUT</p> <p>MARKING:16</p>
<p>DTA144ECA</p>  <p>SOT-23</p> <p>1.IN 2.GND 3.OUT</p> <p>MARKING:16</p>	<p>DTA144ESA</p>  <p>TO-92S</p> <p>1. GND 2. OUT 3. IN</p>

MAXIMUM RATINGS(Ta=25°C unless otherwise noted)

Symbol	Parameter	Limits(DTA144E□)						Unit
		M	E	UA	KA	CA	SA	
V _{CC}	Supply Voltage	-50						V
V _{IN}	Input Voltage	-40~+10						V
I _O	Output Current	-30						mA
I _{CM}	Peak Collector Current	-100						mA
P _D	Power Dissipation	100	150	200	200	200	300	mW
T _J	Junction Temperature	150						°C
T _{stg}	Storage Temperature	-55~+150						°C

ELECTRICAL CHARACTERISTICS (Ta=25°C unless otherwise specified)

Parameter	Symbol	Conditions	Min	Typ	Max	Unit
Input voltage	V _{I(off)}	V _{CC} =-5V, I _O =-100μA	-0.5			V
	V _{I(on)}	V _O =-0.3V, I _O =-2 mA			-3	V
Output voltage	V _{O(on)}	I _O /I _I =-10mA/-0.5mA			-0.3	V
Input current	I _I	V _I =-5V			-0.18	mA
Output current	I _{O(off)}	V _{CC} =-50V, V _I =0			-0.5	μA
DC current gain	G _I	V _O =-5V, I _O =-5mA	68			
Input resistance	R ₁		32.9	47	61.1	kΩ
Resistance ratio	R ₂ /R ₁		0.8	1	1.2	
Transition frequency	f _T	V _O =-10V, I _O =-5mA, f=100MHz		250		MHz

Typical Characteristics

DTA144EXX

