

# DTC114EM3T5G Series

## Digital Transistors (BRT)

### NPN Silicon Surface Mount Transistors with Monolithic Bias Resistor Network

This new series of digital transistors is designed to replace a single device and its external resistor bias network. The digital transistor contains a single transistor with a monolithic bias network consisting of two resistors; a series base resistor and a base-emitter resistor. The digital transistor eliminates these individual components by integrating them into a single device. The use of a digital transistor can reduce both system cost and board space. The device is housed in the SOT-723 package which is designed for low power surface mount applications.

#### Features

- Simplifies Circuit Design
- Reduces Board Space
- Reduces Component Count
- The SOT-723 Package can be Soldered using Wave or Reflow.
- Available in 4 mm, 8000 Unit Tape & Reel
- These are Pb-Free Devices

#### MAXIMUM RATINGS (T<sub>A</sub> = 25°C unless otherwise noted)

Rating	Symbol	Value	Unit
Collector-Base Voltage	V <sub>CBO</sub>	50	Vdc
Collector-Emitter Voltage	V <sub>CEO</sub>	50	Vdc
Collector Current	I <sub>C</sub>	100	mAdc

Maximum ratings are those values beyond which device damage can occur. Maximum ratings applied to the device are individual stress limit values (not normal operating conditions) and are not valid simultaneously. If these limits are exceeded, device functional operation is not implied, damage may occur and reliability may be affected.



ON Semiconductor®

<http://onsemi.com>

### NPN SILICON DIGITAL TRANSISTORS

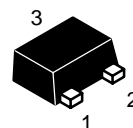
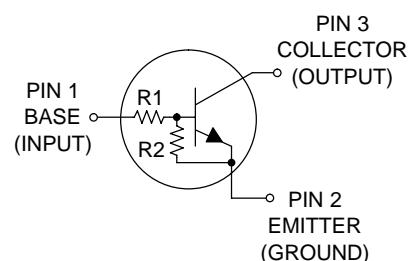

SOT-723  
CASE 631AA  
STYLE 1

#### MARKING DIAGRAM

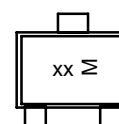

xx = Specific Device Code  
(See Marking Table on page 2)  
M = Date Code

#### ORDERING INFORMATION

See detailed ordering and shipping information in the package dimensions section on page 2 of this data sheet.

## DTC114EM3T5G Series

### DEVICE MARKING AND RESISTOR VALUES

Device	Marking	R1 (K)	R2 (K)	Package	Shipping <sup>†</sup>
DTC114EM3T5G	8A	10	10	SOT-723 (Pb-Free)	8000/Tape & Reel
DTC124EM3T5G	8B	22	22		
DTC144EM3T5G	8C	47	47		
DTC114YM3T5G	8D	10	47		
DTC114TM3T5G	8E	10	∞		
DTC143TM3T5G	8F	4.7	∞		
DTC123EM3T5G	8H	2.2	2.2		
DTC143EM3T5G	8J	4.7	4.7		
DTC143ZM3T5G*	8K	4.7	47		
DTC124XM3T5G*	8L	22	47		
DTC123JM3T5G	8M	2.2	47		
DTC115EM3T5G	8N	100	100		
DTC144WM3T5G*	8P	47	22		
DTC144TM3T5G	8T	47	∞		

<sup>†</sup>For information on tape and reel specifications, including part orientation and tape sizes, please refer to our Tape and Reel Packaging Specifications Brochure, BRD8011/D.

\*Available upon request.

### THERMAL CHARACTERISTICS

Characteristic	Symbol	Max	Unit
Total Device Dissipation, FR-4 Board (Note 1) @ T <sub>A</sub> = 25°C Derate above 25°C	P <sub>D</sub>	260 2.0	mW mW/°C
Thermal Resistance, Junction-to-Ambient (Note 1)	R <sub>θJA</sub>	480	°C/W
Total Device Dissipation, FR-4 Board (Note 2) @ T <sub>A</sub> = 25°C Derate above 25°C	P <sub>D</sub>	600 4.8	mW mW/°C
Thermal Resistance, Junction-to-Ambient (Note 2)	R <sub>θJA</sub>	205	°C/W
Junction and Storage Temperature Range	T <sub>J</sub> , T <sub>stg</sub>	-55 to +150	°C

1. FR-4 @ minimum pad.

2. FR-4 @ 1.0 × 1.0 inch pad.

## DTC114EM3T5G Series

### ELECTRICAL CHARACTERISTICS (T<sub>A</sub> = 25°C unless otherwise noted)

Characteristic	Symbol	Min	Typ	Max	Unit
<b>OFF CHARACTERISTICS</b>					
Collector–Base Cutoff Current (V <sub>CB</sub> = 50 V, I <sub>E</sub> = 0)	I <sub>CBO</sub>	–	–	100	nAdc
Collector–Emitter Cutoff Current (V <sub>CE</sub> = 50 V, I <sub>B</sub> = 0)	I <sub>CEO</sub>	–	–	500	nAdc
Emitter–Base Cutoff Current (V <sub>EB</sub> = 6.0 V, I <sub>C</sub> = 0)	I <sub>EBO</sub>	–	–	0.5	mAdc
	DTC114EM3T5G	–	–	0.2	
	DTC124EM3T5G	–	–	0.1	
	DTC144EM3T5G	–	–	0.2	
	DTC114YM3T5G	–	–	0.9	
	DTC114TM3T5G	–	–	1.9	
	DTC143TM3T5G	–	–	2.3	
	DTC123EM3T5G	–	–	1.5	
	DTC143EM3T5G	–	–	0.18	
	DTC143ZM3T5G	–	–	0.13	
	DTC124XM3T5G	–	–	0.2	
	DTC123JM3T5G	–	–	0.05	
	DTC115EM3T5G	–	–	0.13	
	DTC144WM3T5G	–	–	0.2	
	DTC144TM3T5G	–	–	–	
Collector–Base Breakdown Voltage (I <sub>C</sub> = 10 μA, I <sub>E</sub> = 0)	V <sub>(BR)CBO</sub>	50	–	–	Vdc
Collector–Emitter Breakdown Voltage (Note 3) (I <sub>C</sub> = 2.0 mA, I <sub>B</sub> = 0)	V <sub>(BR)CEO</sub>	50	–	–	Vdc
<b>ON CHARACTERISTICS (Note 3)</b>					
DC Current Gain (V <sub>CE</sub> = 10 V, I <sub>C</sub> = 5.0 mA)	h <sub>FE</sub>	35	60	–	
	DTC114EM3T5G	60	100	–	
	DTC124EM3T5G	80	140	–	
	DTC144EM3T5G	80	140	–	
	DTC114YM3T5G	160	350	–	
	DTC114TM3T5G	160	350	–	
	DTC143TM3T5G	8.0	15	–	
	DTC123EM3T5G	15	30	–	
	DTC143EM3T5G	80	200	–	
	DTC143ZM3T5G	80	150	–	
	DTC124XM3T5G	80	140	–	
	DTC123JM3T5G	80	150	–	
	DTC115EM3T5G	80	140	–	
	DTC144WM3T5G	160	350	–	
	DTC144TM3T5G	–	–	–	
Collector–Emitter Saturation Voltage (I <sub>C</sub> = 10 mA, I <sub>B</sub> = 0.3 mA) (I <sub>C</sub> = 10 mA, I <sub>B</sub> = 5 mA) DTC123EM3T5G (I <sub>C</sub> = 10 mA, I <sub>B</sub> = 1 mA) DTC143TM3T5G/DTC114TM3T5G/ DTC143EM3T5G/DTC143ZM3T5G/ DTC124XM3T5G/DTC144TM3T5G	V <sub>CE(sat)</sub>	–	–	0.25	Vdc
Output Voltage (on) (V <sub>CC</sub> = 5.0 V, V <sub>B</sub> = 2.5 V, R <sub>L</sub> = 1.0 kΩ)	V <sub>OL</sub>	–	–	0.2	Vdc
	DTC114EM3T5G	–	–	0.2	
	DTC124EM3T5G	–	–	0.2	
	DTC114YM3T5G	–	–	0.2	
	DTC114TM3T5G	–	–	0.2	
	DTC143TM3T5G	–	–	0.2	
	DTC123EM3T5G	–	–	0.2	
	DTC143EM3T5G	–	–	0.2	
	DTC143ZM3T5G	–	–	0.2	
	DTC124XM3T5G	–	–	0.2	
	DTC123JM3T5G	–	–	0.2	
(V <sub>CC</sub> = 5.0 V, V <sub>B</sub> = 3.5 V, R <sub>L</sub> = 1.0 kΩ)	DTC144EM3T5G	–	–	0.2	
	DTC144TM3T5G	–	–	0.2	
(V <sub>CC</sub> = 5.0 V, V <sub>B</sub> = 5.5 V, R <sub>L</sub> = 1.0 kΩ)	DTC115EM3T5G	–	–	0.2	
(V <sub>CC</sub> = 5.0 V, V <sub>B</sub> = 4.0 V, R <sub>L</sub> = 1.0 kΩ)	DTC144WM3T5G	–	–	0.2	

3. Pulse Test: Pulse Width < 300 μs, Duty Cycle < 2.0%.

## DTC114EM3T5G Series

### ELECTRICAL CHARACTERISTICS ( $T_A = 25^\circ\text{C}$ unless otherwise noted)

Characteristic	Symbol	Min	Typ	Max	Unit	
<b>ON CHARACTERISTICS</b> (Note 4)						
Output Voltage (off) ( $V_{CC} = 5.0\text{ V}$ , $V_B = 0.5\text{ V}$ , $R_L = 1.0\text{ k}\Omega$ ) ( $V_{CC} = 5.0\text{ V}$ , $V_B = 0.25\text{ V}$ , $R_L = 1.0\text{ k}\Omega$ )	$V_{OH}$	4.9	–	–	Vdc	
Input Resistor	DTC114EM3T5G DTC124EM3T5G DTC144EM3T5G DTC114YM3T5G DTC114TM3T5G DTC143TM3T5G DTC123EM3T5G DTC143EM3T5G DTC143ZM3T5G DTC124XM3T5G DTC123JM3T5G DTC115EM3T5G DTC144WM3T5G DTC144TM3T5G	R1	7.0 15.4 32.9 7.0 7.0 3.3 1.5 3.3 3.3 15.4 1.54 70 32.9 32.9	10 22 47 10 10 4.7 2.2 4.7 4.7 22 2.2 100 47 47	13 28.6 61.1 13 13 6.1 2.9 6.1 6.1 28.6 2.86 130 61.1 61.1	k $\Omega$
Resistor Ratio	DTC114EM3T5G/DTC124EM3T5G/ DTC144EM3T5G/DTC115EM3T5G DTC114YM3T5G DTC143TM3T5G/DTC114TM3T5G/DTC144TM3T5G DTC123EM3T5G/DTC143EM3T5G DTC143ZM3T5G DTC124XM3T5G DTC123JM3T5G DTC144WM3T5G	$R_1/R_2$	0.8 0.17 – 0.8 0.055 0.38 0.038 1.7	1.0 0.21 – 1.0 0.1 0.47 0.047 2.1	1.2 0.25 – 1.2 0.185 0.56 0.056 2.6	

4. Pulse Test: Pulse Width < 300  $\mu\text{s}$ , Duty Cycle < 2.0%.

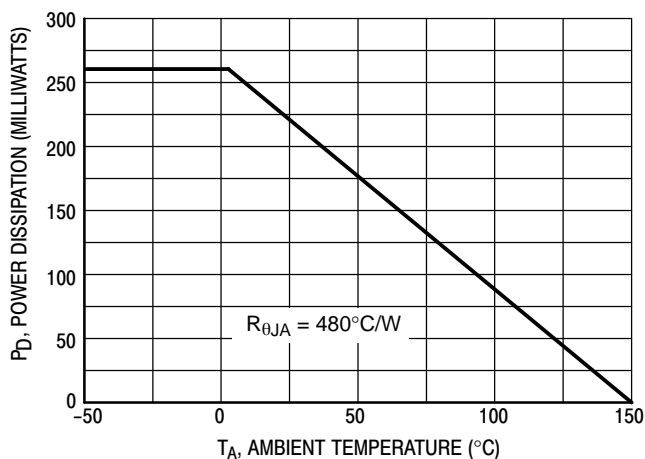

**Figure 1. Derating Curve**

# DTC114EM3T5G Series

## TYPICAL ELECTRICAL CHARACTERISTICS – DTC114EM3T5G

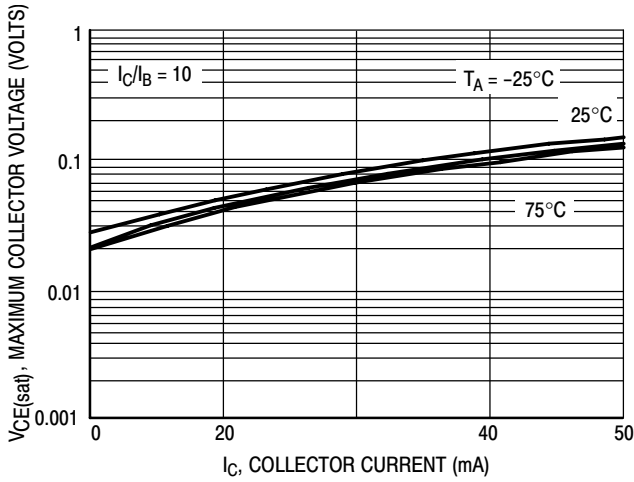

Figure 2.  $V_{CE(sat)}$  versus  $I_C$

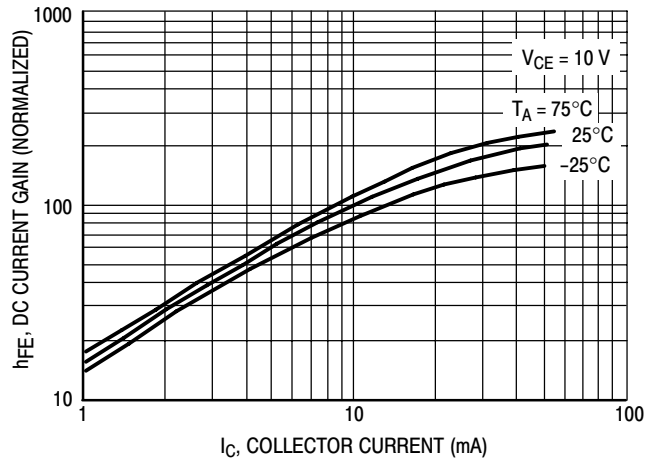

Figure 3. DC Current Gain

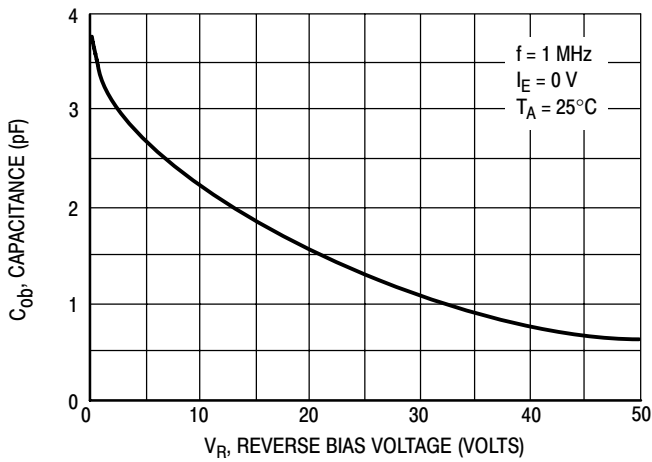

Figure 4. Output Capacitance

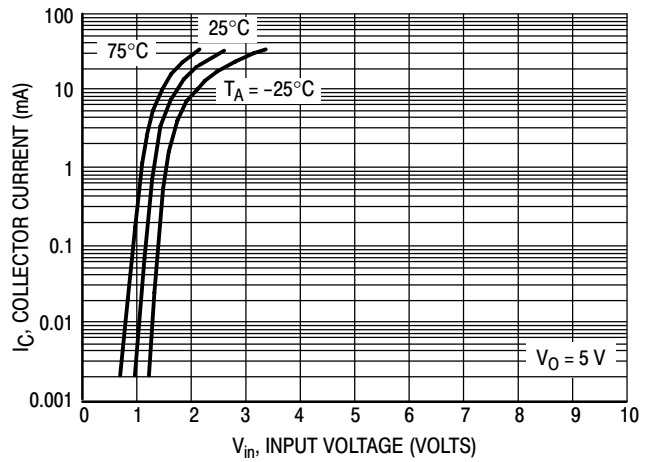

Figure 5. Output Current versus Input Voltage

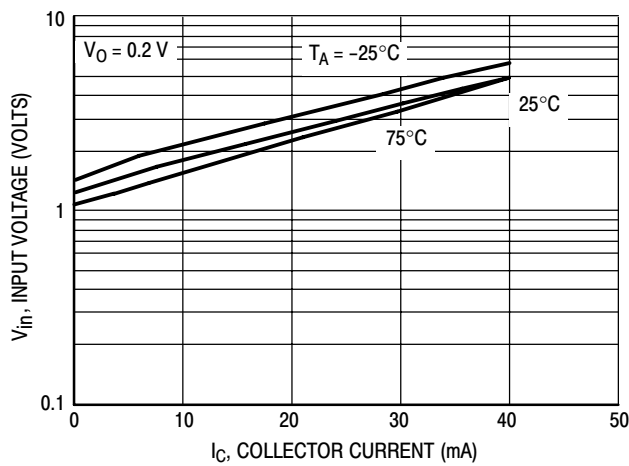

Figure 6. Input Voltage versus Output Current

# DTC114EM3T5G Series

## TYPICAL ELECTRICAL CHARACTERISTICS – DTC124EM3T5G

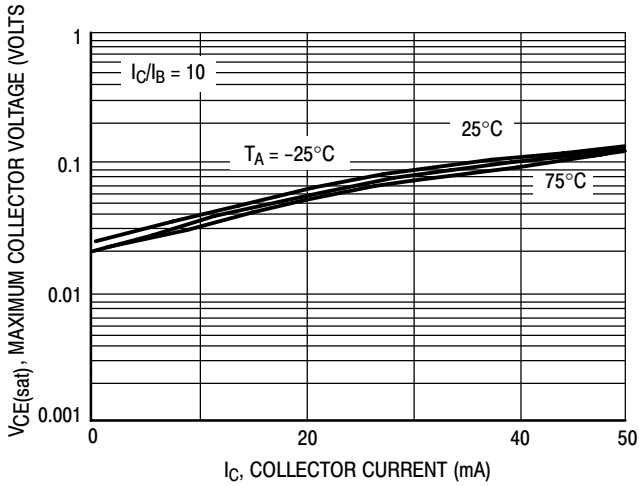

Figure 7.  $V_{CE(sat)}$  versus  $I_C$

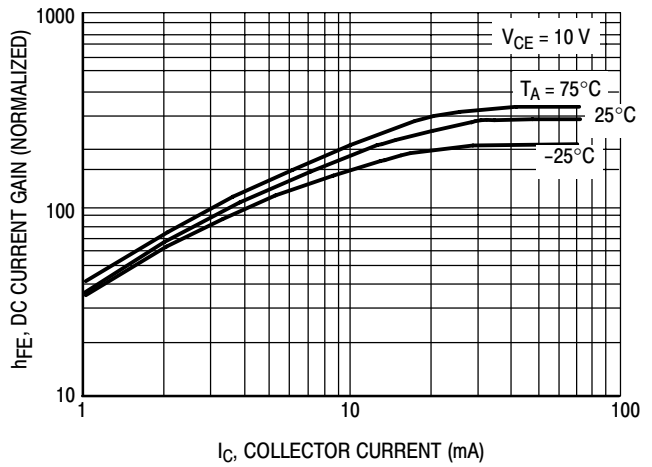

Figure 8. DC Current Gain

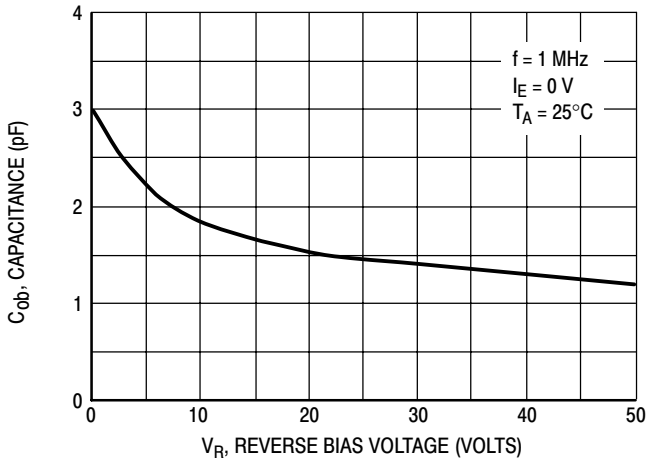

Figure 9. Output Capacitance

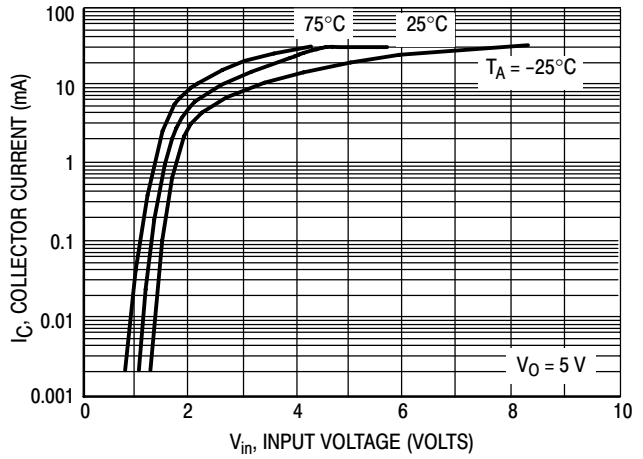

Figure 10. Output Current versus Input Voltage

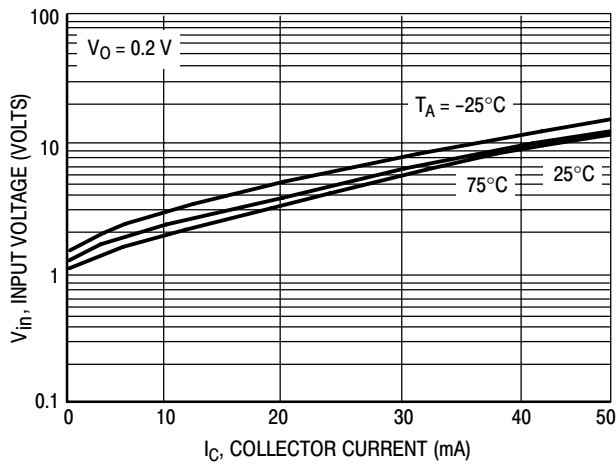

Figure 11. Input Voltage versus Output Current

# DTC114EM3T5G Series

## TYPICAL ELECTRICAL CHARACTERISTICS – DTC144EM3T5G

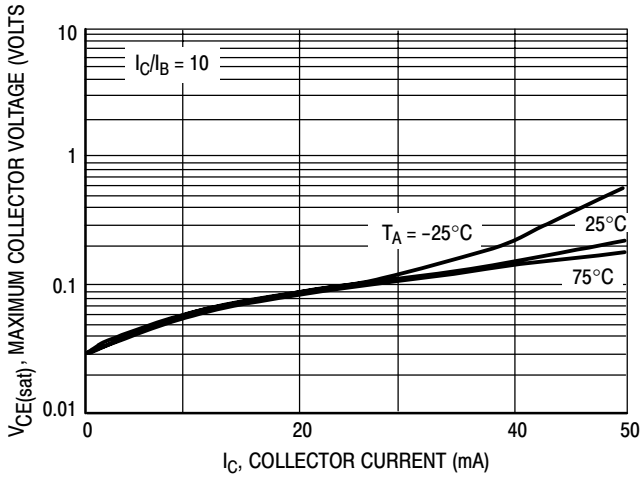

Figure 12.  $V_{CE(sat)}$  versus  $I_C$

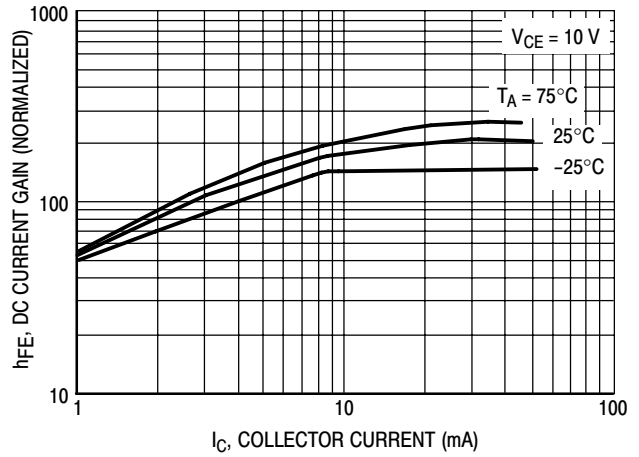

Figure 13. DC Current Gain

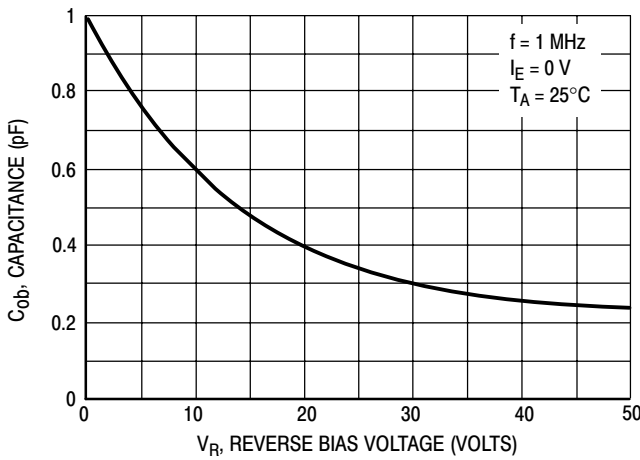

Figure 14. Output Capacitance

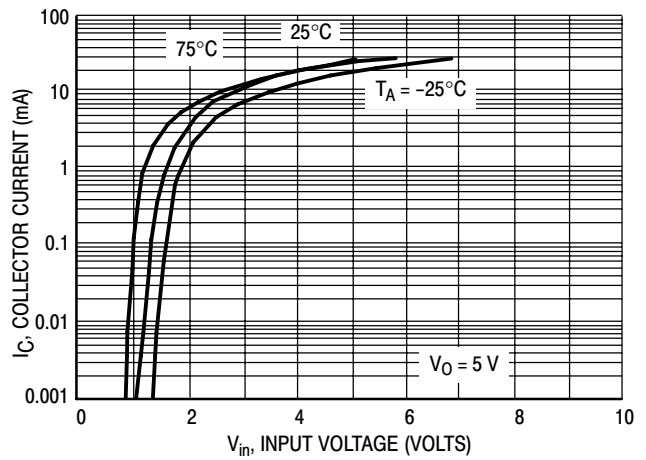

Figure 15. Output Current versus Input Voltage

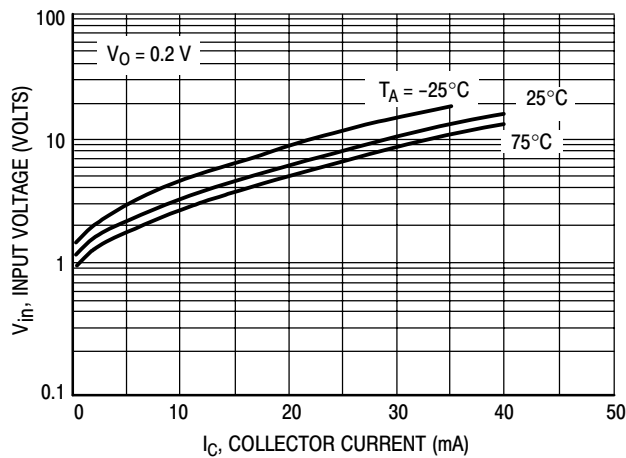

Figure 16. Input Voltage versus Output Current

# DTC114EM3T5G Series

## TYPICAL ELECTRICAL CHARACTERISTICS – DTC114YM3T5G

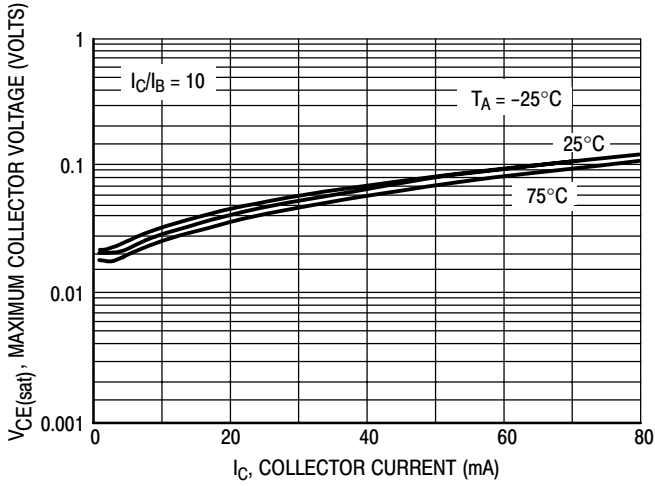

Figure 17.  $V_{CE(sat)}$  versus  $I_C$

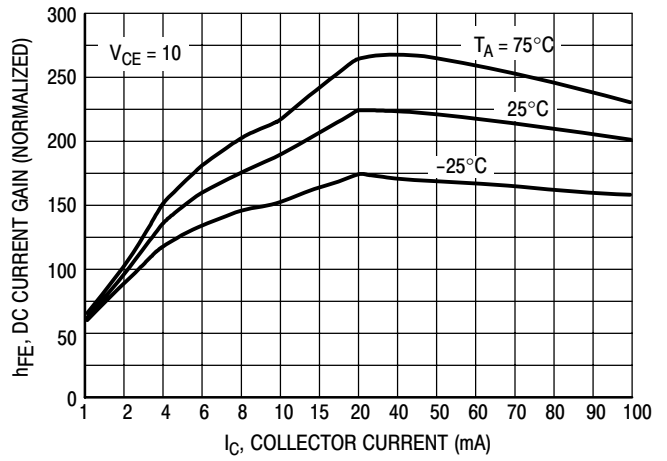

Figure 18. DC Current Gain

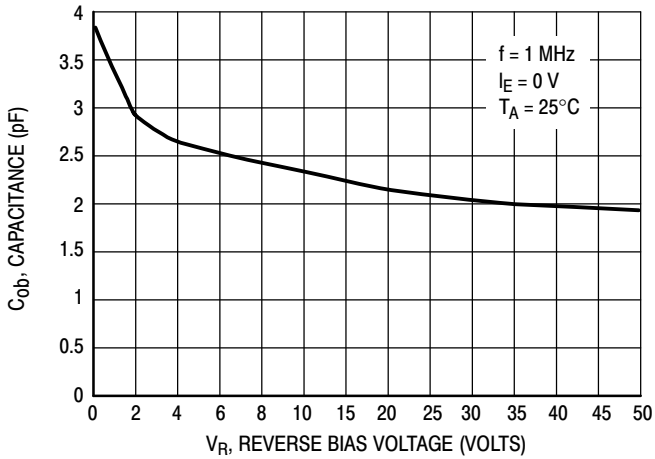

Figure 19. Output Capacitance

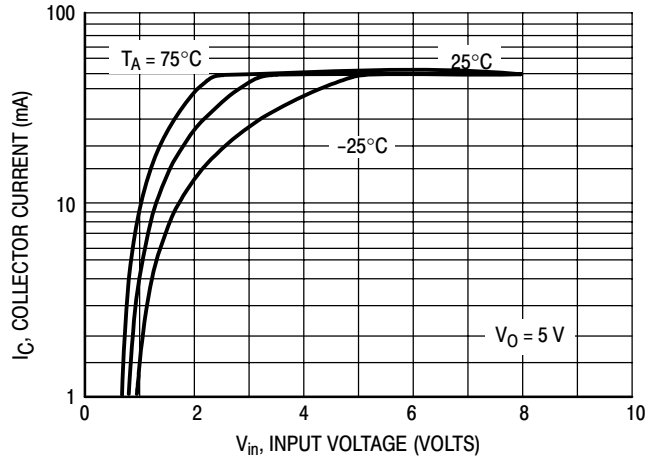

Figure 20. Output Current versus Input Voltage

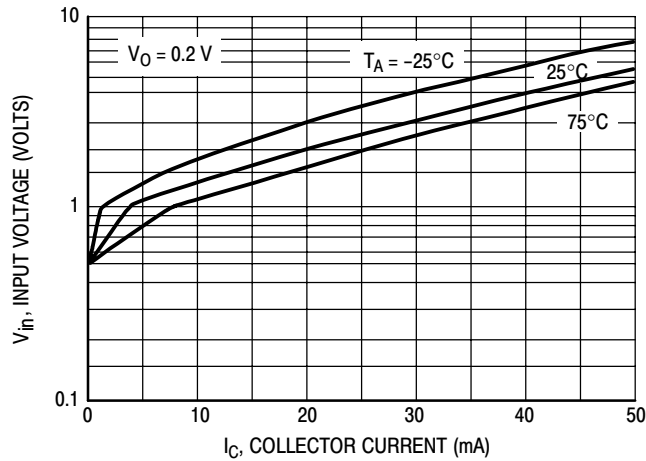

Figure 21. Input Voltage versus Output Current



# DTC114EM3T5G Series

## TYPICAL APPLICATIONS FOR NPN BRTs

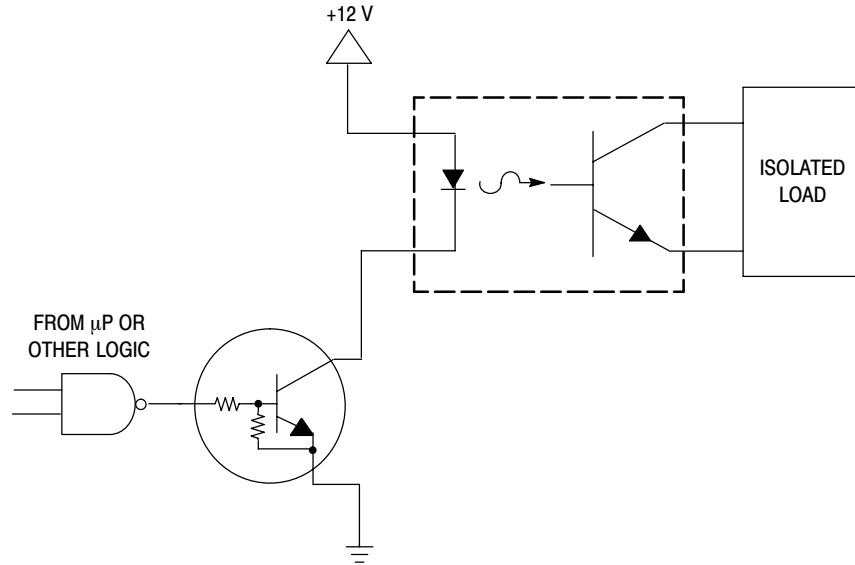

Figure 22. Level Shifter: Connects 12 or 24 Volt Circuits to Logic

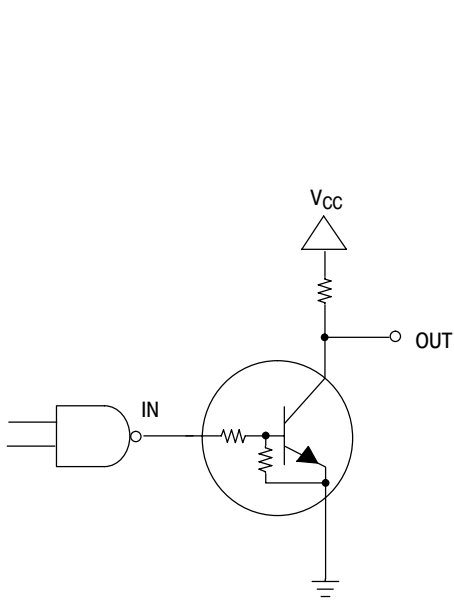

Figure 23. Open Collector Inverter:  
Inverts the Input Signal

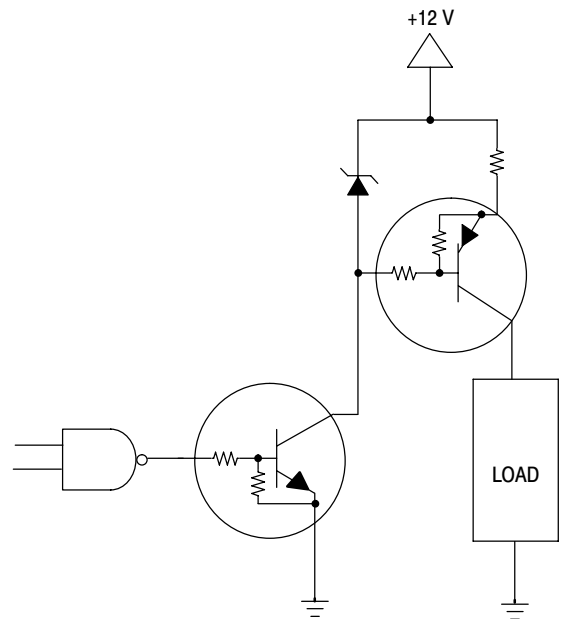
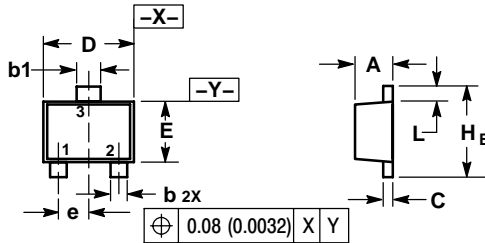

Figure 24. Inexpensive, Unregulated Current Source

# DTC114EM3T5G Series

## PACKAGE DIMENSIONS

SOT-723  
CASE 631AA-01  
ISSUE B



STYLE 1:  
PIN 1. BASE  
2. EMITTER  
3. COLLECTOR

NOTES:

1. DIMENSIONING AND TOLERANCING PER ANSI Y14.5M, 1982.
2. CONTROLLING DIMENSION: MILLIMETERS.
3. MAXIMUM LEAD THICKNESS INCLUDES LEAD FINISH. MINIMUM LEAD THICKNESS IS THE MINIMUM THICKNESS OF BASE MATERIAL.
4. DIMENSIONS D AND E DO NOT INCLUDE MOLD FLASH, PROTRUSIONS OR GATE BURRS.

DIM	MILLIMETERS			INCHES		
	MIN	NOM	MAX	MIN	NOM	MAX
A	0.45	0.50	0.55	0.018	0.020	0.022
b	0.15	0.21	0.27	0.0059	0.0083	0.0106
b1	0.25	0.31	0.37	0.010	0.012	0.015
C	0.07	0.12	0.17	0.0028	0.0047	0.0067
D	1.15	1.20	1.25	0.045	0.047	0.049
E	0.75	0.80	0.85	0.03	0.032	0.034
e	0.40 BSC			0.016 BSC		
H E	1.15	1.20	1.25	0.045	0.047	0.049
L	0.15	0.20	0.25	0.0059	0.0079	0.0098

### SOLDERING FOOTPRINT\*

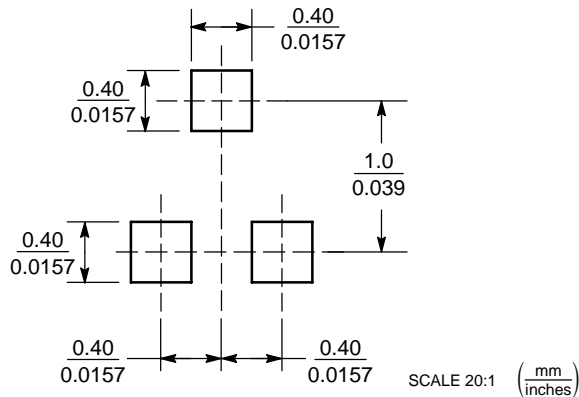

\*For additional information on our Pb-Free strategy and soldering details, please download the ON Semiconductor Soldering and Mounting Techniques Reference Manual, SOLDERRM/D.

ON Semiconductor and are registered trademarks of Semiconductor Components Industries, LLC (SCILLC). SCILLC reserves the right to make changes without further notice to any products herein. SCILLC makes no warranty, representation or guarantee regarding the suitability of its products for any particular purpose, nor does SCILLC assume any liability arising out of the application or use of any product or circuit, and specifically disclaims any and all liability, including without limitation special, consequential or incidental damages. "Typical" parameters which may be provided in SCILLC data sheets and/or specifications can and do vary in different applications and actual performance may vary over time. All operating parameters, including "Typicals" must be validated for each customer application by customer's technical experts. SCILLC does not convey any license under its patent rights nor the rights of others. SCILLC products are not designed, intended, or authorized for use as components in systems intended for surgical implant into the body, or other applications intended to support or sustain life, or for any other application in which the failure of the SCILLC product could create a situation where personal injury or death may occur. Should Buyer purchase or use SCILLC products for any such unintended or unauthorized application, Buyer shall indemnify and hold SCILLC and its officers, employees, subsidiaries, affiliates, and distributors harmless against all claims, costs, damages, and expenses, and reasonable attorney fees arising out of, directly or indirectly, any claim of personal injury or death associated with such unintended or unauthorized use, even if such claim alleges that SCILLC was negligent regarding the design or manufacture of the part. SCILLC is an Equal Opportunity/Affirmative Action Employer. This literature is subject to all applicable copyright laws and is not for resale in any manner.

### PUBLICATION ORDERING INFORMATION

**LITERATURE FULFILLMENT:**  
Literature Distribution Center for ON Semiconductor  
P.O. Box 61312, Phoenix, Arizona 85082-1312 USA  
**Phone:** 480-829-7710 or 800-344-3860 Toll Free USA/Canada  
**Fax:** 480-829-7709 or 800-344-3867 Toll Free USA/Canada  
**Email:** orderlit@onsemi.com

**N. American Technical Support:** 800-282-9855 Toll Free  
USA/Canada

**Japan:** ON Semiconductor, Japan Customer Focus Center  
2-9-1 Kamimeguro, Meguro-ku, Tokyo, Japan 153-0051  
**Phone:** 81-3-5773-3850

**ON Semiconductor Website:** <http://onsemi.com>

**Order Literature:** <http://www.onsemi.com/litorder>

For additional information, please contact your local Sales Representative.