

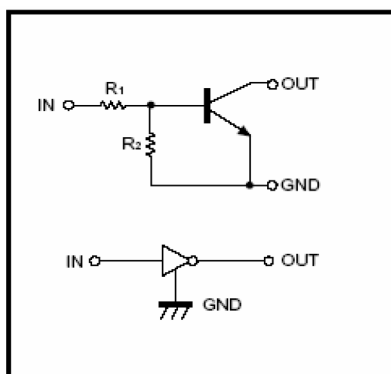

RoHS Compliant Product  
A suffix of "-C" specifies halogen & lead-free

## FEATURES

- Built-in bias resistors enable the configuration of an inverter circuit without connecting external input resistors (see equivalent circuit).
- The bias resistors consist of thin-film resistors with complete isolation to allow positive biasing of the input. They also have the advantage of almost completely eliminating parasitic effects.
- Only the on/off conditions need to be set for operation, making device design easy.

## EQUIVALENT CIRCUIT

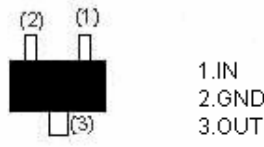

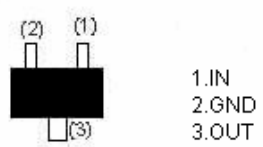
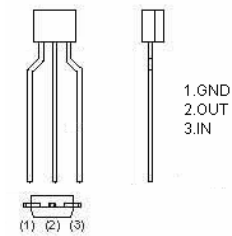
<p><b>DTC143ZE (SOT-523)</b></p>  <p>1.IN 2.GND 3.OUT</p> <p>Abbreviated symbol : E23</p>	<p><b>DTC143ZUA (SOT-323)</b></p>  <p>1.IN 2.GND 3.OUT</p> <p>Abbreviated symbol : E23</p>
<p><b>DTC143ZM (SOT-723)</b></p>  <p>1.IN 2.GND 3.OUT</p> <p>Abbreviated symbol : E23</p>	<p><b>DTC143ZCA (SOT-23)</b></p>  <p>1.IN 2.GND 3.OUT</p> <p>Abbreviated symbol : E23</p>
<p><b>DTA143ZSA (TO-92S)</b></p>  <p>1.GND 2.OUT 3.IN</p>	

## ABSOLUTE MAXIMUM RATINGS ( $T_A=25^\circ\text{C}$ unless otherwise noted)

Parameter	Symbol	Limits (DTC143Z□)					Unit
		M	E	UA	CA	SA	
Collector-Base Voltage	$V_{CC}$	50					V
Input voltage	$V_{IN}$	-5~30					V
Output current	$I_o$	100					mA
	$I_{C(MAX)}$	100					
Power dissipation	$P_D$	100	150	200		300	mW
Junction & Storage temperature	$T_J, T_{STG}$	150, -55~150					$^\circ\text{C}$

**ELECTRICAL CHARACTERISTICS** ( $T_A=25^\circ\text{C}$  unless otherwise noted)

Parameter	Symbol	Min.	Typ.	Max.	Unit	Test Conditions
Input voltage	$V_{I(off)}$	0.5	-	-	V	$V_{CC}=5\text{V}$ , $I_O=100\mu\text{A}$
	$V_{I(on)}$	-	-	1.3		$V_O=0.3\text{V}$ , $I_O=5\text{mA}$
Output voltage	$V_{O(on)}$	-	0.1	0.3	V	$I_O/I_I=5\text{mA}/0.25\text{mA}$
Input current	$I_I$	-	-	1.8	mA	$V_I=5\text{V}$
Output current	$I_{O(off)}$	-	-	0.5	$\mu\text{A}$	$V_{CC}=50\text{V}$ , $V_I=0$
DC current gain	$G_I$	80	-	-		$V_O=5\text{V}$ , $I_O=10\text{mA}$
Input resistance	$R_1$	3.29	4.7	6.11	K $\Omega$	
Resistance ratio	$R_2/R_1$	8	10	12		
Transition frequency	$f_T$	-	250	-	MHz	$V_{CE}=10\text{V}$ , $I_E=-5\text{mA}$ , $f=100\text{MHz}$

**CHARACTERISTIC CURVES**

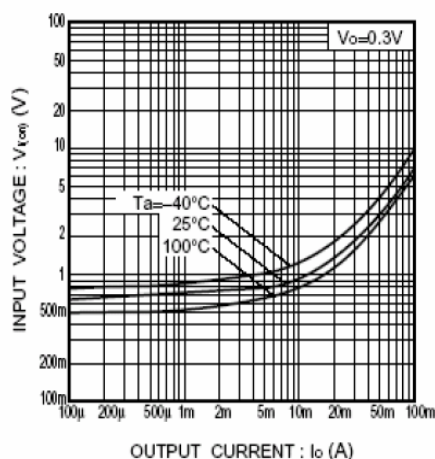

Fig.1 Input voltage vs. output current (ON characteristics)

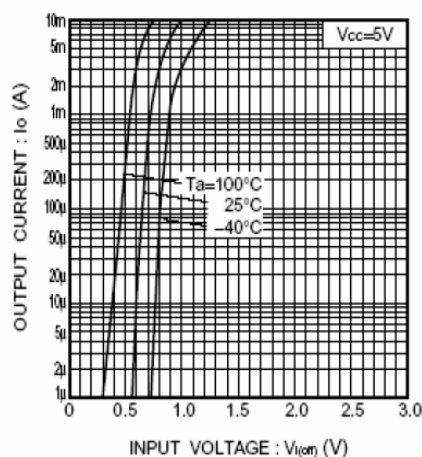

Fig.2 Output current vs. input voltage (OFF characteristics)

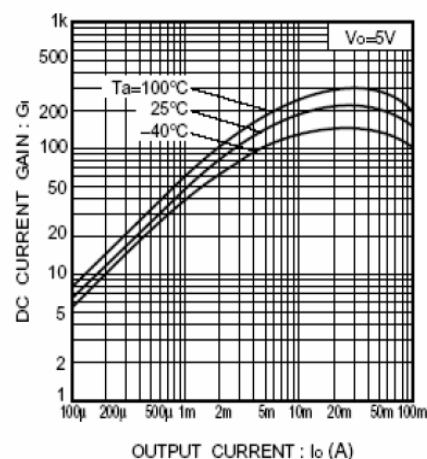

Fig.3 DC current gain vs. output current

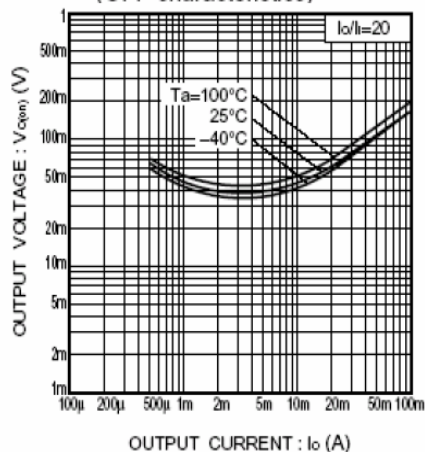

Fig.4 Output voltage vs. output current