

Triac / Standard Gate

Features

Repetitive Peak Off-State Voltage : 600V
 R.M.S On-State Current ($I_{T(RMS)} = 12 \text{ A}$)
 High Commutation dv/dt
 Isolation Voltage ($V_{ISO} = 2500\text{V AC}$)

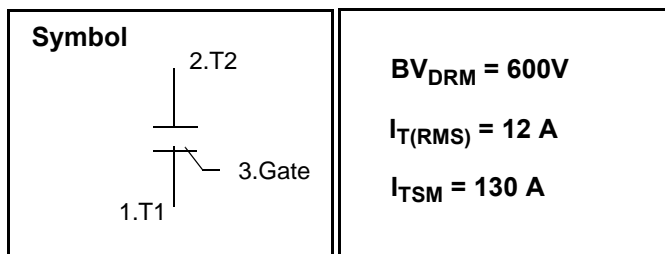

General Description

This device is fully isolated package suitable for AC switching application, phase control application such as fan speed and temperature modulation control, industrial and domestic light control and static switching relay.

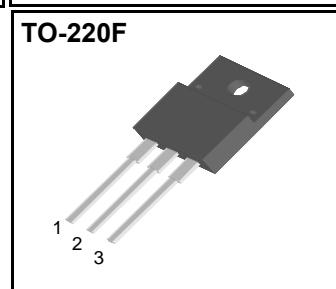

Absolute Maximum Ratings ($T_J = 25^\circ\text{C}$ unless otherwise specified)

Symbol	Parameter	Condition	Ratings	Units
V_{DRM}	Repetitive Peak Off-State Voltage	Sine wave, 50 to 60 Hz, Gate Open	600	V
$I_{T(RMS)}$	R.M.S On-State Current	$T_C = 79^\circ\text{C}$	12	A
I_{TSM}	Surge On-State Current	One Cycle, 50Hz/60Hz, Peak, Non-Repetitive	119/130	A
I^2t	I^2t	$t = 10\text{ms}$	71	A^2s
P_{GM}	Peak Gate Power Dissipation	$T_C = 79^\circ\text{C}$, Pulse width 1.0us	5.0	W
$P_{G(AV)}$	Average Gate Power Dissipation	Over any 20ms period	0.5	W
I_{GM}	Peak Gate Current	$t_p = 20\mu\text{s}$, $T_J = 125^\circ\text{C}$	2.0	A
V_{GM}	Peak Gate Voltage	$t_p = 20\mu\text{s}$, $T_J = 125^\circ\text{C}$	10	V
V_{ISO}	Isolation Breakdown Voltage(R.M.S.)	A.C. 1 minute	2500	V
T_J	Operating Junction Temperature		- 40 ~ 125	$^\circ\text{C}$
T_{STG}	Storage Temperature		- 40 ~ 150	$^\circ\text{C}$
	Mass		2.0	g

DTF12A60

Electrical Characteristics

Symbol	Items	Conditions	Ratings			Unit
			Min.	Typ.	Max.	
I_{DRM}	Repetitive Peak Off-State Current	$V_D = V_{DRM}$, Single Phase, Half Wave $T_J = 125\text{ }^\circ\text{C}$			2.0	mA
V_{TM}	Peak On-State Voltage	$I_T = 20\text{ A}$, Inst. Measurement			1.4	V
I_{GT1}^+	Gate Trigger Current	$V_D = 6\text{ V}$, $R_L = 10$			25	mA
I_{GT1}^-					25	
I_{GT3}^-					25	
V_{GT1}^+	Gate Trigger Voltage	$V_D = 6\text{ V}$, $R_L = 10$			1.5	V
V_{GT1}^-					1.5	
V_{GT3}					1.5	
V_{GD}	Non-Trigger Gate Voltage	$T_J = 125\text{ }^\circ\text{C}$, $V_D = 1/2 V_{DRM}$	0.2			V
$(dv/dt)_c$	Critical Rate of Rise Off-State Voltage at Commutation	$T_J = 125\text{ }^\circ\text{C}$, $[di/dt]_c = -6.0\text{ A/ms}$, $V_D = 2/3 V_{DRM}$	10			V/ μs
I_H	Holding Current			20		mA
$R_{th(j-c)}$	Thermal Impedance	Junction to case			3.3	$^\circ\text{C/W}$

DTF12A60

Fig 1. Gate Characteristics

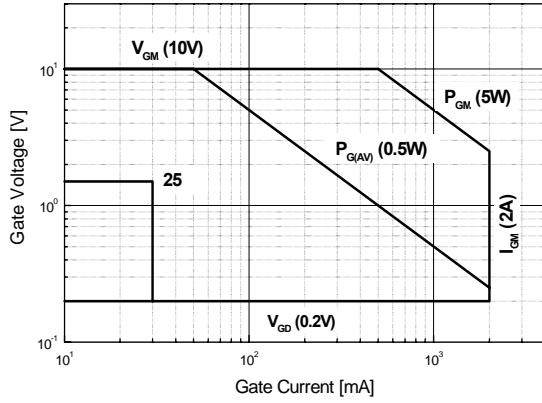

Fig 2. On-State Voltage

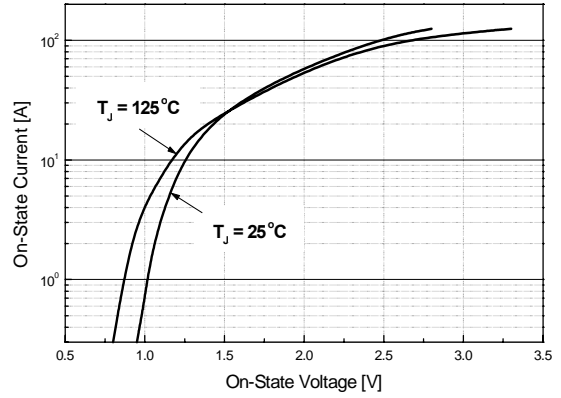

Fig 3. On State Current vs. Maximum Power Dissipation

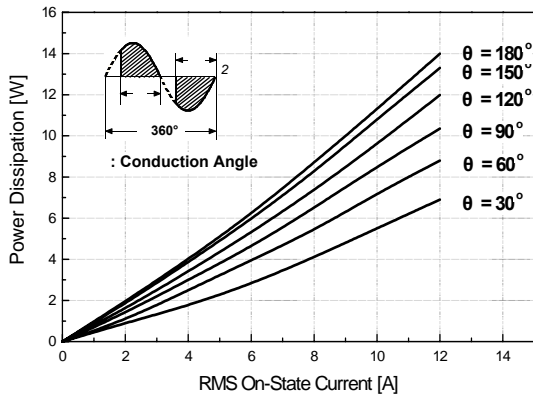

Fig 4. On State Current vs. Allowable Case Temperature

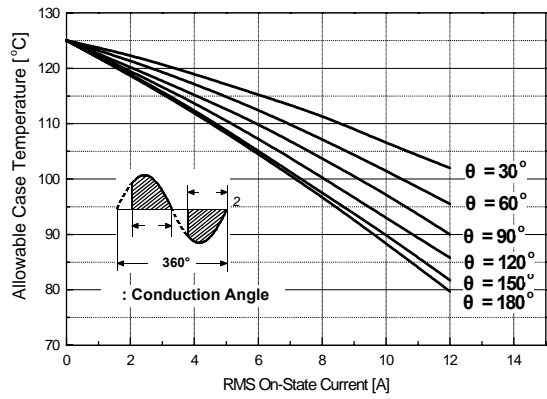

Fig 5. Surge On-State Current Rating (Non-Repetitive)

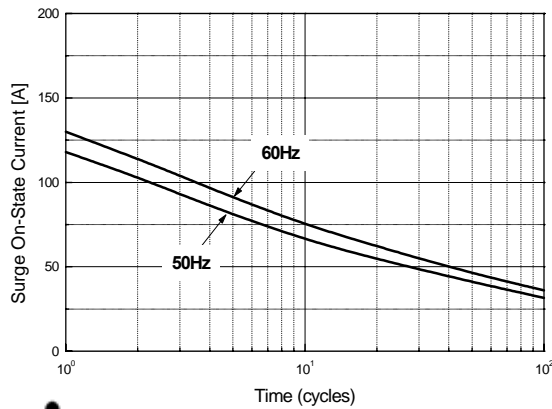
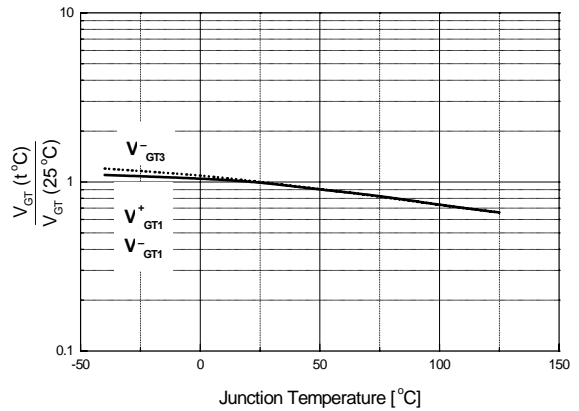

Fig 6. Gate Trigger Voltage vs. Junction Temperature



DTF12A60

Fig 7. Gate Trigger Current vs. Junction Temperature

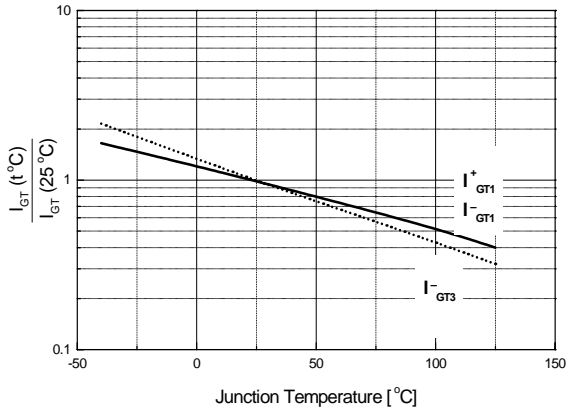

Fig 8. Transient Thermal Impedance

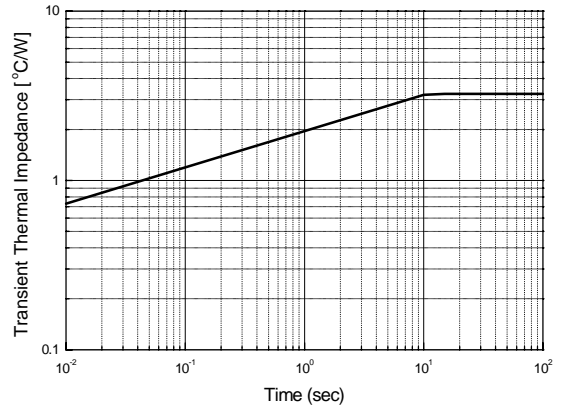
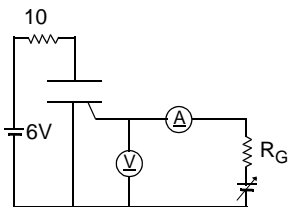
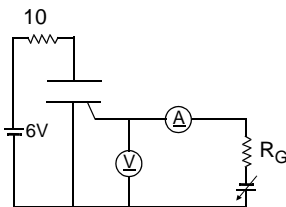

Fig 9. Gate Trigger Characteristics Test Circuit



Test Procedure



Test Procedure

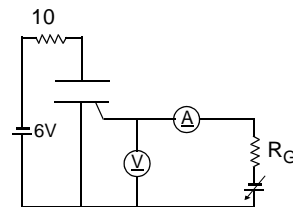

Test Procedure

DTF12A60

TO-220F Package Dimension

Dim.	mm			Inch		
	Min.	Typ.	Max.	Min.	Typ.	Max.
A	10.4		10.6	0.409		0.417
B	6.18		6.44	0.243		0.254
C	9.55		9.81	0.376		0.386
D	13.47		13.73	0.530		0.540
E	6.05		6.15	0.238		0.242
F	1.26		1.36	0.050		0.054
G	3.17		3.43	0.125		0.135
H	1.87		2.13	0.074		0.084
I	2.57		2.83	0.101		0.111
J		2.54			0.100	
K		5.08			0.200	
L	2.51		2.62	0.099		0.103
M	1.25		1.55	0.049		0.061
N	0.45		0.63	0.018		0.025
O	0.6		1.0	0.024		0.039
		3.7			0.146	
1		3.2			0.126	
2		1.5			0.059	

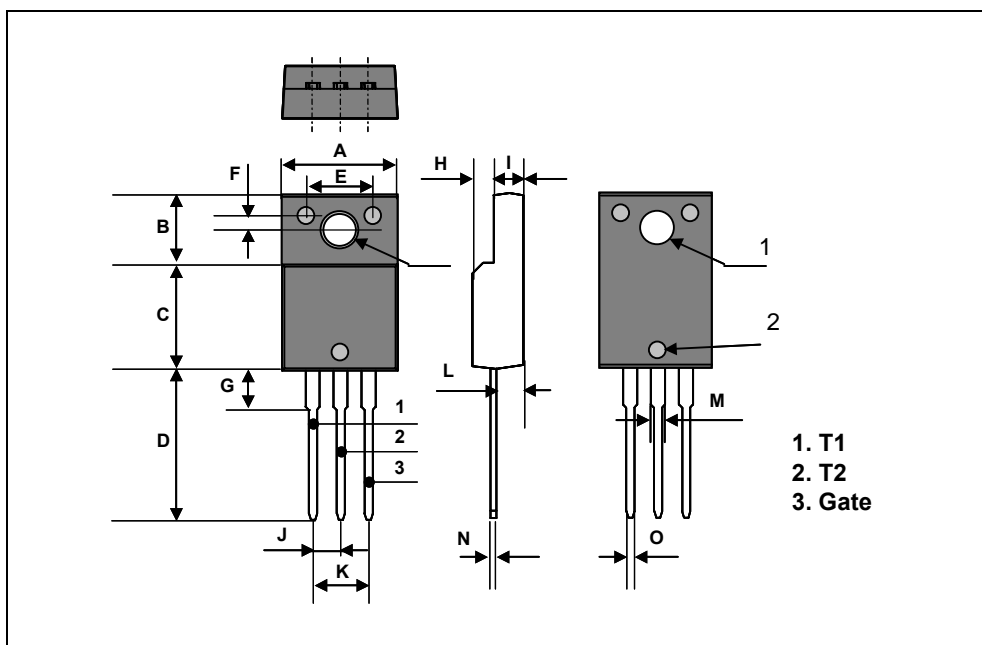

DTF12A60

TO-220F Package Dimension, Forming

Dim.	mm			Inch		
	Min.	Typ.	Max.	Min.	Typ.	Max.
A	10.4		10.6	0.409		0.417
B	6.18		6.44	0.243		0.254
C	9.55		9.81	0.376		0.386
D	8.4		8.66	0.331		0.341
E	6.05		6.15	0.238		0.242
F	1.26		1.36	0.050		0.054
G	3.17		3.43	0.125		0.135
H	1.87		2.13	0.074		0.084
I	2.57		2.83	0.101		0.111
J		2.54			0.100	
K		5.08			0.200	
L	2.51		2.62	0.099		0.103
M	1.25		1.55	0.049		0.061
N	0.45		0.63	0.018		0.025
O	0.6		1.0	0.024		0.039
P		5.0			0.197	
		3.7			0.146	
1		3.2			0.126	
2		1.5			0.059	

