

General Description

Din-Tek Field Stop Trench IGBTs offer low switching losses, high energy efficiency and short circuit ruggedness.

It is designed for applications such as motor control, uninterrupted power supplies(UPS), general inverters.

FEATURES

- High speed switching
- High system efficiency
- Short Circuit Withstand Times 10us
- Extremely enhanced avalanche capability

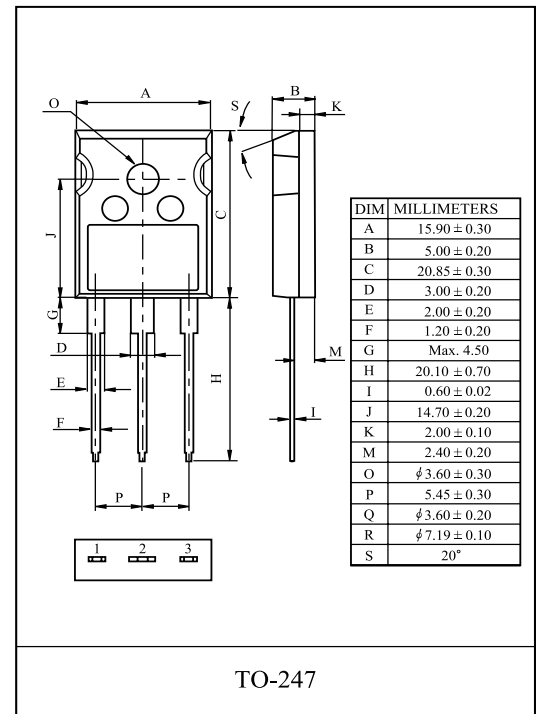

MAXIMUM RATING (Ta=25)

CHARACTERISTIC	SYMBOL	RATING	UNIT
Collector-Emitter Voltage	V _{CES}	1200	V
Gate-Emitter Voltage	V _{GES}	± 20	V
Collector Current	I _C	@Tc=25	80
		@Tc=100	40
Pulsed Collector Current	I _{CM} *	120	A
Diode Continuous Forward Current	@Tc=100	I _F	40
Diode Maximum Forward Current	I _{FM}	160	A
Maximum Power Dissipation	P _D	@Tc=25	357
		@Tc=100	140
Maximum Junction Temperature	T _j	150	
Storage Temperature Range	T _{stg}	-55 to + 150	

*Repetitive rating : Pulse width limited by max. junction temperature

THERMAL CHARACTERISTIC

CHARACTERISTIC	SYMBOL	MAX.	UNIT
Thermal Resistance, Junction to Case (IGBT)	R _{thJC}	0.35	/W
Thermal Resistance, Junction to Case (DIODE)	R _{thJC}	1.1	/W
Thermal Resistance, Junction to Ambient	R _{thJA}	40	/W

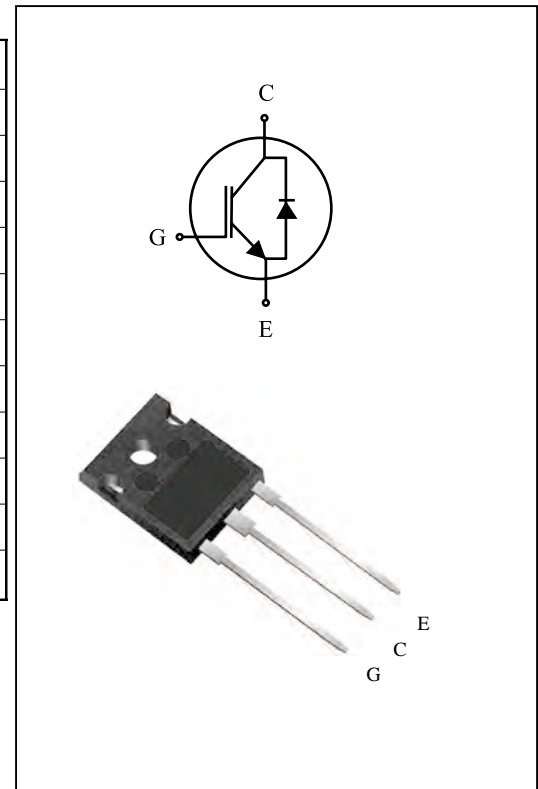

ELECTRICAL CHARACTERISTICS (Ta=25)

CHARACTERISTIC	SYMBOL	TEST CONDITION	MIN.	TYP.	MAX.	UNIT	
Static							
Collector-Emitter Breakdown Voltage	BV_{CES}	$V_{GE}=0V, I_C=1mA$	1200	-	-	V	
Collector Cut-off Current	I_{CES}	$V_{GE}=0V, V_{CE}=1200V$	-	-	1.0	mA	
Gate Leakage Current	I_{GES}	$V_{CE}=0V, V_{GE}=\pm 20V$	-	-	± 100	nA	
Gate Threshold Voltage	$V_{GE(th)}$	$V_{GE}=V_{CE}, I_C=40mA$	4.5	6.0	7.5	V	
Collector-Emitter Saturation Voltage	$V_{CE(sat)}$	$V_{GE}=15V, I_C=40A$	-	1.9	2.25	V	
		$V_{GE}=15V, I_C=40A, T_C = 125$	-	2.2	-	V	
		$V_{GE}=15V, I_C=80A$	-	2.5	-	V	
Dynamic							
Total Gate Charge	Q_g	$V_{CC}=600V, V_{GE}=15V, I_C= 40A$	-	230	350	nC	
Gate-Emitter Charge	Q_{ge}		-	30	-	nC	
Gate-Collector Charge	Q_{gc}		-	110	-	nC	
Turn-On Delay Time	$t_{d(on)}$	$V_{CC}=600V, I_C=40A, V_{GE}=15V, R_G=10$ Inductive Load, $T_C = 25$	-	60	-	ns	
Rise Time	t_r		-	45	-	ns	
Turn-Off Delay Time	$t_{d(off)}$		-	310	-	ns	
Fall Time	t_f		-	70	-	ns	
Turn-On Switching Loss	E_{on}		-	3.5	5.2	mJ	
Turn-Off Switching Loss	E_{off}		-	1.9	2.8	mJ	
Total Switching Loss	E_{ts}		-	5.4	8.0	mJ	
Turn-On Delay Time	$t_{d(on)}$		$V_{CC}=600V, I_C=40A, V_{GE}=15V, R_G=10$ Inductive Load, $T_C = 125$	-	60	-	ns
Rise Time	t_r			-	50	-	ns
Turn-Off Delay Time	$t_{d(off)}$			-	350	-	ns
Fall Time	t_f	-		175	-	ns	
Turn-On Switching Loss	E_{on}	-		4.3	6.4	mJ	
Turn-Off Switching Loss	E_{off}	-		3.0	4.5	mJ	
Total Switching Loss	E_{ts}	-		7.3	10.9	mJ	
Input Capacitance	C_{ies}	$V_{CE}=30V, V_{GE}=0V, f=1MHz$	-	4800	-	pF	
Output Capacitance	C_{oes}		-	195	-	pF	
Reverse Transfer Capacitance	C_{res}		-	135	-	pF	
Short Circuit Withstand Time	t_{sc}		$V_{CC}=600V, V_{GE}=15V, T_C=100$	10	-	-	μs

ELECTRICAL CHARACTERISTIC OF DIODE

CHARACTERISTIC	SYMBOL	TEST CONDITION		MIN.	TYP.	MAX.	UNIT
Diode Forward Voltage	V_F	$I_F = 40A$	$T_C = 25$	-	2.2	2.6	V
			$T_C = 125$	-	1.9	-	
Diode Reverse Recovery Time	t_{rr}	$I_F = 40A$	$T_C = 25$	-	360	520	ns
			$T_C = 125$	-	460	-	
Diode Peak Reverse Recovery Current	I_{rr}	$I_F = 40A$ $di/dt = 200A/\mu s$	$T_C = 25$	-	16	21	A
			$T_C = 125$	-	19	-	
Diode Reverse Recovery Charge	Q_{rr}	$I_F = 40A$ $di/dt = 200A/\mu s$	$T_C = 25$	-	2800	4200	nC
			$T_C = 125$	-	5200	-	

Fig 1. Saturation Voltage Characteristics

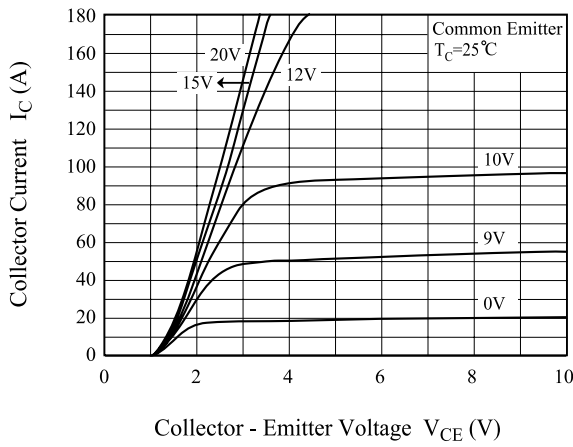

Fig 2. Saturation Voltage Characteristics

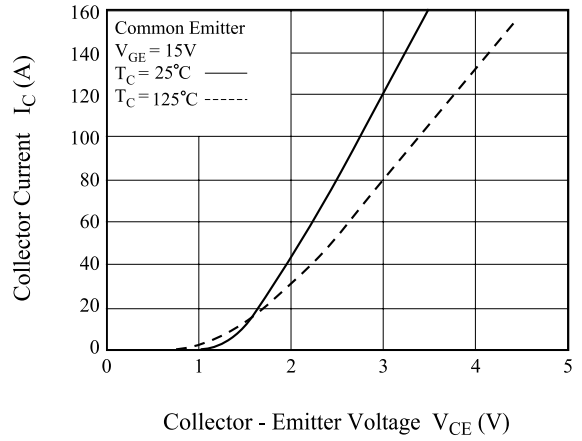

Fig 3. Saturation Voltage vs. Case Temperature

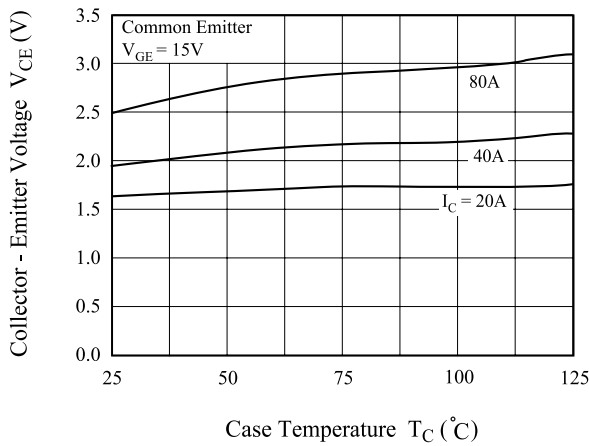

Fig 4. Saturation Voltage vs. V_{GE}

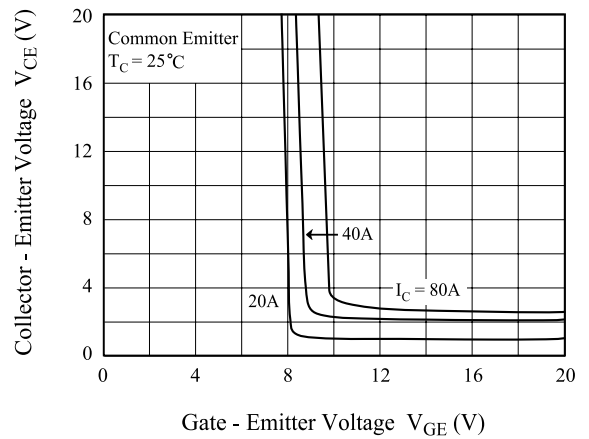

Fig 5. Saturation Voltage vs. V_{GE}

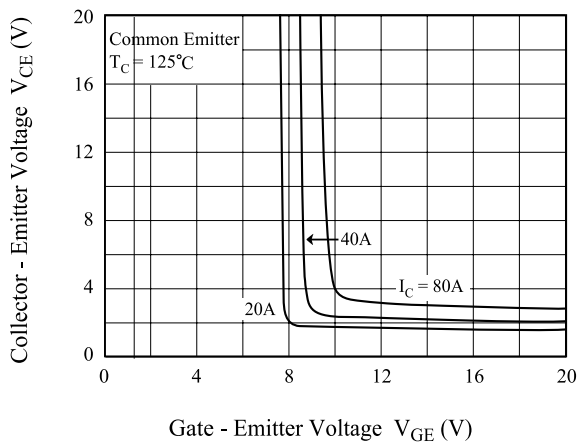

Fig 6. Capacitance Characteristics

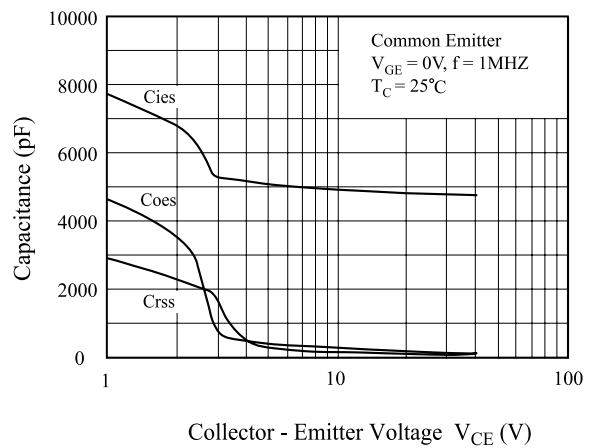

Fig 7. Turn-On Characteristics vs. Gate Resistance

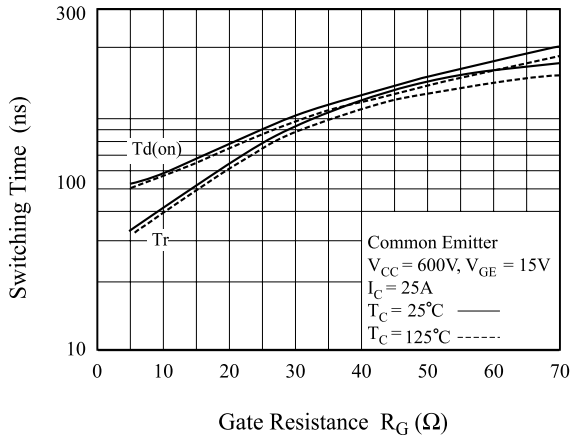

Fig 8. Turn-Off Characteristics vs. Gate Resistance

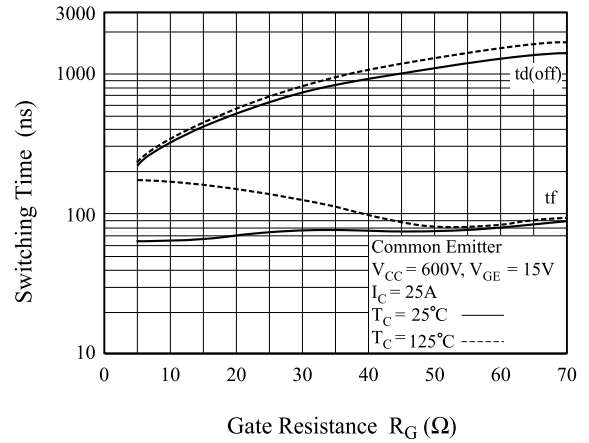

Fig 9. Switching Loss vs. Gate Resistance

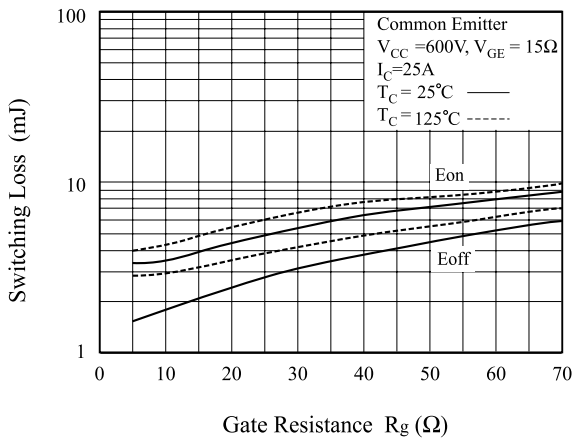

Fig 10. Turn-On Characteristics vs Collector Current

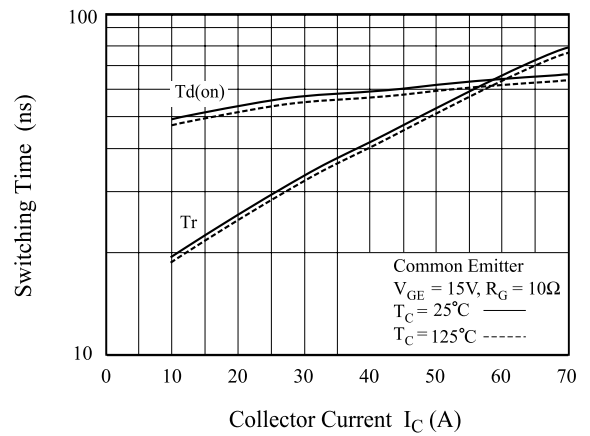

Fig 11. Turn-Off Characteristics vs Collector Current

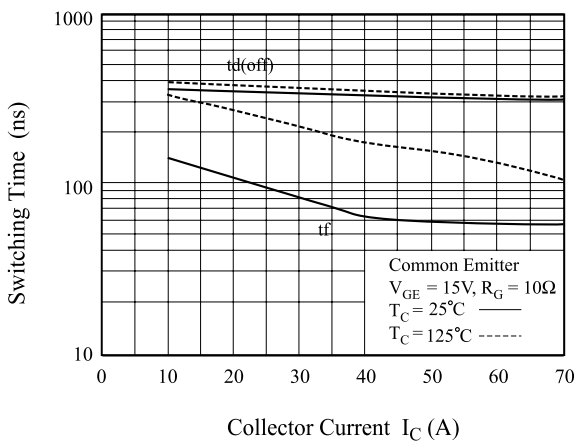

Fig 12. Switching Loss vs. Collector Current

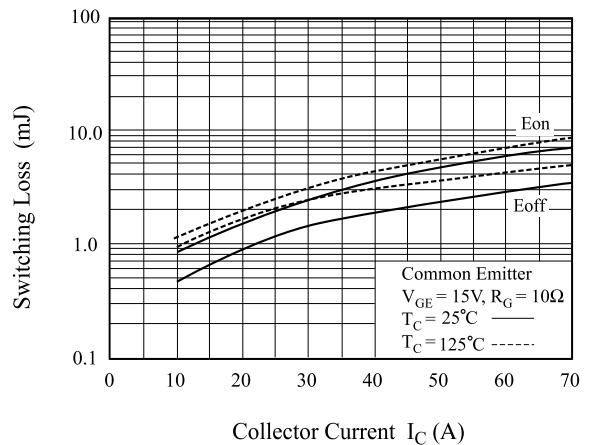

Fig 13. Gate Charge Characteristics

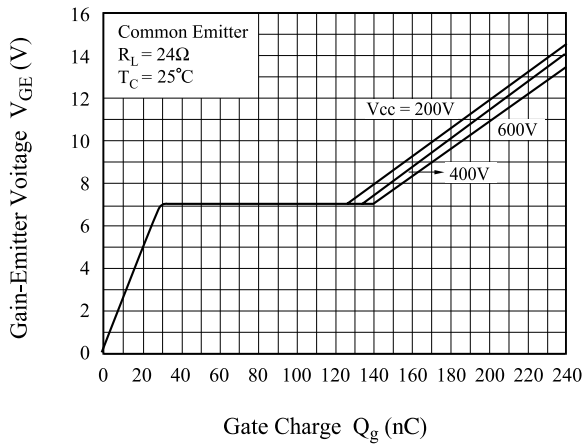

Fig 14. SOA Characteristics

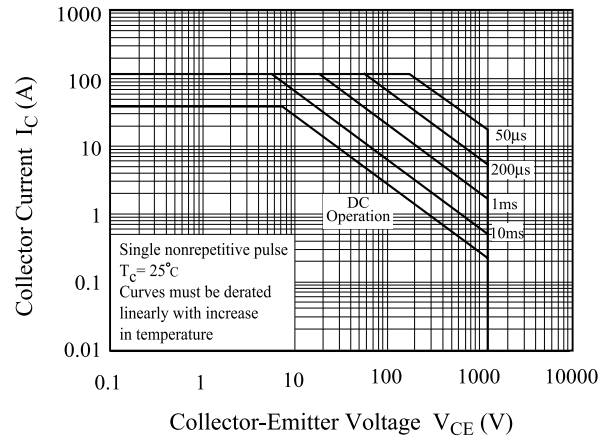

Fig 15. Turn-Off SOA

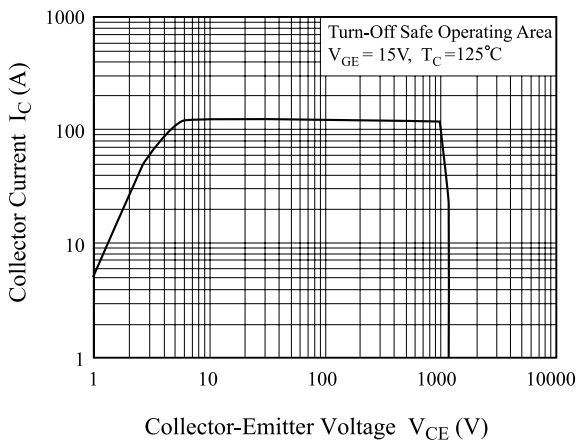

Fig 16. Transient Thermal Impedance of IGBT

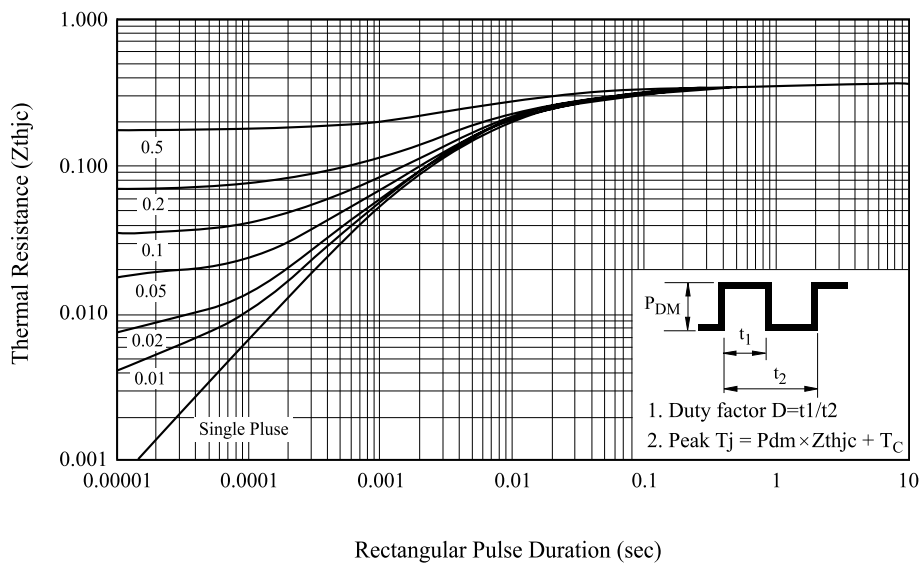

Fig 17. Forward Characteristics

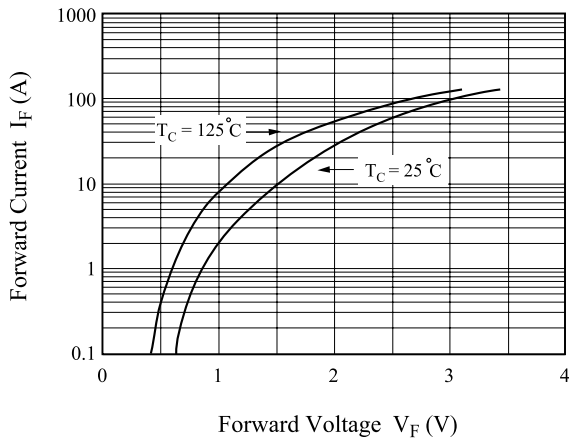

Fig 18. Reverse Recovery Current

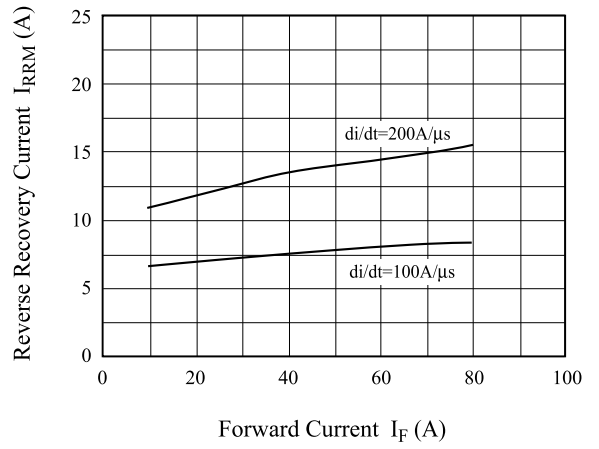

Fig 19. Reverse Recovery Time

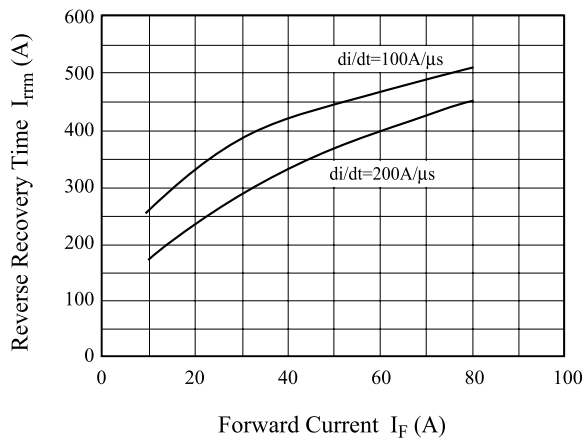

Fig 21. Switching Test Circuit

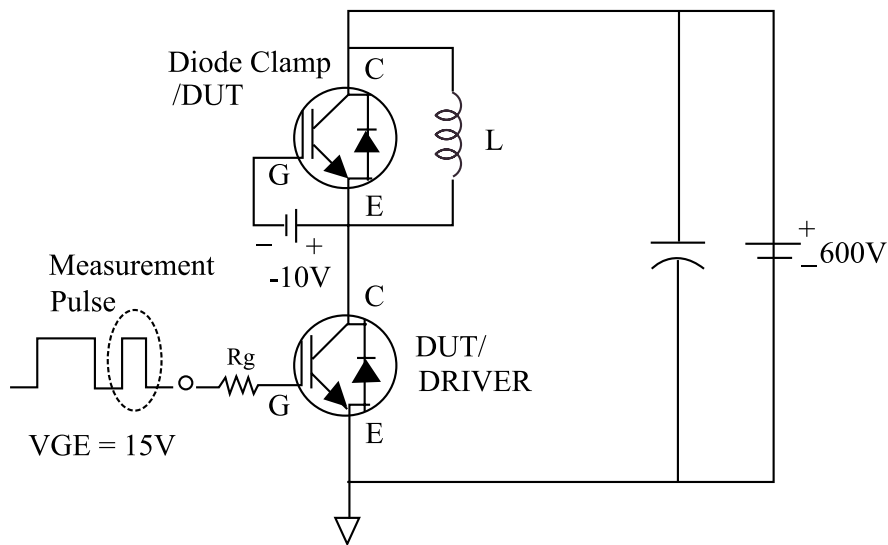

Fig 22. Definition Switching Time & Loss

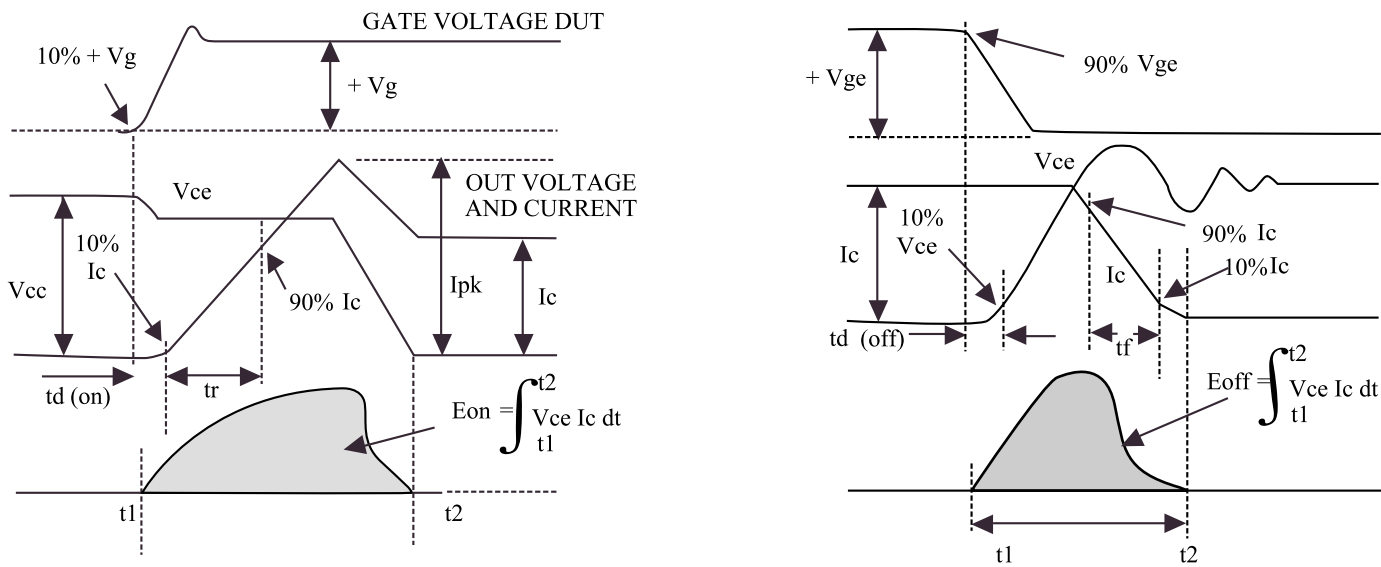
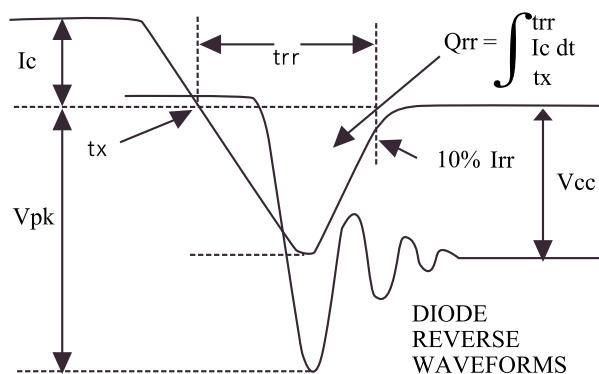
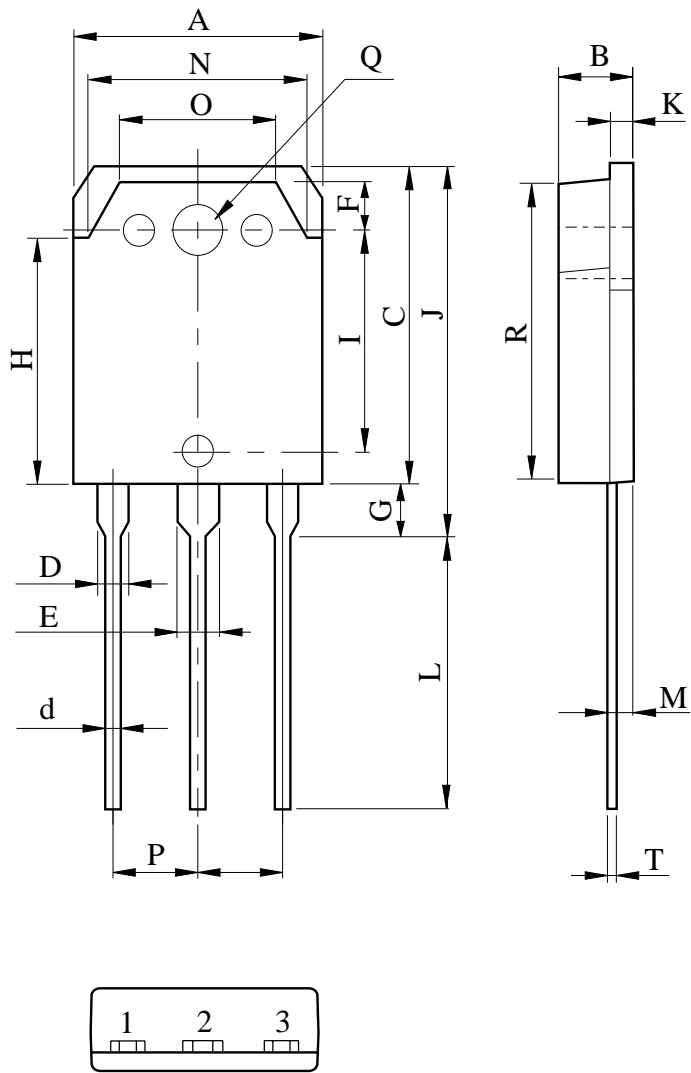

Fig 23. Definition Diode Switching Time



TO-3P (High Voltage)



DIM	MILLIMETERS
A	15.60±0.20
B	4.80±0.20
C	19.90±0.20
D	2.00±0.20
d	1.00±0.20
E	3.00±0.20
F	3.80±0.20
G	3.50±0.20
H	13.90±0.20
I	12.76±0.20
J	23.40±0.20
K	1.5+0.15-0.05
L	16.50±0.30
M	1.40±0.20
O	9.60±0.20
P	5.45±0.30
Q	φ 3.20±0.10
R	18.70±0.20
T	0.60+0.15-0.05

Disclaimer

ALL PRODUCT, PRODUCT SPECIFICATIONS AND DATA ARE SUBJECT TO CHANGE WITHOUT NOTICE TO IMPROVE RELIABILITY, FUNCTION OR DESIGN OR OTHERWISE.

Din-Tek Intertechnology, Inc., its affiliates, agents, and employees, and all persons acting on its or their behalf (collectively, "Din-Tek"), disclaim any and all liability for any errors, inaccuracies or incompleteness contained in any datasheet or in any other disclosure relating to any product.

Din-Tek makes no warranty, representation or guarantee regarding the suitability of the products for any particular purpose or the continuing production of any product. To the maximum extent permitted by applicable law, Din-Tek disclaims (i) any and all liability arising out of the application or use of any product, (ii) any and all liability, including without limitation special, consequential or incidental damages, and (iii) any and all implied warranties, including warranties of fitness for particular purpose, non-infringement and merchantability.

Statements regarding the suitability of products for certain types of applications are based on Din-Tek's knowledge of typical requirements that are often placed on Din-Tek products in generic applications. Such statements are not binding statements about the suitability of products for a particular application. It is the customer's responsibility to validate that a particular product with the properties described in the product specification is suitable for use in a particular application. Parameters provided in datasheets and/or specifications may vary in different applications and performance may vary over time. All operating parameters, including typical parameters, must be validated for each customer application by the customer's technical experts. Product specifications do not expand or otherwise modify Din-Tek's terms and conditions of purchase, including but not limited to the warranty expressed therein.

Except as expressly indicated in writing, Din-Tek products are not designed for use in medical, life-saving, or life-sustaining applications or for any other application in which the failure of the Din-Tek product could result in personal injury or death. Customers using or selling Din-Tek products not expressly indicated for use in such applications do so at their own risk. Please contact authorized Din-Tek personnel to obtain written terms and conditions regarding products designed for such applications.

No license, express or implied, by estoppel or otherwise, to any intellectual property rights is granted by this document or by any conduct of Din-Tek. Product names and markings noted herein may be trademarks of their respective owners.

Material Category Policy

Din-Tek Intertechnology, Inc. hereby certifies that all its products that are identified as RoHS-Compliant fulfill the definitions and restrictions defined under Directive 2011/65/EU of The European Parliament and of the Council of June 8, 2011 on the restriction of the use of certain hazardous substances in electrical and electronic equipment (EEE) - recast, unless otherwise specified as non-compliant.

Please note that some Din-Tek documentation may still make reference to RoHS Directive 2002/95/EC. We confirm that all the products identified as being compliant to Directive 2002/95/EC conform to Directive 2011/65/EU.

Din-Tek Intertechnology, Inc. hereby certifies that all its products that are identified as Halogen-Free follow Halogen-Free requirements as per JEDEC JS709A standards. Please note that some Din-Tek documentation may still make reference to the IEC 61249-2-21 definition. We confirm that all the products identified as being compliant to IEC 61249-2-21 conform to JEDEC JS709A standards.