

鋁電解電容器

Aluminum Electrolytic Capacitors



永茂電子有限公司
MAXCAP Electronics co., Ltd.



永茂電子有限公司

MAXCAP Electronics Co., Ltd.



永茂電子(馬來西亞)有限公司 MAXCAP Electronics (M) Sdn. Bhd.



永茂電子(昆山)有限公司 MAXCAP Electronics (KunShan) Co., Ltd.

簡介 Background

永茂電子有限公司於 1987 年 10 月 6 日在馬來西亞成立，是北馬地區第一家制造徑向引線，軸向引線，焊針引線的電解電容器工廠。可生產容量範圍 0.1 μF ~680,000 μF ，電壓範圍 4V~450V，溫度範圍 -55 $^{\circ}\text{C}$ ~+125 $^{\circ}\text{C}$ 的用於電源供應器，電子線路，音響，電視機，汽車的各類產品。隨著國內外對產品需求的增加，公司於 2001 年在昆山（緊鄰上海）新建了一座工廠，已全面投入生產。

近二十年的電容器生產經驗，使我們的產品質量能夠保證支持銷售的增長。配合高品質主要來自日本的原料和全自動生產線，結合日本的制造技術和管理，確保我們的產品品質優良。在值得信賴的全體員工共同努力下，公司在 1998 年 11 月獲得了 ISO9002 質量體系認證，進一步提升了我們自己的質量水準。我們的哲學是優秀的品質，可信賴的服務，不斷改進的設計，永遠保持與客戶共同成長。

Established on the 6th of October 1987, Maxcap Electronics is the first manufacturer of axial, radial and snap-in type of aluminum electrolytic capacitors in the northern region of Malaysia. Our product ranges from 0.1 μF to 680,000 μF with a working voltage ranging from 4V to 450V and working temperature ranges from -55 $^{\circ}\text{C}$ to +125 $^{\circ}\text{C}$. We also produce bi-polar capacitors for audio crossover networks and TV monitor horizontal deflection. In anticipation of increase in domestic and overseas demand for our products, The company has built a new factory in Kunshan, Jiangsu Province, China. This factory has been fully operational by year 2001. For more than a decade now, assurance of our products' quality accounts for our sustained sales growth. Equipped with high grade imported raw materials coming from different dependable companies and backed by Japanese modern technologies in the manufacturing facilities ensure our excellent quality. With the help of our dedicated employees to whom the company credits success, obtained the ISO9002 accreditation on November 6, 1998, which meant that we had already elevated ourselves to international quality status. This quality certification has been up-graded to ISO-9001:2000 version in year 2002. Our company accepts custom-made requirements without neglecting the quality of the product. Our philosophy of excellent quality, dependable service, on-going innovation and designs keeps our customers with us year after year.



ISO 質量認證 ISO Quality Certificate

目 錄

Contents

產品系列表	-----	2
Series Table		
產品體系圖	-----	3
Series Chart		
鋁電解電容器使用注意事項	-----	4
Guidelines for Application of Aluminum Electrolytic Capacitors		
怎樣定購鋁電解電容器	-----	6
How to Order Aluminum Electrolytic Capacitors		
成形及切腳說明	-----	7
Lead Cut and Forming Specification		
編帶說明	-----	8
Taping Specification		

產品系列表

Series Table

系列 Series	特性 Feature	结构类型 Terminal Type	温度范围 Temperature Range (°C)	电压范围 Voltage Range (V)	容量范围 Capacitance Range (uF)	耐久性 Load Life (小时 Hours)	颜色 Color	页数 Page
微小型 Ultra - Miniature	SSS 5mm 高 5mm height	径向引线 Radial	- 40 ~ + 85	4 ~ 50	0.1 ~ 220	2000	黑色 Black	10
	SSE 7mm 高 7mm height	径向引线 Radial	- 40 ~ + 85	4 ~ 63	0.1 ~ 220	2000	黑色 Black	11
	SSK 宽温, 7mm 高 7mm height, 105°C	径向引线 Radial	- 55 ~ + 105	6.3 ~ 63	0.1 ~ 220	1000	深紫色 Dark purple	12
	SL 低漏电, 7mm 高 Low leakage current 7mm height	径向引线 Radial	- 40 ~ + 85	6.3 ~ 50	0.1 ~ 100	1000	灰色 Grey	13
小型 Miniature Type	MSR 标准品, 普通用途 Standard products, General purpose use	径向引线 Radial	- 40(25) ~ + 85	6.3 ~ 450	0.1 ~ 22,000	3000 ~ 5000	黑色 Black	14
	MKR 标准品, 普通用途, 宽温, 105°C Standard products, General purpose use	径向引线 Radial	- 40(25) ~ + 105	6.3 ~ 450	0.1 ~ 15,000	1000 ~ 3000	深紫色 Dark purple	16
	SR 缩体, 高电容值 High CV value	径向引线 Radial	- 40(25) ~ + 85	6.3 ~ 450	1.0 ~ 33,000	1000 ~ 3000	黑色 Black	18
	SK 缩体, 宽温, 高电容值 High CV value, 105°C	径向引线 Radial	- 40(25) ~ + 105	6.3 ~ 450	1.0 ~ 33,000	1000 ~ 2000	深紫色 Dark purple	20
	LL 低漏电 Low leakage current	径向引线 Radial	- 40 ~ + 85	6.3 ~ 100	0.1 ~ 10,000	3000 ~ 5000	灰色 Grey	22
	MBP 小型, 双极性 Miniaturized, Bi-polar	径向引线 Radial	- 40 ~ + 85	6.3 ~ 250	0.47 ~ 6,800	1000 ~ 3000	深蓝色 Dark blue	24
	MKP 小型, 双极性, 宽温 Miniaturized, Bi-polar, 105°C	径向引线 Radial	- 55 ~ + 105	6.3 ~ 250	0.47 ~ 6,800	1000	深蓝色 Dark blue	26
	SBP 双极性, 音响用 Bi-polar, Speaker cross over network	径向引线 Radial	- 40 ~ + 85	25 ~ 100	0.33 ~ 100	3000	蓝色 Blue	28
	UBP 双极性, 行扫描用 Bi-polar, Horizontal deflection	径向引线 Radial	- 20 ~ + 85	25 ~ 50	2.2 ~ 10	3000	浅蓝色 Light blue	29
	HT 125°C 高温用 For 125°C use	径向引线 Radial	- 40 ~ + 125	10 ~ 50	1.0 ~ 4,700	1000	深绿色 Dark green	30
	MLI 低阻抗, 宽温 Low impedance, 105°C	径向引线 Radial	- 55 ~ + 105	6.3 ~ 100	0.47 ~ 15,000	1000 ~ 3000	深褐色 Dark brown	31
	MLC 超低阻抗, 宽温 Extremely low impedance, 105°C	径向引线 Radial	- 55 ~ + 105	6.3 ~ 63	47 ~ 6,800	2000 ~ 3000	深褐色 Dark brown	36
	MST 小型, 普通用途 Miniaturized, General purpose use	轴向引线 Radial	- 40(25) ~ + 85	6.3 ~ 450	0.15 ~ 22,000	2000 ~ 4000	黑色 Black	38
	MBT 小型, 双极性 Miniaturized, Bi-polar	轴向引线 Radial	- 40 ~ + 85	6.3 ~ 100	0.47 ~ 6,800	2000 ~ 3000	深蓝色 Dark blue	40
SBT 双极性, 音响用 Bi-polar, Speaker cross over network	轴向引线 Radial	- 40 ~ + 85	25 ~ 100	0.33 ~ 68	2000 ~ 3000	蓝色 Blue	41	
大型 Large Can	LSR 普通用途 General purpose use	焊针 Snap-in	- 40 (25) ~ + 85	10 ~ 450	56 ~ 68,000	3000	黑色 Black	42
	LKR 普通用途, 宽温 General purpose use, 105°C	焊针 Snap-in	- 40(25) ~ + 105	10 ~ 450	47 ~ 56,000	2000	深褐色 Dark brown	45
	LSS 普通用途 General purpose use	螺栓 Screw	- 40 (25) ~ + 85	10 ~ 450	270 ~ 680,000	3000	黑色 Black	48
	LKS 普通用途, 宽温 General purpose use, 105°C	螺栓 Screw	- 40(25) ~ + 105	10 ~ 400	220 ~ 680,000	2000	深褐色 Dark brown	50

產品體系圖 Series Chart

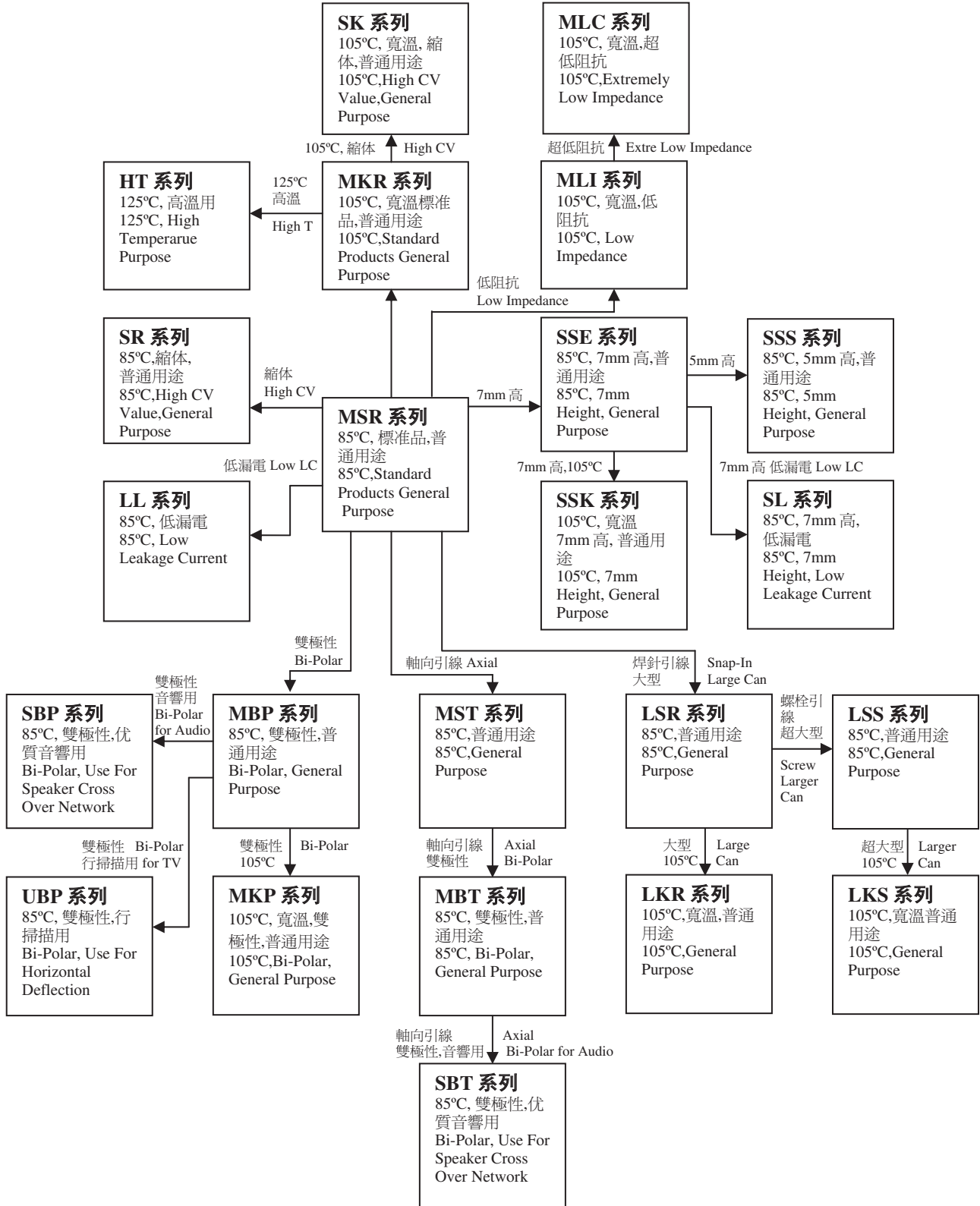



铝电解电容器使用注意事项

Guidelines for Application of Aluminum Electrolytic Capacitors

1. 有极性电解电容器

电解电容器适用于直流(DC)电路,使用时应注意电解电容器的极性标志.如果反极安装,可能会导致短路或防爆线开裂等等故障.

2. 双极性电解电容器

使用时,如果希望改变电压方向或者电压方向未知时,应使用双极性电解电容器.但是双极性电解电容器也不适用于交流(AC)电路.

3. 使用电压

使用的直流电压(DC)应低于电解电容器的额定电压,叠加纹波电压后不能超过额定直流电压.虽然样本中给出了超过额定电压的浪涌电压,但仅限于短时间使用.

4. 纹波电流

过高的纹波电流(RC)会导致电解电容器发热,容量降低或损坏.建议在额定纹波电流的80%以下使用.不同的使用频率对应不同的纹波电流,利用频率乘积系数可以算出与基本纹波电流相对应的数值.

5. 使用温度范围

电解电容器的特性随温度变化,温度升高可以使电容量,漏电流增大,损失角($\tan\delta$)减少,使用寿命缩短.较低的工作温度有利于延长电解电容器的使用寿命.环境温度每升高 10°C ,寿命约减少一半.

6. 使用频率

电解电容器的容量通常在120Hz测量,频率升高会导致电容量减少,损失角($\tan\delta$)增加,温度上升.在高频下使用请定购适合高频线路的电解电容器.

7. 快速充放电

不要将普通的电解电容器用在需要周期性快速深度充放电的电路中,频繁的快速深度充放电可能会导致电容量降低,发热,寿命缩短.在此情况下应使用特别设计的电解电容器.

8. 电容器的安装

应避免过大的外力加到电容器的引线和端子上,这可能会引起漏电流增大,电解液外漏,短路或开路等情况发生.尽量使电容器的脚距与安装孔距一致.如果不一致,使用

1. Polarized Capacitor

These capacitors are suitable for DC circuits. Identify correctly the polarity of the capacitor before use. Incorrect application of polarity may cause short circuit or venting.

2. Bi-Polar Capacitors

Bi-polar type of capacitor is for a circuit where the polarity is occasionally reversed. However, take note that a bi-polar capacitor should not be used for AC voltage application.

3. Operating Voltage

Do not apply a DC voltage which exceeds the rated voltage. The peak voltage of a superimposed (ripple current) on the DC capacitor must not exceed the rated voltage.

A surge voltage value which exceeds the full rated voltage is prescribed in the catalog, but the application should be restricted to short period of time.

4. Ripple Current

Ripple current exceeding the permissible value will cause heat on the capacitor, and may decrease the capacitance or damage the capacitor.

Ripple current on the capacitor must be at or below allowable level. Generally, not more than 80% of the rated current. There is a specified rated ripple current correspond to the ripple frequency. The rated ripple current at a certain frequency must be calculated by multiplying the rated ripple current by a factor.

5. Operating Temperature Range

The characteristics of capacitors change with the operating temperature. The capacitance and leakage current increase and dissipation factor decreases at higher temperature. The use of a capacitor exceeding the maximum rated temperature will considerably shorten the life or cause the capacitor to vent. Usage at lower temperature can ensure longer lifetime. The lifetime is approximately halved with each 10°C rise in ambient temperature.

6. Operating Frequency

The capacitance of the electrolytic capacitors is usually measured at 120Hz. However, the capacitance will decrease and dissipation factor increases as the applied frequency becomes higher. If a capacitor is to be used at higher frequency, you may need a specially designed capacitor that is suitable for the purpose. Please contact our technical team.

7. Charge and Discharge

Do not use the general purpose capacitors in circuits where frequent heavy charge and discharge cycles are required. Frequent, sharp, heavy, charge and discharge cycles will result in decrease in capacitance and damage to the capacitor due to the excessive generated heat. Specific capacitors can be designed to meet the requirements of charging and discharging cycles. Please tell us your requirement.

8. Installing Capacitors

The excessive external force applied to terminals or lead wires may cause high leakage current, short /open circuit or leakage of electrolytic liquid. Make sure that the leads spacing of the capacitor matches the hole spacing of the PC board prior to installation.

鋁電解電容器

Aluminum Electrolytic Capacitor

预先成形的电容器, 应注意避免下列受力情况:

If the terminals spacing of a capacitor does not fit the hole spacing of the PC board, adjust the terminals carefully so as not to cause mechanical stress to the capacitors. The following are typical examples of stress to capacitors that should be avoided:

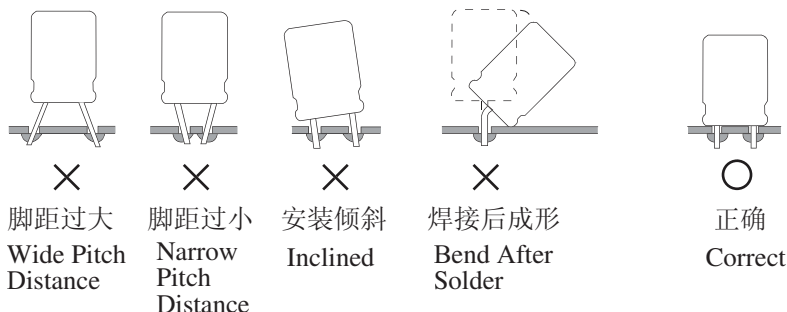

9. 焊接温度和持续时间

9.1 波峰焊

为避免电解电容器胶管破裂和内部伤害, 波峰焊的温度在小于 260°C, 持续时间小于 10 秒, 避免焊锡接触到电容器表面。

9.2 手工焊

手工焊的温度小于 350°C, 持续时间小于 4 秒, 避免电烙铁接触到电解电容器壳体上, 不要焊接后再成形导线

9. Soldering Temperature

9.1 Flow soldering (wave solder)

To avoid crack sleeve and damage to capacitor, the recommended solder temperature should be within $\leq 260^{\circ}\text{C}$ and at a duration of ≤ 10 seconds. Avoid having flux on any surfaces except on the terminals and contact points between the board and the aluminum capacitor.

9.2 Hand soldering

Recommended solder temperature is at $\leq 350^{\circ}\text{C}$ and the duration at ≤ 4 seconds. Prevent the solder iron from touching any portion of the capacitor body.

10. 焊接后的清洗

避免使用卤化物或类似的溶剂清洗线路板, 如三氯乙烯, 二甲苯或酮类等. 建议使用醇类溶剂作为洗涤剂。

10. Cleaning after Soldering

To prevent damage to sleeve, markings and sealing materials, the capacitor should never be washed with halogenous solvents such as trichlorethylene, xylene or acetone and the like. Recommended cleaning solvents are methanol, isopropanol, ethanol, isobutanol, petroleumether, propanol and commercial detergents.

11. 存放和加电压处理

长期存放后, 电解电容器的漏电会增加. 为避免漏电增加引起的发热或其它故障, 建议对在室温下存放超过 2 年的电容器进行加电压处理. 给电容器逐渐升高直流电压(DC)到额定值, 然后保持此电压到漏电流降到规定值以下。

11. Storage and Voltage Treatment

During long storage, DC leakage current of aluminum electrolytic capacitors will increase. In order to prevent heat rise and high DC leakage current, voltage treatment is recommended especially for capacitor which have been stored for more than 2 years at room temperature.

The capacitors shall be applied with DC voltage, increasing it gradually to the rated voltage at room temperature. The voltage shall be maintained until DC leakage current comes down to the specified value or less.

12. 防爆线

电解电容器工作时, 不要将眼睛靠近防爆线观察, 以免防爆线动作后, 释放出超过 100°C 的高温气体伤害眼睛. 防爆线起作用时会放出气体, 应在防爆线上方预留空间, 不要在防爆线上方布置电路或导线. 推荐的距离如下:

12. Safety Vent

When venting, a capacitor gives out gas with a temperature of over 100°C. Protect your face and eyes when working on the capacitors.

In the case of a short-circuit, the aluminum electrolytic capacitor will vent and expel gas. It is suggested to provide sufficient space between the vent of capacitor with the cover or adjacent components. There should not be any conductive material placed above the safety vent. The following spacing is recommended:

直径 Diameter \varnothing (mm)	6.3~16	18~35	40 及以上 and above
最小预留空间 Min Space (mm)	2	3	5

鋁電解電容器

Aluminum Electrolytic Capacitor

怎样订购电解电容器

How to Order Aluminum Electrolytic Capacitors

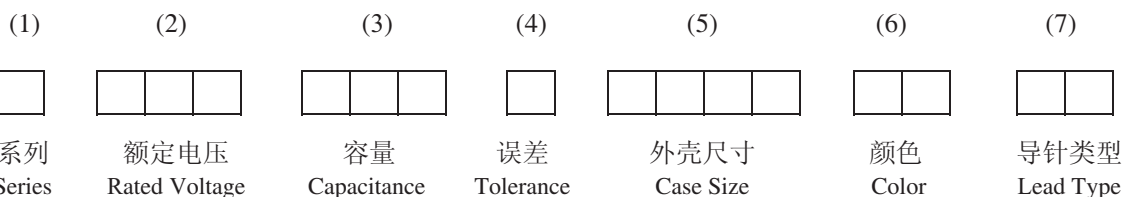

代码 Code	系列 Series
A	MSR
B	MKR
C	SR
D	SK
E	SSE
F	SSK
G	LL
H	MBP
R	MKP
J	SBP
K	UBP
L	HT
M	MLI
N	MLC
P	SL
S	SSS
W	LSR
Y	LKR
TA	MST
TH	MBT
TJ	SBT
WS	LSS
YS	LKS

代码 Code	电压 (V)
050	50

代码 Code	电容量 (μ F)
474	0.47
475	4.7
476	47
477	470
478	4700
479	47000

代码 Code	容量误差 (%)
K	± 10
M	± 20
V	-10~+20
Q	-10~+30
T	-10~+50
A	特殊 Special

代码 Code	外壳尺寸 Case Size
1020	$\varnothing 10 \times L20$

代码 Code	颜色 Color
BK	黑色 Black
BL	蓝色 Blue
LB	浅蓝色 Light blue
DG	深绿色 Dark green
GY	灰色 Grey
DB	深蓝色 Dark blue
YW	黄色 Yellow
OE	橙色 Orange
DR	深褐色 Dark brown
RD	红色 Red
BP	蓝紫色 Blue purple
DP	深紫色 Dark purple
LP	浅紫色 Light purple

代码 Code	导针类型 Lead type
L	散装 Loose Packing
LL	散装(长脚) Loose Packing, long lead
CC	直切 Straight cut
FC	成形切 Forming cut
MC	锁扣式直切 Snap-in cut
FM	锁扣式成形切 Snap-in forming cut
T	编带(脚距 5 mm) Taping (pitch 5mm)
TT	编带(脚距 3.5 mm) Taping (pitch 3.5mm)
TF	编带(脚距 2.5 mm) Taping (pitch 2.5mm)
SP	焊针引线 Snap-in
SW	螺栓引线 Screw

例 Example :

A 050 105 M 0511 BK L

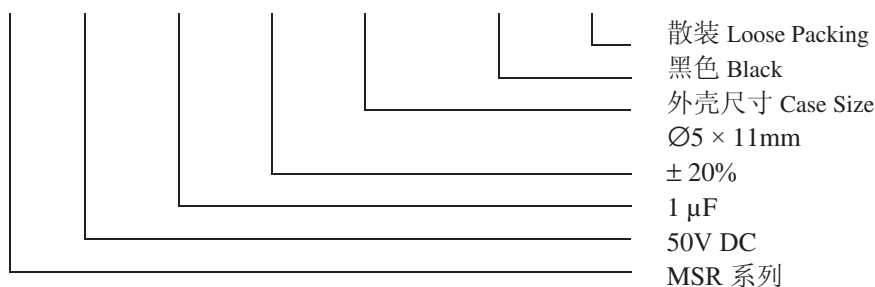

注：样本中规定的容量和尺寸可作为选用参考，也可按要求提供其它容量和尺寸。当有特别要求时，请尽量告之下列事项，以便为您提供恰当服务：

Note: All specifications indicated in this catalogue are standard and for reference purposes only. Other specifications will be provided upon request. Request for other specific capacitor should contain the following informations:

1. 容量和容量允许偏差； Capacitance and capacitance tolerance;
2. 使用温度范围； Operating temperature range;
3. 额定工作电压； Rated working voltage;
4. 阻抗和纹波电流； Impedance and ripple current;
5. 结构形式和极限尺寸； Terminal type and permitted maximum case size;
6. 用途； Application;
7. 其它特定技术条件. Other special specifications, if any.

成形和切導針

Lead Cut and Forming

單位 Unit : mm

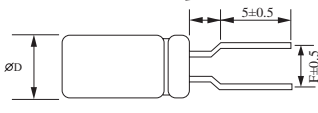
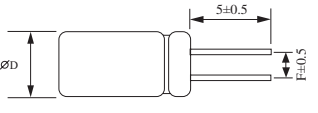
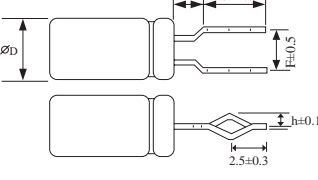
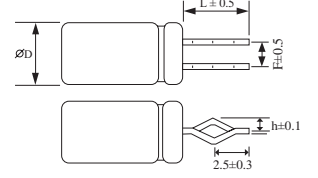
剪切类型 Type	代码 Code	形状 Shape	尺寸 Dimensions																								
成形切 Forming Cut	FC	<p>7mmL, 1.5max 其它系列 Others, 2.5max</p> 	<table border="1"> <tr> <td>ØD</td> <td>4</td> <td>5</td> <td>6.3</td> <td>8</td> </tr> <tr> <td>F</td> <td>5.0</td> <td>5.0</td> <td>5.0</td> <td>5.0</td> </tr> </table>	ØD	4	5	6.3	8	F	5.0	5.0	5.0	5.0														
ØD	4	5	6.3	8																							
F	5.0	5.0	5.0	5.0																							
直切 Straight Cut	CC		<table border="1"> <tr> <td>ØD</td> <td>4</td> <td>5</td> <td>6.3</td> <td>8</td> <td>10</td> </tr> <tr> <td>F</td> <td>1.5</td> <td>2.0</td> <td>2.5</td> <td>3.5</td> <td>5.0</td> </tr> </table> <table border="1"> <tr> <td>ØD</td> <td>13</td> <td>16</td> <td>18</td> <td>22</td> </tr> <tr> <td>F</td> <td>5.0</td> <td>7.5</td> <td>7.5</td> <td>10.0</td> </tr> </table>	ØD	4	5	6.3	8	10	F	1.5	2.0	2.5	3.5	5.0	ØD	13	16	18	22	F	5.0	7.5	7.5	10.0		
ØD	4	5	6.3	8	10																						
F	1.5	2.0	2.5	3.5	5.0																						
ØD	13	16	18	22																							
F	5.0	7.5	7.5	10.0																							
锁扣式成形切 Snap-in Forming Cut	FM	<p>7mmL, 1.5max 其它系列 Others, 2.5max</p> 	<table border="1"> <tr> <td>ØD</td> <td>4</td> <td>5</td> <td>6.3</td> <td>8</td> </tr> <tr> <td>F</td> <td>5.0</td> <td>5.0</td> <td>5.0</td> <td>5.0</td> </tr> <tr> <td>h</td> <td>1.1</td> <td>1.1</td> <td>1.1</td> <td>1.3</td> </tr> </table>	ØD	4	5	6.3	8	F	5.0	5.0	5.0	5.0	h	1.1	1.1	1.1	1.3									
ØD	4	5	6.3	8																							
F	5.0	5.0	5.0	5.0																							
h	1.1	1.1	1.1	1.3																							
锁扣式直切 Snap-in Cut	MC		<table border="1"> <tr> <td>ØD</td> <td>10</td> <td>13</td> <td>16</td> <td>18</td> <td>22</td> </tr> <tr> <td>F</td> <td>5.0</td> <td>5.0</td> <td>7.5</td> <td>7.5</td> <td>10.0</td> </tr> <tr> <td>h</td> <td>1.3</td> <td>1.3</td> <td>1.3</td> <td>1.3</td> <td>1.8</td> </tr> <tr> <td>L</td> <td>4.5</td> <td>4.5</td> <td>4.5</td> <td>4.5</td> <td>5.0</td> </tr> </table>	ØD	10	13	16	18	22	F	5.0	5.0	7.5	7.5	10.0	h	1.3	1.3	1.3	1.3	1.8	L	4.5	4.5	4.5	4.5	5.0
ØD	10	13	16	18	22																						
F	5.0	5.0	7.5	7.5	10.0																						
h	1.3	1.3	1.3	1.3	1.8																						
L	4.5	4.5	4.5	4.5	5.0																						

注：除了标准剪切长度外，也可按要求提供其它长度。

Note: Other cut length of lead wire can be supplied upon customer's request.

编带和包装

Taping Specifications

编带规格

单位 Unit: mm

图 1 F = 5.0		外壳尺寸 Case Size						
项目 Item		Ø4x7	Ø5x7	Ø6.3x7	Ø5x11	Ø6.3x11 Ø6.3x15	Ø8x11 Ø8x15 Ø8x20	
Ød 导针直径	±0.05	0.45	0.45	0.45	0.50	0.50	0.60	
F 导针与导针距离	+0.8 -0.2	5.0	5.0	5.0	5.0	5.0	5.0	
F1 祇孔中心与导针距离	±0.5	3.85	3.85	3.85	3.85	3.85	3.85	
K 导针折弯高度	max	1.5	1.5	1.5	2.5	2.5	4.0	
H0 导针折弯距祇孔高度	±0.5	16.0	16.0	16.0	16.0	16.0	16.0	
H 祇孔中心与壳底距离	+0.75 -0.50	17.5	17.5	17.5	18.5	18.5	20.0	

图 2 F = 2.5		外壳尺寸 Case Size		
项目 Item		Ø4x7	Ø5x7	Ø5x11
Ød 导针直径	±0.05	0.45	0.45	0.50
F 导针与导针距离	+0.8 -0.2	2.5	2.5	2.5
F1 祇孔中心与导针距离	±0.5	5.1	5.1	5.1
H 祇孔中心与壳底距离	+0.75 -0.50	18.5	18.5	18.5

图 3 F = 2.5 F = 3.5 F = 5.0		外壳尺寸 Case Size			
项目 Item		Ø6.3 x7	Ø6.3	Ø8	Ø10
Ød 导针直径	±0.05	0.45	0.50	0.60	0.60
F 导针与导针距离	+0.8 -0.2	2.5	2.5	3.5	5.0
F1 祇孔中心与导针距离	±0.5	5.1	5.1	4.6	3.85
H 祇孔中心与壳底距离	+0.75 -0.50	18.5	18.5	18.5	18.5

鋁電解電容器 Aluminum Electrolytic Capacitor

编带规格

单位 Unit: mm

图 4

F = 5.0

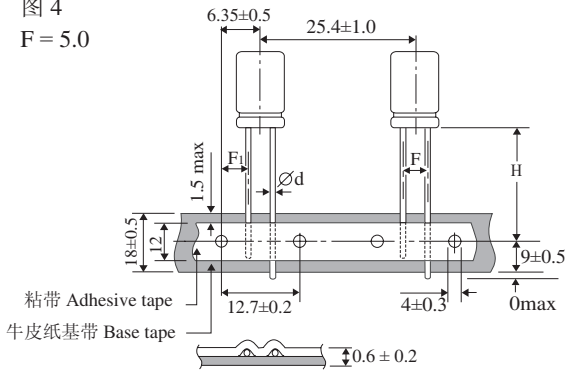

外壳尺寸 Case Size		Ø13
项目 Item		
Ød 导针直径	±0.05	0.60
F 导针与导针 距离	+0.8 -0.2	5.0
F1 祇孔中心与 导针距离	±0.5	3.85
H 祇孔中心与 壳底距离	+0.75 -0.50	18.5

包装

瓦楞纸盒
Ammo pack box

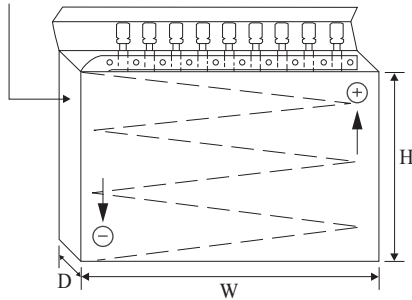

尺寸 Size	H	W	D	数量 Qty (PC)
Ø 4, Ø 5	227	330	50	2000
Ø 6.3 x 11	227	330	50	1500
Ø 6.3 x 15	227	330	60	1500
Ø 8 x 11	227	330	50	1000
Ø 8 x 15	227	330	60	1000
Ø 10 x 12	227	330	50	500
Ø 10 x 16	227	330	60	500
Ø 10 x 20	227	330	65	500
Ø 10 x 25	227	330	65	500
Ø 13 x 20	227	330	60	400
Ø 13 x 25	227	330	65	400

鋁電解電容器

Aluminum Electrolytic Capacitor

SSS 系列

- 外壳高度: 5mm. 5mm Height.
- 适用于特别需要节省空间的场合.
Suitable for Space-Saving Circuits.
- 85°C, 耐久性 2,000 小时.
85°C, Load Life 2000 Hours.



项目 Item	特性 Specifications																	
工作温度范围 Temperature Range	-40 ~ +85°C																	
容量允许误差 Capacitance Tolerance	±20% (M) (在 20°C, 120 Hz)																	
最大泄漏电流 Leakage Current	2 分钟后, 0.01CV (µA) 或 3 µA, 取较大值 (在 20°C) After 2 minutes, 0.01CV (µA) or 3 µA, whichever is greater (at 20°C)																	
最大损失角正切 Dissipation Factor	<table border="1"> <thead> <tr> <th>额定电压 (V) Rated Voltage</th> <th>4</th> <th>6.3</th> <th>10</th> <th>16</th> <th>25</th> <th>35</th> <th>50</th> </tr> </thead> <tbody> <tr> <td>损失角 (tan δ) D.F</td> <td>0.35</td> <td>0.24</td> <td>0.20</td> <td>0.16</td> <td>0.14</td> <td>0.12</td> <td>0.10</td> </tr> </tbody> </table>	额定电压 (V) Rated Voltage	4	6.3	10	16	25	35	50	损失角 (tan δ) D.F	0.35	0.24	0.20	0.16	0.14	0.12	0.10	(在 20°C, 120 Hz)
额定电压 (V) Rated Voltage	4	6.3	10	16	25	35	50											
损失角 (tan δ) D.F	0.35	0.24	0.20	0.16	0.14	0.12	0.10											
耐久性 Load Life	电容器在 85°C 环境中施加额定电压连续 2,000 小时后, 冷却至 20°C 测量, 特性应满足: The following specifications shall be satisfied when the capacitors are restored to 20°C after the rated voltage is applied for 2,000 hours at 85°C	<table border="1"> <tbody> <tr> <td>容量变化 Capacitance Change</td> <td>初始值±20% 以内 ≤ ±20% of the initial value</td> </tr> <tr> <td>损失角 (tan δ) Dissipation Factor</td> <td>小于初始规定值的 200% ≤ 200% of the initial specified value</td> </tr> <tr> <td>泄漏电流 Leakage Current</td> <td>小于初始规定值 ≤ the initial specified value</td> </tr> </tbody> </table>	容量变化 Capacitance Change	初始值±20% 以内 ≤ ±20% of the initial value	损失角 (tan δ) Dissipation Factor	小于初始规定值的 200% ≤ 200% of the initial specified value	泄漏电流 Leakage Current	小于初始规定值 ≤ the initial specified value										
容量变化 Capacitance Change	初始值±20% 以内 ≤ ±20% of the initial value																	
损失角 (tan δ) Dissipation Factor	小于初始规定值的 200% ≤ 200% of the initial specified value																	
泄漏电流 Leakage Current	小于初始规定值 ≤ the initial specified value																	
其它 Others	满足 JIS C5141 之 W 项. Satisfies characteristic W of JIS C5141																	

图形和尺寸 Figure and Dimensions

单位 Unit: mm

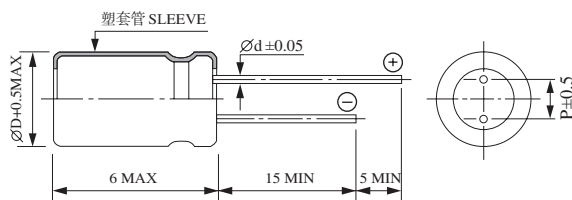

∅D	4	5	6.3
∅d	0.45	0.45	0.45
P	1.5	2.0	2.5

外壳尺寸和最大纹波电流 Case Size and Rated Ripple Current

V µF	4	6.3	10	16	25	35	50
0.1							4x5 1.0
0.22							4x5 2.0
0.33							4x5 2.8
0.47							4x5 4.0
1.0							4x5 8.4
2.2							4x5 13
3.3						4x5 15	4x5 17
4.7					4x5 16	4x5 18	5x5 20
10				4x5 23	5x5 27	5x5 29	6.3x5 33
22		4x5 28	5x5 33	5x5 37	6.3x5 42	6.3x5 46	
33	4x5 28	5x5 37	5x5 41	6.3x5 49	6.3x5 52		
47	4x5 33	5x5 45	6.3x5 52	6.3x5 58			
100	5x5 56	6.3x5 70					
220	6.3x5 96						

纹波电流 R.C (mA rms) 在 85°C, 120Hz
外壳尺寸 Case Size ∅DxL (mm)



鋁電解電容器 Aluminum Electrolytic Capacitor

SSE 系列

- 外壳高度: 7mm. 7mm Height.
- 适用于特别需要节省空间的场合.
Suitable for Space-Saving Circuits.
- 85°C, 耐久性 2,000 小时. 85°C, Load Life 2000 Hours.



项目 Item	特性 Specifications	
工作温度范围 Temperature Range	-40 ~ +85°C	
容量允许误差 Capacitance Tolerance	± 20% (M) (在 20°C, 120 Hz)	
最大泄漏电流 Leakage Current	2 分钟后, 0.01CV (μA) 或 3 μA, 取较大值 (在 20°C) After 2 minutes, 0.01CV (μA) or 3 μA, whichever is greater (at 20°C)	
最大损失角正切 Dissipation Factor	额定电压 (V) Rated Voltage	4 6.3 10 16 25 35 50 63
	损失角 (tan δ) D.F.	0.35 0.24 0.20 0.16 0.14 0.12 0.10 0.09
耐久性 Load Life	电容器在 85°C 环境中施加额定电压连续 2,000 小时后, 冷却至 20°C 测量, 特性应满足: The following specifications shall be satisfied when the capacitors are restored to 20°C after the rated voltage is applied for 2,000 hours at 85°C	
	容量变化 Capacitance Change	初始值± 20% 以内 ≤ ± 20% of the initial value
	损失角 (tan δ) Dissipation Factor	小于初始规定值的 200% ≤ 200% of the initial specified value
	泄漏电流 Leakage Current	小于初始规定值 ≤ the initial specified value
其它 Others	满足 JIS C5141 之 W 项. Satisfies characteristic W of JIS C5141	

图形和尺寸 Figure and Dimensions

单位 Unit: mm

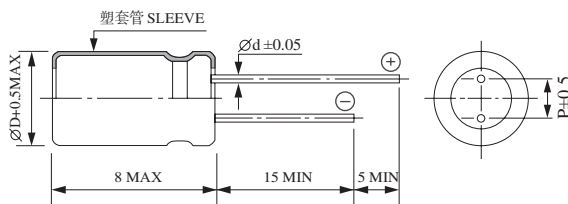

∅D	4	5	6.3
∅d	0.45	0.45	0.45
P	1.5	2.0	2.5

外壳尺寸和最大纹波电流 Case Size and Rated Ripple Current

V μF	4	6.3	10	16	25	35	50	63
0.1							4x7 4.4	4x7 4.9
0.15							4x7 5.4	4x7 6.0
0.22							4x7 6.6	4x7 7.3
0.33							4x7 8.0	4x7 8.9
0.47							4x7 10	4x7 11
0.68							4x7 12	4x7 13
1.0							4x7 14	4x7 15
1.5							4x7 17	4x7 19
2.2							4x7 21	4x7 23
3.3						4x7 23	4x7 25	4x7 27
4.7					4x7 25	4x7 27	4x7 30	5x7 33
6.8				4x7 29	4x7 31	4x7 33	4x7 37	5x7 40
10			4x7 31	4x7 35	4x7 37	4x7 40	5x7 51	6.3x7 57
15			4x7 38	4x7 43	4x7 46	5x7 57	6.3x7 72	
22		4x7 35	4x7 46	4x7 52	5x7 64	5x7 69		
33	4x7 43	4x7 42	4x7 57	5x7 73	5x7 78	6.3x7 98		
47	4x7 51	4x7 52	5x7 78	5x7 87	6.3x7 108			
68	5x7 71	5x7 62	5x7 94	6.3x7 122				
100	5x7 86	5x7 86	6.3x7 132	6.3x7 148				
150	6.3x7 122	6.3x7 104	6.3x7 162					
220	6.3x7 148	6.3x7 179						

纹波电流 R.C (mA rms) 在 85°C, 120Hz
外壳尺寸 Case Size ∅DxL (mm)

鋁電解電容器

Aluminum Electrolytic Capacitor

SSK 系列

- 外壳高度: 7mm. 7mm Height.
- 适用于特别需要节省空间的场合.
Suitable for Space-Saving Circuits.
- 105°C, 耐久性 1,000 小时.
105°C, Load Life 1000 Hours.



项目 Item	特性 Specifications																	
工作温度范围 Temperature Range	-55 ~ +105°C																	
容量允许误差 Capacitance Tolerance	± 20% (M) (在 20°C, 120 Hz)																	
最大泄漏电流 Leakage Current	2 分钟后, 0.01CV (μA) 或 3 μA, 取较大值. (在 20°C) After 2 minutes, 0.01CV (μA) or 3 μA, whichever is greater. (at 20°C)																	
最大损失角正切 Dissipation Factor	<table border="1"> <tr> <td>额定电压 (V) Rated Voltage</td> <td>6.3</td> <td>10</td> <td>16</td> <td>25</td> <td>35</td> <td>50</td> <td>63</td> </tr> <tr> <td>损失角 (tan δ) D.F</td> <td>0.24</td> <td>0.20</td> <td>0.16</td> <td>0.14</td> <td>0.12</td> <td>0.10</td> <td>0.09</td> </tr> </table>	额定电压 (V) Rated Voltage	6.3	10	16	25	35	50	63	损失角 (tan δ) D.F	0.24	0.20	0.16	0.14	0.12	0.10	0.09	(在 20°C, 120 Hz)
额定电压 (V) Rated Voltage	6.3	10	16	25	35	50	63											
损失角 (tan δ) D.F	0.24	0.20	0.16	0.14	0.12	0.10	0.09											
耐久性 Load Life	电容器在 105°C 环境中施加额定电压连续 1,000 小时后, 冷却至 20°C 测量, 特性应满足: The following specifications shall be satisfied when the capacitors are restored to 20°C after the rated voltage is applied for 1,000 hours at 105°C	<table border="1"> <tr> <td>容量变化 Capacitance Change</td> <td>初始值± 20% 以内 ≤ ± 20% of the initial value</td> </tr> <tr> <td>损失角 (tan δ) Dissipation Factor</td> <td>小于初始规定值的 200% ≤ 200% of the initial specified value</td> </tr> <tr> <td>泄漏电流 Leakage Current</td> <td>小于初始规定值 ≤ the initial specified value</td> </tr> </table>	容量变化 Capacitance Change	初始值± 20% 以内 ≤ ± 20% of the initial value	损失角 (tan δ) Dissipation Factor	小于初始规定值的 200% ≤ 200% of the initial specified value	泄漏电流 Leakage Current	小于初始规定值 ≤ the initial specified value										
容量变化 Capacitance Change	初始值± 20% 以内 ≤ ± 20% of the initial value																	
损失角 (tan δ) Dissipation Factor	小于初始规定值的 200% ≤ 200% of the initial specified value																	
泄漏电流 Leakage Current	小于初始规定值 ≤ the initial specified value																	
其它 Others	满足 JIS C5141 之 W 项. Satisfies characteristic W of JIS C5141																	

图形和尺寸 Figure and Dimensions

单位 Unit: mm

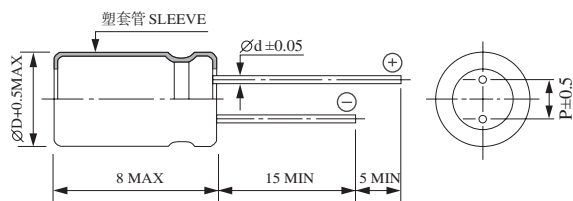

ØD	4	5	6.3
Ød	0.45	0.45	0.45
P	1.5	2.0	2.5

外壳尺寸和最大纹波电流 Case Size and Rated Ripple Current

V μF	6.3	10	16	25	35	50	63
0.1						4x7 1.0	4x7 1.0
0.15						4x7 1.9	4x7 1.9
0.22						4x7 2.3	4x7 2.3
0.33						4x7 3.5	4x7 3.6
0.47						4x7 5.0	4x7 5.2
0.68						4x7 8.2	4x7 8.6
1.0						4x7 10	4x7 10
1.5						4x7 15	4x7 16
2.2						4x7 19	4x7 20
3.3					4x7 20	4x7 24	5x7 25
4.7				4x7 22	4x7 24	5x7 29	5x7 30
6.8			4x7 24	4x7 26	4x7 28	5x7 34	6.3x7 41
10		4x7 26	4x7 29	5x7 33	5x7 36	6.3x7 44	
15	4x7 28	4x7 31	4x7 35	5x7 40	5x7 44		
22	4x7 34	5x7 38	5x7 44	6.3x7 51	6.3x7 57		
33	5x7 42	5x7 47	6.3x7 57	6.3x7 63			
47	5x7 50	6.3x7 59	6.3x7 68				
68	5x7 60	6.3x7 71					
100	6.3x7 77	6.3x7 86					
220	6.3x7 114						

纹波电流 R.C (mA rms) 在 105°C, 120Hz
外壳尺寸 Case Size ØDxL (mm)

鋁電解電容器

Aluminum Electrolytic Capacitor

SL 系列

- 低泄漏电流. Low Leakage Current.
- 外壳高度: 7mm. 7mm Height.
- 适用于特别需要节省空间的场合. Suitable for Space-Saving Circuits.
- 85°C, 耐久性 1,000 小时. 85°C, Load Life 1,000 Hours.



项目 Item	特性 Specifications	
工作温度范围 Temperature Range	-40 ~ +85°C	
容量允许误差 Capacitance Tolerance	± 20% (M) (在 20°C, 120 Hz)	
最大泄漏电流 Leakage Current	2 分钟后, 0.002CV (μA) 或 0.4 μA, 取较大值. (在 20°C) After 2 minutes, 0.002CV (μA) or 0.4 μA, whichever is greater. (at 20°C)	
最大损失角正切 Dissipation Factor	额定电压 (V) Rated Voltage	6.3 10 16 25 35 50
	损失角 (tan δ) D.F	0.24 0.20 0.16 0.14 0.12 0.10
耐久性 Load Life	电容器在 85°C 环境中施加额定电压连续 1,000 小时后, 冷却至 20°C 测量, 特性应满足: The following specifications shall be satisfied when the capacitors are restored to 20°C after the rated voltage is applied for 1,000 hours at 85°C	
	容量变化 Capacitance Change	初始值± 20% 以内 ≤ ± 20% of the initial value
	损失角 (tan δ) Dissipation Factor	小于初始规定值的 200% ≤ 200% of the initial specified value
	泄漏电流 Leakage Current	小于初始规定值 ≤ the initial specified value
其它 Others	满足 JIS C5141 之 W 项. Satisfies characteristic W of JIS C5141.	

图形和尺寸 Figure and Dimensions

单位 Unit: mm

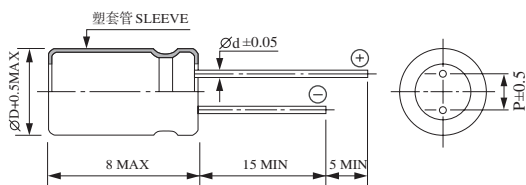

ØD	4	5	6.3
Ød	0.45	0.45	0.45
P	1.5	2.0	2.5

外壳尺寸和最大纹波电流 Case Size and Rated Ripple Current

V	6.3		10		16		25		35		50		
μF													
0.1											4x7	1.0	
0.15											4x7	1.9	
0.22											4x7	2.3	
0.33											4x7	3.5	
0.47											4x7	5.0	
0.68											4x7	8.2	
1.0											4x7	10	
1.5											4x7	15	
2.2											4x7	19	
3.3										4x7	20	4x7	24
4.7							4x7	22	4x7	24	5x7	29	
6.8					4x7	24	4x7	26	5x7	29	5x7	34	
10			4x7	26	4x7	29	5x7	33	5x7	36	6.3x7	44	
15	4x7	28	4x7	31	5x7	36	5x7	40	6.3x7	47			
22	4x7	34	5x7	38	5x7	44	6.3x7	51	6.3x7	57			
33	5x7	42	5x7	47	6.3x7	57	6.3x7	63					
47	5x7	50	6.3x7	59	6.3x7	68							
68	6.3x7	63	6.3x7										
100	6.3x7	77											

纹波电流 R.C (mA rms) 在 85°C, 120Hz
外壳尺寸 Case Size ØDxL (mm)

鋁電解電容器

Aluminum Electrolytic Capacitor

MSR 系列

标准系列, 普通用途. Standard Series, General Use.

- 85°C, 耐久性 5,000 小时.
(Ø5, Ø6.3 为 3,000 小时, Ø8 为 4,000 小时)
- 85°C, Load Life: 5,000 Hours.
(Ø5, Ø6.3: 3,000 Hours, Ø8: 4,000 Hours)



项目 Item	特性 Specifications																						
额定工作电压 Rated Working Voltage	6.3 ~ 450 V																						
工作温度范围 Temperation Range	-40 ~ +85°C (6.3 ~ 350V), -25 ~ +85°C (400 ~ 450V)																						
容量允许误差 Capacitance Tolerance	± 20% (在 20°C, 120 Hz)																						
最大泄漏电流 Leakage Current (在 20°C)	<table border="1"> <tr> <th>额定电压 Rated Voltage</th> <th colspan="2">≤ 100V</th> <th colspan="2">> 100V</th> </tr> <tr> <th>充电时间 Charge Time</th> <td>1 分钟 1 minute</td> <td>2 分钟 2 minute</td> <td colspan="2">1 分钟 1 minute</td> </tr> <tr> <th>泄漏电流 Leakage Current</th> <td>0.03CV 或 4µA 取较大值 0.03CV or 4µA whichever is greater</td> <td>0.01CV 或 3µA 取较大值 0.01CV or 3µA whichever is greater</td> <td>CV ≤ 1000</td> <td>CV > 1000</td> </tr> <tr> <td></td> <td></td> <td></td> <td>0.1CV + 40 (µA)</td> <td>0.04CV + 100 (µA)</td> </tr> </table>	额定电压 Rated Voltage	≤ 100V		> 100V		充电时间 Charge Time	1 分钟 1 minute	2 分钟 2 minute	1 分钟 1 minute		泄漏电流 Leakage Current	0.03CV 或 4µA 取较大值 0.03CV or 4µA whichever is greater	0.01CV 或 3µA 取较大值 0.01CV or 3µA whichever is greater	CV ≤ 1000	CV > 1000				0.1CV + 40 (µA)	0.04CV + 100 (µA)		
	额定电压 Rated Voltage	≤ 100V		> 100V																			
	充电时间 Charge Time	1 分钟 1 minute	2 分钟 2 minute	1 分钟 1 minute																			
泄漏电流 Leakage Current	0.03CV 或 4µA 取较大值 0.03CV or 4µA whichever is greater	0.01CV 或 3µA 取较大值 0.01CV or 3µA whichever is greater	CV ≤ 1000	CV > 1000																			
			0.1CV + 40 (µA)	0.04CV + 100 (µA)																			
最大损失角正切 Dissipation Factor	<table border="1"> <tr> <th>额定电压 (V) Rated Voltage</th> <td>6.3</td> <td>10</td> <td>16</td> <td>25</td> <td>35</td> <td>50</td> <td>63</td> <td>100</td> <td>160~250</td> <td>350~450</td> </tr> <tr> <th>损失角 (tan δ) D.F.</th> <td>0.24</td> <td>0.20</td> <td>0.16</td> <td>0.14</td> <td>0.12</td> <td>0.10</td> <td>0.09</td> <td>0.08</td> <td>0.15</td> <td>0.20</td> </tr> </table>	额定电压 (V) Rated Voltage	6.3	10	16	25	35	50	63	100	160~250	350~450	损失角 (tan δ) D.F.	0.24	0.20	0.16	0.14	0.12	0.10	0.09	0.08	0.15	0.20
	额定电压 (V) Rated Voltage	6.3	10	16	25	35	50	63	100	160~250	350~450												
损失角 (tan δ) D.F.	0.24	0.20	0.16	0.14	0.12	0.10	0.09	0.08	0.15	0.20													
	注: 电容器容量超过 1,000µF 后, 每增加 1,000µF, 损失角 (tan δ) 增加 0.02. (在 20°C, 120 Hz) Note: For capacitance of more than 1,000µF, the value of D.F should be added 0.02 for every increase of 1,000µF.																						
耐久性 Load Life	电容器在 85°C 环境中施加额定电压连续 5,000 小时 (Ø5, Ø6.3 为 3,000 小时, Ø8 为 4,000 小时) 后, 冷却至 20°C 测量, 特性应满足: The following specifications shall be satisfied when the capacitors are restored to 20°C after the rated voltage is applied for 5,000 hours at 85°C (Ø5, Ø6.3: 3,000 hours, Ø8: 4,000hours)																						
	<table border="1"> <tr> <th>容量变化 Capacitance Change</th> <td>± 20% 以内 ≤ ± 20% of the initial value</td> </tr> <tr> <th>损失角 (tan δ) D.F.</th> <td>小于初始规定值的 200% ≤ 200% of the initial specified value</td> </tr> <tr> <th>泄漏电流 Leakage Current</th> <td>小于初始规定值 ≤ the initial specified value</td> </tr> </table>	容量变化 Capacitance Change	± 20% 以内 ≤ ± 20% of the initial value	损失角 (tan δ) D.F.	小于初始规定值的 200% ≤ 200% of the initial specified value	泄漏电流 Leakage Current	小于初始规定值 ≤ the initial specified value																
	容量变化 Capacitance Change	± 20% 以内 ≤ ± 20% of the initial value																					
损失角 (tan δ) D.F.	小于初始规定值的 200% ≤ 200% of the initial specified value																						
泄漏电流 Leakage Current	小于初始规定值 ≤ the initial specified value																						
其它 Others	满足 JIS C5141 之 W 项规定 Satisfies characteristic W of JIS C5141																						

图形和尺寸 Figure and Dimensions

单位 Unit: mm

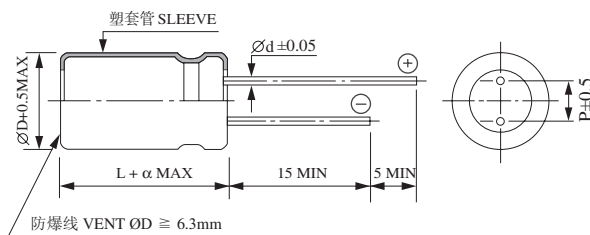

ØD	5	6.3	8	10	13	16	18	22
Ød	0.5	0.5	0.6	0.6	0.6	0.8	0.8	1.0
P	2.0	2.5	3.5	5.0	5.0	7.5	7.5	10.0
α	1.5			2.0				

纹波电流频率系数

Frequency Multiplying Factor of Ripple Current

V	Hz					
	µF	50	120	300	1K	10K
6.3 ~ 100	~ 68	0.75	1.00	1.35	1.57	2.00
	100 ~ 680	0.80	1.00	1.23	1.34	1.50
	1000 ~ 15000	0.85	1.00	1.10	1.13	1.15
160 ~ 450	0.68 ~ 220	0.80	1.00	1.25	1.40	1.60
	330 ~	0.90	1.00	1.10	1.13	1.15

鋁電解電容器

Aluminum Electrolytic Capacitor

MSR 系列

外壳尺寸和最大纹波电流 Case Size and Rated Ripple Current

V μF	6.3	10	16	25	35	50	63	100	160	200	250	350	400	450
0.1						5x11 7.2		5x11 7.8						
0.15						5x11 8.9		5x11 9.6						
0.22						5x11 11		5x11 12						
0.33						5x11 13		5x11 14						
0.47						5x11 16		5x11 17						
0.68						5x11 19		5x11 20	6.3x11 20	6.3x11 20	6.3x11 20			
1.0						5x11 23		5x11 25	6.3x11 25	6.3x11 25	6.3x11 25	8x11.5 24	8x11.5 29	8x11.5 26
1.5						5x11 28		5x11 30	6.3x11 30	6.3x11 30	8x11.5 36	8x11.5 36	10x12.5 41	10x12.5 37
2.2						5x11 34		5x11 37	6.3x11 37	6.3x11 37	8x11.5 43	10x12.5 50	10x12.5 50	10x12.5 45
3.3						5x11 42		5x11 45	8x11.5 53	8x11.5 53	8x11.5 61	10x12.5 61	10x12.5 61	10x16 60
4.7				5x11 41	5x11 46	5x11 50	5x11 54	5x11 54	8x11.5 63	10x12.5 73	10x12.5 73	10x12.5 73	10x16 80	10x20 78
6.8				5x11 50	5x11 55	5x11 60	5x11 65	6.3x11 74	10x12.5 88	10x12.5 88	10x12.5 88	10x16 96	10x20 105	10x20 94
10			5x11 55	5x11 60	5x11 67	5x11 72	5x11 78	6.3x11 90	10x12.5 107	10x16 117	10x16 117	10x20 128	13x20 150	13x20 135
15			5x11 67	5x11 74	5x11 83	5x11 89	5x11 96	6.3x11 110	10x16 143	10x20 156	10x20 156	13x20 185	13x25 205	13x25 180
22		5x11 73	5x11 82	5x11 90	5x11 100	5x11 108	6.3x11 133	8x11.5 157	10x20 190	10x20 190	13x20 220	13x25 240	13x25 240	16x25 240
33	5x11 83	5x11 89	5x11 100	5x11 109	5x11 123	6.3x11 151	6.3x11 163	10x12.5 224	13x20 270	13x20 270	13x25 300	13x25 300	16x25 320	16x31.5 320
47	5x11 99	5x11 106	5x11 120	5x11 131	6.3x11 169	6.3x11 181	8x11.5 230	10x16 290	13x20 320	13x25 350	16x25 390	16x31.5 430	16x35.5 450	16x35.5 400
68	5x11 120	5x11 128	5x11 144	6.3x11 182	6.3x11 203	8x11.5 250	10x12.5 320	10x16 350	13x25 430	16x25 470	16x25 470	16x35.5 540	18x35.5 580	18x40 550
100	5x11 145	5x11 155	6.3x11 200	6.3x11 220	8x11.5 290	8x11.5 310	10x12.5 390	10x20 470	16x25 570	16x31.5 630	16x35.5 660	18x40 740	22x40 820	22x40 730
150	6.3x11 200	6.3x11 220	6.3x11 245	8x11.5 315	10x12.5 370	10x16 484	10x16 520	13x20 670	16x31.5 770	16x35.5 810	18x40 895	22x40 950		
220	6.3x11 240	6.3x11 265	6.3x11 295	8x11.5 380	10x12.5 500	10x16 590	10x20 690	13x25 880	18x35.5 1050	18x40 1100	22x40 1209			
330	6.3x11 300	8x11.5 385	8x11.5 420	10x12.5 550	10x16 670	10x20 780	13x20 990	16x25 1200	22x40 1480	22x40 1480				
470	8x11.5 420	8x11.5 460	10x12.5 600	10x16 720	10x20 870	13x20 1100	13x25 1290	16x31.5 1570						
680	8x11.5 500	10x12.5 640	10x16 860	10x20 790	13x20 1230	13x25 1440	16x25 1730	18x35.5 2130						
1,000	10x12.5 710	10x16 850	10x16 1040	13x20 1340	13x25 1630	16x25 1940	16x31.5 2290	22x40 2980						
1,500	10x20 990	13x20 1260	13x20 1380	13x25 1630	16x25 1980	16x35.5 2400	18x35.5 2730							
2,200	10x20 1240	13x20 1440	13x25 1710	16x25 2030	16x31.5 2400	18x35.5 2820	22x40 3420							
3,300	13x20 1570	13x25 1830	16x25 2190	16x31.5 2540	18x35.5 3060	22x40 3670								
4,700	13x25 1990	16x25 2320	16x31.5 2720	18x35.5 3220	22x40 3950									
6,800	16x25 2440	16x31.5 2810	18x35.5 3360	18x40 3690	← 外壳尺寸 Case Size ØD x L(mm) ← 纹波电流 Ripple Current (mA rms) 在 85°C, 120Hz									
10,000	16x31.5 2950	18x35.5 3480	18x40 3760											
15,000	18x35.5 3600	22x40 4300												
22,000	22x40 4420													

鋁電解電容器

Aluminum Electrolytic Capacitor

MKR 系列

标准系列, 普通用途. Standard Series, General Use.

- 105°C, 耐久性 3,000 小时.
(Ø5, Ø6.3 为 1,000 小时, Ø8 为 2,000 小时)
105°C, Load Life: 3,000 Hours.
(Ø5, Ø6.3: 1,000 Hours, Ø8: 2,000 Hours)



项目 Item	特性 Specifications																						
额定工作电压 Rated Working Voltage	6.3 ~ 450 V																						
工作温度范围 Temperature Range	-40 ~ +105°C (6.3 ~ 350V), -25 ~ +105°C (400 ~ 450V)																						
容量允许误差 Capacitance Tolerance	± 20% (在 20°C, 120 Hz)																						
最大泄漏电流 Leakage Current (在 20°C)	<table border="1"> <thead> <tr> <th>额定电压 Rated Voltage</th> <th colspan="2">≤ 100V</th> <th colspan="2">> 100V</th> </tr> <tr> <th>充电时间 Charge Time</th> <td>1 分钟 1 minute</td> <td>2 分钟 2 minute</td> <td colspan="2">1 分钟 1 minute</td> </tr> <tr> <th>泄漏电流 Leakage Current</th> <td>0.03CV 或 4µA 取较大值 0.03CV or 4µA whichever is greater</td> <td>0.01CV 或 3µA 取较大值 0.01CV or 3µA whichever is greater</td> <td>CV ≤ 1000</td> <td>CV > 1000</td> </tr> <tr> <td></td> <td></td> <td></td> <td>0.1CV + 40 (µA)</td> <td>0.04CV + 100 (µA)</td> </tr> </thead> </table>	额定电压 Rated Voltage	≤ 100V		> 100V		充电时间 Charge Time	1 分钟 1 minute	2 分钟 2 minute	1 分钟 1 minute		泄漏电流 Leakage Current	0.03CV 或 4µA 取较大值 0.03CV or 4µA whichever is greater	0.01CV 或 3µA 取较大值 0.01CV or 3µA whichever is greater	CV ≤ 1000	CV > 1000				0.1CV + 40 (µA)	0.04CV + 100 (µA)		
	额定电压 Rated Voltage	≤ 100V		> 100V																			
	充电时间 Charge Time	1 分钟 1 minute	2 分钟 2 minute	1 分钟 1 minute																			
泄漏电流 Leakage Current	0.03CV 或 4µA 取较大值 0.03CV or 4µA whichever is greater	0.01CV 或 3µA 取较大值 0.01CV or 3µA whichever is greater	CV ≤ 1000	CV > 1000																			
			0.1CV + 40 (µA)	0.04CV + 100 (µA)																			
最大损失角正切 Dissipation Factor	<table border="1"> <thead> <tr> <th>额定电压 (V) Rated Voltage</th> <th>6.3</th> <th>10</th> <th>16</th> <th>25</th> <th>35</th> <th>50</th> <th>63</th> <th>100</th> <th>160~250</th> <th>350~450</th> </tr> </thead> <tbody> <tr> <td>损失角 (tan δ) D.F.</td> <td>0.24</td> <td>0.20</td> <td>0.16</td> <td>0.14</td> <td>0.12</td> <td>0.10</td> <td>0.09</td> <td>0.08</td> <td>0.15</td> <td>0.20</td> </tr> </tbody> </table>	额定电压 (V) Rated Voltage	6.3	10	16	25	35	50	63	100	160~250	350~450	损失角 (tan δ) D.F.	0.24	0.20	0.16	0.14	0.12	0.10	0.09	0.08	0.15	0.20
	额定电压 (V) Rated Voltage	6.3	10	16	25	35	50	63	100	160~250	350~450												
损失角 (tan δ) D.F.	0.24	0.20	0.16	0.14	0.12	0.10	0.09	0.08	0.15	0.20													
注: 电容器容量超过 1,000µF 后, 每增加 1,000µF, 损失角 (tan δ) 增加 0.02. (在 20°C, 120 Hz) Note: For capacitance of more than 1,000µF, the value of D.F. should be added 0.02 for every increase of 1,000µF.																							
耐久性 Load Life	电容器在 105°C 环境中施加额定电压连续 3,000 小时 (Ø5, Ø6.3 为 1,000 小时, Ø8 为 2,000 小时) 后, 冷却至 20°C 测量, 特性应满足: The following specifications shall be satisfied when the capacitors are restored to 20°C after the rated voltage is applied for 3,000 hours at 105°C (Ø5, Ø6.3: 1,000 hours, Ø8: 2,000hours)		容量变化 Capacitance Change		± 20% 以内 ≤ ± 20% of the initial value																		
			损失角 (tan δ) D.F.		小于初始规定值的 200% ≤ 200% of the initial specified value																		
		泄漏电流 Leakage Current		小于初始规定值 ≤ the initial specified value																			
其它 Others	满足 JIS C5141 之 W 项规定 Satisfies characteristic W of JIS C5141																						

图形和尺寸 Figure and Dimensions

单位 Unit: mm

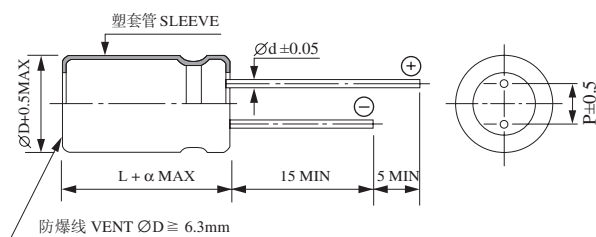

ØD	5	6.3	8	10	13	16	18	22
Ød	0.5	0.5	0.6	0.6	0.6	0.8	0.8	1.0
P	2.0	2.5	3.5	5.0	5.0	7.5	7.5	10.0
α	1.5				2.0			

纹波电流频率系数

Frequency Multiplying Factor of Ripple Current

V	Hz					
	µF	50	120	300	1K	10K
6.3 ~ 100	~ 68	0.75	1.00	1.35	1.57	2.00
	100 ~ 680	0.80	1.00	1.23	1.34	1.50
	1000 ~ 15000	0.85	1.00	1.10	1.13	1.15
160 ~ 450	0.68 ~ 220	0.80	1.00	1.25	1.40	1.60
	330 ~	0.90	1.00	1.10	1.13	1.15

鋁電解電容器

Aluminum Electrolytic Capacitor

MKR 系列

外壳尺寸和最大纹波电流 Case Size and Rated Ripple Current

V μF	6.3	10	16	25	35	50	63	100	160	200	250	350	400	450
0.1						5x11 5.0		5x11 5.5						
0.15						5x11 6.2		5x11 6.7						
0.22						5x11 7.5		5x11 8.2						
0.33						5x11 9.2		5x11 10						
0.47						5x11 11		5x11 12						
0.68						5x11 13		5x11 15	6.3x11 13	6.3x11 13	6.3x11 13			
1.0						5x11 16		5x11 18	6.3x11 16	6.3x11 16	6.3x11 16	8x11.5 19	8x11.5 19	8x11.5 16
1.5						5x11 20		5x11 22	6.3x11 19	6.3x11 19	8x11.5 23	10x12.5 27	10x12.5 27	10x12.5 22
2.2						5x11 24		5x11 26	6.3x11 23	6.3x11 23	8x11.5 28	10x12.5 32	10x12.5 32	10x12.5 27
3.3						5x11 29		5x11 32	8x11.5 34	8x11.5 34	10x12.5 39	10x16 43	10x16 43	10x16 36
4.7				5x11 28	5x11 30	5x11 35	5x11 38	5x11 38	8x11.5 40	10x12.5 47	10x12.5 47	10x16 51	10x16 51	10x20 47
6.8				5x11 34	5x11 36	5x11 42	5x11 46	6.3x11 53	10x12.5 56	10x16 62	10x16 62	10x16 67	10x20 67	13x20 66
10			5x11 37	5x11 41	5x11 44	5x11 51	5x11 56	6.3x11 64	10x16 75	10x16 75	10x16 75	10x20 82	13x20 96	13x20 80
15			5x11 45	5x11 50	5x11 54	5x11 61	6.3x11 78	8x11.5 93	10x16 92	10x20 100	10x20 100	13x20 118	13x25 128	13x25 107
22		5x11 51	5x11 55	5x11 61	5x11 65	5x11 75	6.3x11 95	8x11.5 110	10x20 121	10x20 121	13x20 140	13x25 155	13x25 155	16x25 144
33	5x11 56	5x11 62	5x11 67	5x11 75	5x11 80	6.3x11 106	6.3x11 116	10x12.5 160	13x20 175	13x20 175	13x20 175	16x25 210	16x25 210	16x31.5 190
47	5x11 67	5x11 74	5x11 81	5x11 90	6.3x11 110	6.3x11 127	8x11.5 160	10x16 210	13x20 210	13x25 230	13x25 230	16x31.5 270	16x35.5 290	18x40 270
68	5x11 82	5x11 90	5x11 98	6.3x11 125	6.3x11 130	8x11.5 180	8x11.5 190	10x20 270	13x25 270	16x25 303	16x25 303	16x35.5 350	18x40 390	
100	5x11 99	5x11 109	6.3x11 137	6.3x11 150	8x11.5 190	8x11.5 220	10x12.5 280	13x20 390	16x25 370	16x31.5 400	16x35.5 420	18x40 480		
150	6.3x11 140	6.3x11 154	6.3x11 167	8x11.5 220	10x12.5 260	10x16 340	10x20 410	13x25 520	16x31.5 490	18x35.5 550	18x40 580			
220	6.3x11 168	6.3x11 186	8x11.5 240	8x11.5 260	10x12.5 320	10x16 410	10x20 490	16x25 700	18x35.5 660	18x40 700				
330	6.3x11 206	8x11.5 270	8x11.5 290	10x12.5 370	10x16 440	10x20 550	13x20 710	16x31.5 950	18x40 860					
470	8x11.5 290	8x11.5 320	10x12.5 400	10x16 490	10x20 570	13x20 770	13x25 920	18x35.5 1250						
680	8x11.5 349	10x12.5 440	10x16 530	10x20 650	13x20 800	13x25 1010	16x25 1230	18x40 1590						
1,000	10x12.5 490	10x16 590	10x20 700	13x20 920	13x25 1060	16x25 1360	16x31.5 1630							
1,500	10x20 680	10x20 740	13x20 940	13x25 1110	16x25 1290	16x31.5 1580	18x40 1990							
2,200	13x20 910	13x20 990	13x20 1150	16x25 1370	16x31.5 1560	18x35.5 1920								
3,300	13x20 1070	13x25 1250	16x25 1470	16x31.5 1710	18x35.5 1990									
4,700	16x25 1470	16x25 1570	16x31.5 1810	18x35.5 2160										
6,800	16x25 1640	16x31.5 1900	18x35.5 2290											
10,000	16x31.5 1980	18x35.5 2330												
15,000	18x35.5 2400													

← 外壳尺寸 Case Size ØD x L(mm)
 ← 纹波电流 Ripple Current (mA rms) 在 105°C, 120Hz

鋁電解電容器

Aluminum Electrolytic Capacitor

SR 系列

- 高 CV 值, 比 MSR 系列尺寸更小。
High CV, Smaller Size than MSR Series
- 85°C, 耐久性 3,000 小时。
($\varnothing 5$, $\varnothing 6.3$ 为 1,000 小时, $\varnothing 8$ 为 2,000 小时)
85°C, Load Life: 3,000 Hours.
($\varnothing 5$, $\varnothing 6.3$: 1,000 Hours, $\varnothing 8$: 2,000 Hours)



项目	特性																						
额定工作电压 Rated Voltage Range	6.3 ~ 450 VDC																						
工作温度范围 Temperature Range	-40 ~ +85°C (6.3 ~ 350V), -25 ~ +85°C (400 ~ 450V)																						
容量允许误差 Capacitance Tolerance	± 20% (在 20°C, 120 Hz)																						
最大泄漏电流 Leakage Current (在 20°C)	<table border="1"> <thead> <tr> <th>额定电压 Rated Voltage</th> <th colspan="2">≤ 100V</th> <th colspan="2">> 100V</th> </tr> <tr> <th>时间 Charge Time</th> <th>1 分钟 1 minute</th> <th>2 分钟 2 minute</th> <th colspan="2">1 分钟 1 minute</th> </tr> <tr> <th>泄漏电流 Leakage Current</th> <td>0.03CV 或 4µA 取较大值 0.03CV or 4µA whichever is greater</td> <td>0.01CV 或 3µA 取较大值 0.01CV or 3µA whichever is greater</td> <td>CV ≤ 1000</td> <td colspan="2">CV > 1000</td> </tr> <tr> <td></td> <td></td> <td></td> <td>0.1CV + 40 (µA)</td> <td colspan="2">0.04CV + 100 (µA)</td> </tr> </thead> </table>	额定电压 Rated Voltage	≤ 100V		> 100V		时间 Charge Time	1 分钟 1 minute	2 分钟 2 minute	1 分钟 1 minute		泄漏电流 Leakage Current	0.03CV 或 4µA 取较大值 0.03CV or 4µA whichever is greater	0.01CV 或 3µA 取较大值 0.01CV or 3µA whichever is greater	CV ≤ 1000	CV > 1000					0.1CV + 40 (µA)	0.04CV + 100 (µA)	
	额定电压 Rated Voltage	≤ 100V		> 100V																			
	时间 Charge Time	1 分钟 1 minute	2 分钟 2 minute	1 分钟 1 minute																			
泄漏电流 Leakage Current	0.03CV 或 4µA 取较大值 0.03CV or 4µA whichever is greater	0.01CV 或 3µA 取较大值 0.01CV or 3µA whichever is greater	CV ≤ 1000	CV > 1000																			
			0.1CV + 40 (µA)	0.04CV + 100 (µA)																			
最大损失角正切 Dissipation Factor	<table border="1"> <thead> <tr> <th>额定电压 (V) Rated Voltage</th> <th>6.3</th> <th>10</th> <th>16</th> <th>25</th> <th>35</th> <th>50</th> <th>63</th> <th>100</th> <th>160~250</th> <th>350~450</th> </tr> </thead> <tbody> <tr> <td>损失角 (tan δ) D.F</td> <td>0.28</td> <td>0.24</td> <td>0.20</td> <td>0.16</td> <td>0.14</td> <td>0.12</td> <td>0.10</td> <td>0.08</td> <td>0.20</td> <td>0.25</td> </tr> </tbody> </table>	额定电压 (V) Rated Voltage	6.3	10	16	25	35	50	63	100	160~250	350~450	损失角 (tan δ) D.F	0.28	0.24	0.20	0.16	0.14	0.12	0.10	0.08	0.20	0.25
	额定电压 (V) Rated Voltage	6.3	10	16	25	35	50	63	100	160~250	350~450												
损失角 (tan δ) D.F	0.28	0.24	0.20	0.16	0.14	0.12	0.10	0.08	0.20	0.25													
注: 电容器容量超过 1,000µF 后, 每增加 1,000µF, 损失角 (tan δ) 增加 0.02。 (在 20°C, 120 Hz) Note: For capacitance of more than 1,000µF, the value of D.F should be added 0.02 for every increase of 1,000µF.																							
耐久性 Load Life	电容器在 85°C 环境中施加额定电压连续 3,000 小时 ($\varnothing 5$, $\varnothing 6.3$ 为 1,000 小时, $\varnothing 8$ 以下为 2,000 小时) 后, 冷却至 20°C 测量, 特性应满足: The following specifications shall be satisfied when the capacitors are restored to 20°C after the rated voltage is applied for 3,000 hours at 85°C ($\varnothing 5$, $\varnothing 6.3$: 1,000 hours, $\varnothing 8$: 2,000 hours)		容量变化 Capacitance Change		± 20% 以内 ≤ ± 20% of the initial value																		
			损失角 (tan δ) D.F		小于初始规定值的 200% ≤ 200% of the initial specified value																		
			泄漏电流 Leakage Current		小于初始规定值 ≤ the initial specified value																		
其它 Others	满足 JIS C5141 之 W 项规定. Satisfies characteristic W of JIS C5141																						

图形和尺寸 Figure and Dimensions

单位 Unit: mm

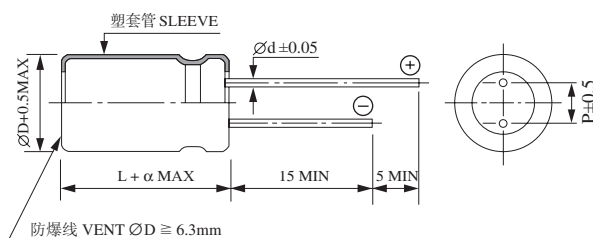

ØD	5	6.3	8	10	13	16	18	22
Ød	0.5	0.5	0.6	0.6	0.6	0.8	0.8	1.0
P	2.0	2.5	3.5	5.0	5.0	7.5	7.5	10.0
α	1.5						2.0	

纹波电流频率系数

Frequency Multiplying Factor of Ripple Current

V	Hz					
	µF	50	120	300	1K	10K
6.3 ~ 100	~ 68	0.75	1.00	1.35	1.57	2.00
	100 ~ 680	0.80	1.00	1.23	1.34	1.50
	1000 ~ 15000	0.85	1.00	1.10	1.13	1.15
160 ~ 450	0.68 ~ 220	0.80	1.00	1.25	1.40	1.60
	330 ~	0.90	1.00	1.10	1.13	1.15

鋁電解電容器

Aluminum Electrolytic Capacitor

SR 系列

外壳尺寸和最大纹波电流 Case Size and Rated Ripple Current

V μF	6.3	10	16	25	35	50	63	100	160	200	250	350	400	450
1.0												6.3x11 20	6.3x11 20	8x11.5 22
2.2											6.3x11 32	6.3x11 30	8x11.5 38	8x11.5 28
3.3									6.3x11 40	6.3x11 40	6.3x11 40	8x11.5 43	8x11.5 43	10x12.5 40
4.7									6.3x11 50.	6.3x11 50	8x11.5 57	8x11.5 55	10x12.5 60	10x12.5 46
6.8								5x11 57	8x11.5 65	8x11.5 65	8x11.5 65	10x12.5 74	10x16 83	10x16 60
10								5x11 70	8x11.5 80	8x11.5 80	10x12.5 100	10x12.5 90	10x16 100	10x20 80
22							5x11 100	6.3x11 130	10x12.5 130	10x16 150	10x20 160	13x20 150	13x25 200	13x2.5 140
33						5x11 125	6.3x11 140	8x11.5 180	10x16 180	10x20 200	10x20 200	13x25 240	16x25 240	16x25 180
47					5x11 128	6.3x11 155	6x11 170	8x11.5 200	10x20 210	13x20 270	13x20 270	16x25 300	16x25 280	16x31.5 220
68					6.3x11 175	6.3x11 210	8x11.5 220	10x12.5 270	13x20 350	13x25 350	16x25 380	16x25 400	16x31.5 340	18x35.5 260
100			5x11 160	5x11 180	6.3x11 210	8x11.5 260	8x11.5 280	10x16 340	13x25 430	16x25 440	16x25 440	18x35.5 520	18x35.5 440	18x40 280
220		5x11 220	6.3x11 260	6.3x11 280	8x11.5 350	10x12.5 430	10x16 490	13x20 550	16x31.5 580	16x35.5 700	18x35.5 680	22x42 940		
330		6.3x11 290	6.3x11 320	8x11.5 390	10x12.5 490	10x16 590	10x20 710	13x25 760	18x35.5 800	18x40 950	22x42 1110			
470		6.3x11 350	8x11.5 440	10x12.5 550	10x16 650	10x20 760	13x20 900	16x25 1000	18x40 1200	22x42 1330				
680		8x11.5 470	10x12.5 570	10x16 710	10x20 860	13x20 1000	13x25 1140	16x31.5 1360						
1,000	8x11.5 540	10x12.5 650	10x12.5 700	10x16 860	13x20 1150	13x25 1350	16x25 1300	18x35.5 1850						
2,200	10x16 890	10x16 990	10x20 1000	13x25 1550	16x25 1800	16x31.5 1980	18x35.5 2300							
3,300	10x20 1190	13x20 1450	13x25 1700	16x25 1980	16x31.5 2100	18x35.5 2500	22x42 2700							
4,700	13x20 1550	13x25 1800	16x25 2100	16x25 2200	16x35.5 2500	22x42 2900								
6,800	13x25 1920	16x25 2250	16x25 2250	16x35.5 2600	18x40 2800	← 外壳尺寸 Case Size ØD x L(mm) ← 纹波电流 Ripple Current (mA rms) 在 85°C, 120Hz								
10,000	16x25 2350	16x31.5 2550	16x35.5 2710	18x40 2800										
15,000	16x31.5 2550	16x35.5 2880	18x40 3100											
22,000	18x35.5 3200	18x40 3400	22x42 3800											
33,000	22x42 3500													

鋁電解電容器

Aluminum Electrolytic Capacitor

SK 系列

- 高 CV 值, 比 MSR 系列尺寸更小.
High CV, Smaller Size than MSR Series
- 105°C, 耐久性 2,000 小时.
(Ø8 及以下为 1,000 小时).
105°C, Load Life: 2,000 Hours.
(Ø8 and below: 1,000 Hours).



项目	特性																						
额定工作电压 Rated Voltage Range	6.3 ~ 450 VDC																						
工作温度范围 Temperature Range	-40 ~ +105°C (6.3 ~ 350V), -25 ~ +105°C (400 ~ 450V)																						
容量允许误差 Capacitance Tolerance	± 20% (在 20°C, 120 Hz)																						
最大泄漏电流 Leakage Current (在 20°C)	<table border="1"> <thead> <tr> <th>额定电压 Rated Voltage</th> <th colspan="2">≤ 100V</th> <th colspan="2">> 100V</th> </tr> <tr> <th>时间 Charge Time</th> <th>1 分钟</th> <th>2 分钟</th> <th colspan="2">1 分钟</th> </tr> </thead> <tbody> <tr> <td>泄漏电流 Leakage Current</td> <td>0.03CV 或 4μA 取较大值 0.03CV or 4μA whichever is greater</td> <td>0.01CV 或 3μA 取较大值 0.01CV or 3μA whichever is greater</td> <td>CV ≤ 1000</td> <td colspan="2">CV > 1000</td> </tr> <tr> <td></td> <td></td> <td></td> <td>0.1CV + 40 (μA)</td> <td colspan="2">0.04CV + 100 (μA)</td> </tr> </tbody> </table>	额定电压 Rated Voltage	≤ 100V		> 100V		时间 Charge Time	1 分钟	2 分钟	1 分钟		泄漏电流 Leakage Current	0.03CV 或 4μA 取较大值 0.03CV or 4μA whichever is greater	0.01CV 或 3μA 取较大值 0.01CV or 3μA whichever is greater	CV ≤ 1000	CV > 1000					0.1CV + 40 (μA)	0.04CV + 100 (μA)	
	额定电压 Rated Voltage	≤ 100V		> 100V																			
	时间 Charge Time	1 分钟	2 分钟	1 分钟																			
泄漏电流 Leakage Current	0.03CV 或 4μA 取较大值 0.03CV or 4μA whichever is greater	0.01CV 或 3μA 取较大值 0.01CV or 3μA whichever is greater	CV ≤ 1000	CV > 1000																			
			0.1CV + 40 (μA)	0.04CV + 100 (μA)																			
最大损失角正切 Dissipation Factor	<table border="1"> <thead> <tr> <th>额定电压 (V) Rated Voltage</th> <th>6.3</th> <th>10</th> <th>16</th> <th>25</th> <th>35</th> <th>50</th> <th>63</th> <th>100</th> <th>160~250</th> <th>350~450</th> </tr> </thead> <tbody> <tr> <td>损失角 (tan δ) D.F</td> <td>0.28</td> <td>0.24</td> <td>0.20</td> <td>0.16</td> <td>0.14</td> <td>0.12</td> <td>0.10</td> <td>0.08</td> <td>0.20</td> <td>0.25</td> </tr> </tbody> </table>	额定电压 (V) Rated Voltage	6.3	10	16	25	35	50	63	100	160~250	350~450	损失角 (tan δ) D.F	0.28	0.24	0.20	0.16	0.14	0.12	0.10	0.08	0.20	0.25
	额定电压 (V) Rated Voltage	6.3	10	16	25	35	50	63	100	160~250	350~450												
损失角 (tan δ) D.F	0.28	0.24	0.20	0.16	0.14	0.12	0.10	0.08	0.20	0.25													
注: 电容器容量超过 1,000μF 后, 每增加 1,000μF, 损失角 (tan δ) 增加 0.02. (在 20°C, 120 Hz) Note: For capacitance of more than 1,000μF, the value of D.F should be added 0.02 for every increase of 1,000μF.																							
耐久性 Load Life	电容器在 105°C 环境中施加额定电压连续 2,000 小时 (Ø8 及以下为 1,000 小时) 后, 冷却至 20°C 测量, 特性应满足: The following specifications shall be satisfied when the capacitors are restored to 20°C after the rated voltage is applied for 2,000 hours at 105°C (Ø8 and below: 1,000hours)		容量变化 Capacitance Change		± 20% 以内 ≤ ± 20% of the initial value																		
			损失角 (tan δ) D.F		小于初始规定值的 200% ≤ 200% of the initial specified value																		
		泄漏电流 Leakage Current		小于初始规定值 ≤ the initial specified value																			
其它 Others	满足 JIS C5141 之 W 项规定. Satisfies characteristic W of JIS C5141																						

图形和尺寸 Figure and Dimensions

单位 Unit: mm

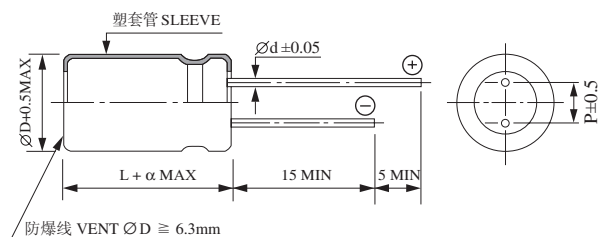

ØD	5	6.3	8	10	13	16	18	22
Ød	0.5	0.5	0.6	0.6	0.6	0.8	0.8	1.0
P	2.0	2.5	3.5	5.0	5.0	7.5	7.5	10.0
α	1.5					2.0		

纹波电流频率系数

Frequency Multiplying Factor of Ripple Current

V	Hz					
	μF	50	120	300	1K	10K
6.3 ~ 100	~ 68	0.75	1.00	1.35	1.57	2.00
	100 ~ 680	0.80	1.00	1.23	1.34	1.50
	1000 ~ 15000	0.85	1.00	1.10	1.13	1.15
160 ~ 450	0.68 ~ 220	0.80	1.00	1.25	1.40	1.60
	330 ~	0.90	1.00	1.10	1.13	1.15

鋁電解電容器

Aluminum Electrolytic Capacitor

SK 系列

外壳尺寸和最大纹波电流 Case Size and Rated Ripple Current

V μF	6.3	10	16	25	35	50	63	100	160	200	250	350	400	450
1.0												6.3x11 14	6.3x11 14	8x11.5 16
2.2											6.3x11 23	6.3x11 21	8x11.5 27	8x11.5 20
3.3									6.3x11 28	6.3x11 28	6.3x11 28	8x11.5 30	8x11.5 34	10x12.5 28
4.7									6.3x11 36	6.3x11 36	8x11.5 41	8x11.5 39	10x12.5 42	10x12.5 32
6.8								5x11 41	8x11.5 46	8x11.5 46	8x11.5 46	10x12.5 53	10x16 59	10x16 43
10								5x11 50	8x11.5 57	8x11.5 57	10x12.5 71	10x12.5 64	10x16 64	10x20 57
22							5x11 71	6.3x11 93	10x12.5 92	10x16 105	10x20 105	13x20 105	13x25 140	13x2.5 100
33						5x11 90	6.3x11 100	8x11.5 130	10x16 125	10x20 140	10x20 140	13x25 170	16x25 170	16x25 128
47					5x11 93	6.3x11 115	6x11 120	8x11.5 140	10x20 150	13x20 195	13x20 190	16x25 210	16x25 200	16x31.5 157
68					6.3x11 110	6.3x11 150	8x11.5 155	10x12.5 190	13x20 250	13x25 250	16x25 270	16x25 280	16x31.5 240	18x35.5 186
100			5x11 110	5x11 125	6.3x11 150	8x11.5 190	8x11.5 200	10x16 240	13x25 310	16x25 320	16x25 310	18x35.5 370	18x35.5 310	18x40 200
220		5x11 155	6.3x11 190	6.3x11 200	8x11.5 250	10x12.5 300	10x16 335	13x20 390	16x31.5 410	16x35.5 500	18x35.5 480	22x42 670		
330		6.3x11 210	6.3x11 225	8x11.5 275	10x12.5 350	10x16 410	10x20 510	13x25 540	18x35.5 570	18x40 670	22x42 710			
470		6.3x11 250	8x11.5 315	10x12.5 380	10x16 460	10x20 540	13x20 640	16x25 715	18x40 850	22x42 920				
680		8x11.5 330	10x12.5 410	10x16 510	10x20 610	13x20 710	13x25 810	16x31.5 970						
1,000	8x11.5 390	10x12.5 460	10x12.5 500	10x16 610	13x20 810	13x25 950	16x25 930	18x35.5 960						
2,200	10x16 635	10x16 710	10x20 710	13x25 1090	16x25 1260	16x31.5 1410	18x35.5 1650							
3,300	10x20 840	13x20 1000	13x25 1170	16x25 1400	16x31.5 1500	18x35.5 1770	22x42 1950							
4,700	13x20 1090	13x25 1260	16x25 1500	16x25 1570	16x35.5 1780	22x42 2100								
6,800	13x25 1350	16x25 1570	16x25 1600	16x35.5 1850	18x40 2000	← 外壳尺寸 Case Size ØD x L(mm) ← 纹波电流 Ripple Current (mA rms) 在 105°C, 120Hz								
10,000	16x25 1650	16x31.5 1820	16x35.5 1930	18x40 2000										
15,000	16x31.5 1820	16x35.5 2050	18x40 2210											
22,000	18x35.5 2280	18x40 2420	22x42 2710											
33,000	22x42 2500													

鋁電解電容器

Aluminum Electrolytic Capacitor

LL 系列

- 低漏電產品. Low Leakage Current
- 85°C, 耐久性 5,000 小時.
(Ø5, Ø6.3 為 3,000 小時, Ø8 為 4,000 小時)
85°C, Load Life 5,000 Hours.
(Ø5, Ø6.3: 3,000 Hour, Ø8: 4,000 Hour)
- 具有優良的儲存性. Excellent Shelf Life



項目 Item	特性 Specifications																		
額定工作電壓 Rated Voltage Range	6.3 ~ 100 VDC																		
工作溫度範圍 Temperatur Range	-40 ~ +85°C																		
容量允許誤差 Capacitance Tolerance	± 20% (在 20°C, 120 Hz)																		
最大洩漏電流 Leakage Current	施加額定電壓 1 分鐘後, 漏電流不超過 0.002CV 或 0.2µA, 取較大值。 (在 20°C) After 1 minute, 0.002CV or 0.2µA, whichever is greater. (at 20°C)																		
最大損失角正切 Dissipation Factor	<table border="1"> <thead> <tr> <th>額定電壓 (V) Rated Voltage</th> <th>6.3</th> <th>10</th> <th>16</th> <th>25</th> <th>35</th> <th>50</th> <th>63</th> <th>100</th> </tr> </thead> <tbody> <tr> <td>損失角 (tan δ) D.F</td> <td>0.21</td> <td>0.17</td> <td>0.14</td> <td>0.12</td> <td>0.11</td> <td>0.10</td> <td>0.09</td> <td>0.08</td> </tr> </tbody> </table> <p>(在 20°C, 120 Hz)</p> <p>注: 電容器容量超過 1,000µF 後, 每增加 1,000µF, 損失角 (tan δ) 增加 0.02. Note: For capacitance of more than 1,000µF, the value of D.F should be added 0.02 for every increase of 1,000µF.</p>	額定電壓 (V) Rated Voltage	6.3	10	16	25	35	50	63	100	損失角 (tan δ) D.F	0.21	0.17	0.14	0.12	0.11	0.10	0.09	0.08
額定電壓 (V) Rated Voltage	6.3	10	16	25	35	50	63	100											
損失角 (tan δ) D.F	0.21	0.17	0.14	0.12	0.11	0.10	0.09	0.08											
耐久性 Laod Life	<p>電容器在 85°C 環境中施加額定電壓連續 5,000 小時 (Ø5, Ø6.3 為 3,000 小時, Ø8 為 4,000 小時) 後, 冷卻至 20°C 測量, 特性應滿足:</p> <p>The following specifications shall be satisfied when the capacitors are restored to 20°C after the rated voltage is applied for 5,000 hours at 85°C (Ø5, Ø6.3: 3,000 hours, Ø8: 4,000 hours)</p> <table border="1"> <tbody> <tr> <td>容量變化 Capacitance Change</td> <td>± 20% 以內 ≤ ± 20% of the initial value</td> </tr> <tr> <td>損失角 (tan δ) D.F</td> <td>小於初始規定值的 200% ≤ 200% of the initial specified value</td> </tr> <tr> <td>洩漏電流 Leakage Current</td> <td>小於初始規定值 ≤ the initial specified value</td> </tr> </tbody> </table>	容量變化 Capacitance Change	± 20% 以內 ≤ ± 20% of the initial value	損失角 (tan δ) D.F	小於初始規定值的 200% ≤ 200% of the initial specified value	洩漏電流 Leakage Current	小於初始規定值 ≤ the initial specified value												
容量變化 Capacitance Change	± 20% 以內 ≤ ± 20% of the initial value																		
損失角 (tan δ) D.F	小於初始規定值的 200% ≤ 200% of the initial specified value																		
洩漏電流 Leakage Current	小於初始規定值 ≤ the initial specified value																		
儲存性 Shelf Life	未加電壓的電容器在 85°C 環境中儲存 1000 小時後, 冷卻至 20°C 測量, 特性應滿足耐久性規定。 When the capacitors are restored to 20°C after exposing them at 85°C for 1,000 hours without voltage applied, the specifications shall satisfy the specifications of the load life.																		
其它 Others	滿足 JIS C5141 之 W 項規定 Satisfies characteristic W of JIS C5141																		

圖形和尺寸 Figure and Dimensions

單位 Unit: mm

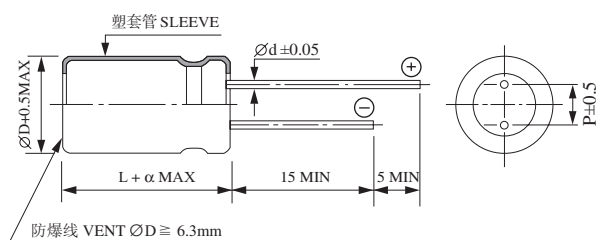

ØD	5	6.3	8	10	13	16	18
Ød	0.5	0.5	0.6	0.6	0.6	0.8	0.8
P	2.0	2.5	3.5	5.0	5.0	7.5	7.5
α	1.5					2.0	

紋波電流頻率係數

Frequency Multiplying Factor of Ripple Current

µF	Hz				
	50	120	300	1K	10K
~ 68	0.75	1.00	1.35	1.57	2.00
100 ~ 680	0.80	1.00	1.23	1.34	1.50
1000 ~ 10000	0.85	1.00	1.10	1.13	1.15

鋁電解電容器

Aluminum Electrolytic Capacitor

LL 系列

外壳尺寸和最大纹波电流 Case Size and Rated Ripple Current

μF \ V	6.3		10		16		25		35		50		63		100	
	0.1											5×11	1.1			5×11
0.15											5×11	1.6			5×11	3.2
0.22											5×11	2.3			5×11	4.7
0.33											5×11	3.5			5×11	7.0
0.47											5×11	5.0			5×11	10.1
0.68											5×11	7.3			5×11	14.5
1.0											5×11	10.7			5×11	19
1.5											5×11	16			5×11	23
2.2											5×11	23			5×11	28
3.3											5×11	40			5×11	45
4.7							5×11	41	5×11	43	5×11	45			5×11	50
6.8							5×11	50	5×11	52	5×11	55	5×11	59	6.3×11	65
10					5×11	59	5×11	64	5×11	67	5×11	70	6.3×11	75	8×11.5	90
15					5×11	70	5×11	81	5×11	85	6.3×11	95	6.3×11	100	8×11.5	110
22					5×11	85	5×11	100	6.3×11	104	6.3×11	110	8×11.5	115	10×12.5	136
33					5×11	100	6.3×11	140	6.3×11	150	8×11.5	165	8×11.5	170	10×16	180
47			5×11	110	6.3×11	140	6.3×11	170	8×11.5	190	8×11.5	190	10×12.5	200	10×20	220
68			6.3×11	150	6.3×11	160	8×11.5	230	8×11.5	230	10×12.5	250	10×16	270	10×20	290
100			6.3×11	180	8×11.5	230	8×11.5	280	10×12.5	300	10×16	320	10×20	330	13×20	370
150			8×11.5	250	8×11.5	280	10×12.5	370	10×16	400	10×20	420	13×20	450	13×25	470
220			8×11.5	310	10×12.5	370	10×16	400	10×20	440	13×20	490	13×20	550	16×25	580
330			10×12.5	400	10×16	420	10×20	490	13×20	550	13×20	600	13×25	710	16×31.5	730
470	10×12.5	390	10×16	530	10×20	550	13×20	660	13×25	680	16×25	760	16×25	850	18×35.5	910
680	10×16	480	10×20	600	13×20	730	13×25	810	16×25	840	16×25	910	16×31.5	1050		
1,000	10×20	650	13×20	810	13×25	910	16×25	1010	16×31.5	1110	16×31.5	1140	18×35.5	1330		
1,500	13×20	830	13×25	1020	16×25	1150	16×31.5	1270	16×35.5	1390	18×40	1480				
2,200	13×25	1060	16×25	1200	16×31.5	1430	16×35.5	1440	18×35.5	1580						
3,300	16×25	1270	16×31.5	1420	16×35.5	1550	18×40	1720								
4,700	16×31.5	1500	16×35.5	1650	18×35.5	1820										
6,800	18×35.5	1760	18×35.5	1890												
10,000	18×40	1900														

纹波电流 R.C (mA rms) 在 85°C, 120Hz
 外壳尺寸 Case Size ØDxL (mm)

鋁電解電容器

Aluminum Electrolytic Capacitor

MBP 系列

双极性, 标准系列. Bi-polar, Standard Series.

- 85°C, 耐久性 3,000 小时.
($\varnothing 5, \varnothing 6.3$ 为 1,000 小时, $\varnothing 8$ 为 2,000 小时)
85°C, Load Life: 3,000 Hours.
($\varnothing 5, \varnothing 6.3$: 1,000Hours, $\varnothing 8$: 2,000Hours)
- 适用于未知极性 or 极性翻转电路。
Used for Polarity Change or Reverse Circuit.



项目 Item	特性 Specifications																																									
额定工作电压 Rated Voltage Range	6.3 ~ 250 VDC																																									
工作温度范围 Temperature Range	-40 ~ +85°C																																									
容量允许误差 Capacitance Tolerance	± 20% (M) ± 10% (K) (在 20°C, 120 Hz)																																									
最大泄漏电流 Leakage Current (双向 in both polarity) (在 20°C)	<table border="1"> <tr> <td>额定电压 Rated Voltage</td> <td colspan="2">≤ 100V</td> <td colspan="2">> 100V</td> </tr> <tr> <td>时间 Charge Time</td> <td>1 分钟 1 minute</td> <td>5 分钟 5 minute</td> <td colspan="2">1 分钟 1 minute</td> </tr> <tr> <td>泄漏电流 Leakage Current</td> <td>0.06CV 或 10μA 取较大值 0.06CV or 10μA whichever is greater</td> <td>0.03CV 或 3μA 取较大值 0.03CV or 3μA whichever is greater</td> <td>CV ≤ 1000</td> <td>CV > 1000</td> </tr> <tr> <td></td> <td></td> <td></td> <td>0.2CV + 40 (μA)</td> <td>0.14CV + 100 (μA)</td> </tr> </table>	额定电压 Rated Voltage	≤ 100V		> 100V		时间 Charge Time	1 分钟 1 minute	5 分钟 5 minute	1 分钟 1 minute		泄漏电流 Leakage Current	0.06CV 或 10μA 取较大值 0.06CV or 10μA whichever is greater	0.03CV 或 3μA 取较大值 0.03CV or 3μA whichever is greater	CV ≤ 1000	CV > 1000				0.2CV + 40 (μA)	0.14CV + 100 (μA)																					
	额定电压 Rated Voltage	≤ 100V		> 100V																																						
	时间 Charge Time	1 分钟 1 minute	5 分钟 5 minute	1 分钟 1 minute																																						
泄漏电流 Leakage Current	0.06CV 或 10μA 取较大值 0.06CV or 10μA whichever is greater	0.03CV 或 3μA 取较大值 0.03CV or 3μA whichever is greater	CV ≤ 1000	CV > 1000																																						
			0.2CV + 40 (μA)	0.14CV + 100 (μA)																																						
最大损失角正切 Dissipation Factor	<table border="1"> <tr> <td>额定电压 (V) Rated Voltage</td> <td>6.3</td> <td>10</td> <td>16</td> <td>25</td> <td>35</td> <td>50</td> <td>63</td> <td>80</td> <td>100</td> <td>160~250</td> </tr> <tr> <td>损失角 (tan δ) Dissipation Factor</td> <td>0.24</td> <td>0.22</td> <td>0.20</td> <td>0.18</td> <td>0.16</td> <td>0.14</td> <td>0.12</td> <td>0.11</td> <td>0.10</td> <td>0.20</td> </tr> </table>	额定电压 (V) Rated Voltage	6.3	10	16	25	35	50	63	80	100	160~250	损失角 (tan δ) Dissipation Factor	0.24	0.22	0.20	0.18	0.16	0.14	0.12	0.11	0.10	0.20																			
	额定电压 (V) Rated Voltage	6.3	10	16	25	35	50	63	80	100	160~250																															
损失角 (tan δ) Dissipation Factor	0.24	0.22	0.20	0.18	0.16	0.14	0.12	0.11	0.10	0.20																																
注: 电容器容量超过 1,000μF 后, 每增加 1,000μF, 损失角 (tan δ) 增加 0.02. (在 20°C, 120 Hz) Note: For capacitance of more than 1,000μF, the value of D.F should be added 0.02 for every increase of 1,000μF.																																										
耐久性 Load Life	电容器在 85°C 环境中施加额定电压连续 3,000 小时 ($\varnothing 5, \varnothing 6.3$ 为 1,000 小时, $\varnothing 8$ 为 2,000 小时) 后, 冷却至 20°C 测量, 特性应满足: 注: 试验期间, 每隔 250 小时, 电容器两端的直流电压将被反向。 The following specifications shall be satisfied when the capacitors are restored to 20°C after the rated voltage is applied for 3,000 hours at 85°C ($\varnothing 5, \varnothing 6.3$: 1,000 hours, $\varnothing 8$: 2,000hours). Note: During this test the rated DC voltage shall be reversed on the capacitor every 250 hours.																																									
	<table border="1"> <tr> <td>容量变化 Capacitance Change</td> <td colspan="10">± 20%以内 ≤ ± 20% of the initial value</td> </tr> <tr> <td>损失角 (tan δ) D.F</td> <td colspan="10">小于初始规定值的 150% ≤ 150% of the initial specified value</td> </tr> <tr> <td>泄漏电流 Leakage Current</td> <td colspan="10">小于初始规定值 ≤ the initial specified value</td> </tr> </table>										容量变化 Capacitance Change	± 20%以内 ≤ ± 20% of the initial value										损失角 (tan δ) D.F	小于初始规定值的 150% ≤ 150% of the initial specified value										泄漏电流 Leakage Current	小于初始规定值 ≤ the initial specified value								
容量变化 Capacitance Change	± 20%以内 ≤ ± 20% of the initial value																																									
损失角 (tan δ) D.F	小于初始规定值的 150% ≤ 150% of the initial specified value																																									
泄漏电流 Leakage Current	小于初始规定值 ≤ the initial specified value																																									
其它 Others	满足 JIS C5141 之 W 项规定 Satisfies characteristic W of JIS C5141																																									

图形和尺寸 Figure and Dimensions

单位 Unit: mm

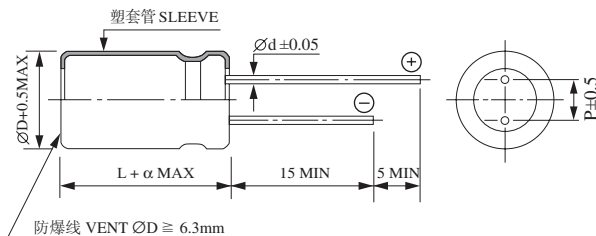

ØD	5	6.3	8	10	13	16	18
Ød	0.5	0.5	0.6	0.6	0.6	0.8	0.8
P	2.0	2.5	3.5	5.0	5.0	7.5	7.5
α	1.5					2.0	

鋁電解電容器

Aluminum Electrolytic Capacitor

MBP 系列

外壳尺寸和最大纹波电流 Case Size and Rated Ripple Current

V μF	6.3	10	16	25	35	50	63	80	100	160	200	250
0.47						5×11 11			5×11 14		8×11.5 13	8×11.5 13
0.68						5×11 14			5×11 17		8×11.5 15	8×11.5 15
1.0						5×11 17			5×11 21	8×11.5 19	8×11.5 19	10×12.5 22
1.5						5×11 20			6.3×11 28	8×11.5 22	10×12.5 27	10×12.5 27
2.2						5×11 25		5×11 29	6.3×11 34	8×11.5 27	10×12.5 33	10×16 37
3.3						5×11 27	5×11 28	6.3×11 39	6.3×11 39	10×12.5 40	10×16 45	10×20 50
4.7						5×11 32	6.3×11 39	6.3×11 47	6.3×11 47	10×12.5 48	10×20 59	
6.8						6.3×11 42	6.3×11 47	6.3×11 56	8×11.5 58	10×16 65		
10				5×11 41	5×11 43	6.3×11 52	6.3×11 57	8×11.5 65	8×11.5 71	10×20 84		
15			5×11 46	5×11 50	6.3×11 60	6.3×11 63	8×11.5 78	8×11.5 79	10×16 111	13×20 123		
22		5×11 53	5×11 57	6.3×11 68	6.3×11 73	8×11.5 89	8×11.5 95	10×16 125	10×16 135	13×25 160		
33	5×11 63	5×11 65	5×11 70	6.3×11 84	8×11.5 100	8×11.5 105	8×11.5 115	10×16 150	13×20 220			
47	5×11 76	5×11 79	6.3×11 95	6.3×11 100	8×11.5 120	10×12.5 150	10×12.5 180	10×20 195	13×20 240			
68	5×11 90	6.3×11 107	6.3×11 114	8×11.5 135	10×12.5 167	10×16 199	10×20 235	13×20 285	13×25 330			
100	6.3×11 125	6.3×11 130	8×11.5 160	8×11.5 168	10×16 230	10×20 265	13×20 320	13×25 350	16×25 425			
150	8×11.5 175	8×11.5 185	10×12.5 225	10×12.5 240	10×20 310	13×20 360	13×25 430	16×25 460	16×31.5 570			
220	8×11.5 215	8×11.5 224	10×12.5 275	10×16 320	13×20 410	13×25 480	16×25 575	16×31.5 615	18×35.5 720			
330	8×11.5 265	10×16 360	10×16 375	13×20 470	13×20 505	16×25 650	16×31.5 760	18×35.5 830				
470	10×12.5 370	10×16 428	10×20 485	13×20 570	13×25 655	16×31.5 835	18×35.5 965					
680	10×16 485	10×20 565	13×20 640	13×25 755	16×25 850	18×35.5 1100						
1,000	10×20 650	13×20 750	13×25 855	16×25 1000	16×31.5 1140							
1,500	13×20 900	13×25 1010	16×25 1180	16×31.5 1350								
2,200	13×25 1160	16×25 1330	16×31.5 1510	18×35.5 1670								
3,300	16×25 1570	16×31.5 1750	18×35.5 1980	←←←←← 外壳尺寸 Case Size ØD x L(mm) ←←←←← 纹波电流 Ripple Current (mA rms) 在 85°C, 120Hz								
4,700	16×31.5 2020	18×35.5 2240										
6,800	18×35.5 2600											

鋁電解電容器

Aluminum Electrolytic Capacitor

MKP 系列

双极性, 标准系列. Bi-polar, Standard Series.

- 105°C, 耐久性 1,000 小时.
105°C, Load Life: 1,000 Hours.
- 适用于未知极性或极性翻转电路.
Suitable for Polarity Change or Reverse Circuit.



项目 Item	特性 Specifications																						
额定工作电压 Rated Voltage Range	6.3 ~ 250 VDC																						
工作温度范围 Temperature Range	-40 ~ +105°C																						
容量允许误差 Capacitance Tolerance	± 20% (M) ± 10% (K) (在 20°C, 120 Hz)																						
最大泄漏电流 Leakage Current (双向 in both polarity) (在 20°C)	<table border="1"> <tr> <th>额定电压 Rated Voltage</th> <th colspan="2">≤ 100V</th> <th colspan="2">> 100V</th> </tr> <tr> <th>时间 Charge Time</th> <td>1 分钟 1 minute</td> <td>5 分钟 5 minute</td> <td colspan="2">1 分钟 1 minute</td> </tr> <tr> <th>泄漏电流 Leakage Current</th> <td>0.06CV 或 10μA 取较大值 0.06CV or 10μA whichever is greater</td> <td>0.03CV 或 3μA 取较大值 0.03CV or 3μA whichever is greater</td> <td>CV ≤ 1000</td> <td>CV > 1000</td> </tr> <tr> <td></td> <td></td> <td></td> <td>0.2CV + 40 (μA)</td> <td>0.14CV + 100 (μA)</td> </tr> </table>	额定电压 Rated Voltage	≤ 100V		> 100V		时间 Charge Time	1 分钟 1 minute	5 分钟 5 minute	1 分钟 1 minute		泄漏电流 Leakage Current	0.06CV 或 10μA 取较大值 0.06CV or 10μA whichever is greater	0.03CV 或 3μA 取较大值 0.03CV or 3μA whichever is greater	CV ≤ 1000	CV > 1000				0.2CV + 40 (μA)	0.14CV + 100 (μA)		
	额定电压 Rated Voltage	≤ 100V		> 100V																			
	时间 Charge Time	1 分钟 1 minute	5 分钟 5 minute	1 分钟 1 minute																			
泄漏电流 Leakage Current	0.06CV 或 10μA 取较大值 0.06CV or 10μA whichever is greater	0.03CV 或 3μA 取较大值 0.03CV or 3μA whichever is greater	CV ≤ 1000	CV > 1000																			
			0.2CV + 40 (μA)	0.14CV + 100 (μA)																			
最大损失角正切 Dissipation Factor	<table border="1"> <tr> <th>额定电压 (V) Rated Voltage</th> <td>6.3</td> <td>10</td> <td>16</td> <td>25</td> <td>35</td> <td>50</td> <td>63</td> <td>80</td> <td>100</td> <td>160~250</td> </tr> <tr> <th>损失角 (tan δ) Dissipation Factor</th> <td>0.24</td> <td>0.22</td> <td>0.20</td> <td>0.18</td> <td>0.16</td> <td>0.14</td> <td>0.12</td> <td>0.11</td> <td>0.10</td> <td>0.20</td> </tr> </table>	额定电压 (V) Rated Voltage	6.3	10	16	25	35	50	63	80	100	160~250	损失角 (tan δ) Dissipation Factor	0.24	0.22	0.20	0.18	0.16	0.14	0.12	0.11	0.10	0.20
	额定电压 (V) Rated Voltage	6.3	10	16	25	35	50	63	80	100	160~250												
损失角 (tan δ) Dissipation Factor	0.24	0.22	0.20	0.18	0.16	0.14	0.12	0.11	0.10	0.20													
	注: 电容器容量超过 1,000μF 后, 每增加 1,000μF, 损失角 (tan δ) 增加 0.02. (在 20°C, 120 Hz) Note: For capacitance of more than 1,000μF, the value of D.F should be added 0.02 for every increase of 1,000μF.																						
耐久性 Load Life	<p>电容器在 105°C 环境中施加额定电压连续 1,000 小时后, 冷却至 20°C 测量, 特性应满足: 注: 试验期间, 每隔 250 小时, 电容器两端的直流电压将被反向. The following specifications shall be satisfied when the capacitors are restored to 20°C after the rated voltage is applied for 1,000 hours at 105°C Note: During this test the rated DC voltage shall be reversed on the capacitor every 250 hours.</p>																						
	<table border="1"> <tr> <td>容量变化 Capacitance Change</td> <td>± 20% 以内 ≤ ± 20% of the initial value</td> </tr> <tr> <td>损失角 (tan δ) D.F</td> <td>小于初始规定值的 150% ≤ 150% of the initial specified value</td> </tr> <tr> <td>泄漏电流 Leakage Current</td> <td>小于初始规定值 ≤ the initial specified value</td> </tr> </table>	容量变化 Capacitance Change	± 20% 以内 ≤ ± 20% of the initial value	损失角 (tan δ) D.F	小于初始规定值的 150% ≤ 150% of the initial specified value	泄漏电流 Leakage Current	小于初始规定值 ≤ the initial specified value																
容量变化 Capacitance Change	± 20% 以内 ≤ ± 20% of the initial value																						
损失角 (tan δ) D.F	小于初始规定值的 150% ≤ 150% of the initial specified value																						
泄漏电流 Leakage Current	小于初始规定值 ≤ the initial specified value																						
其它 Others	满足 JIS C5141 之 W 项规定 Satisfies characteristic W of JIS C5141																						

图形和尺寸 Figure and Dimensions

单位 Unit: mm

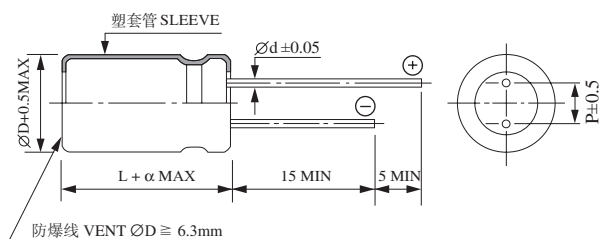

ØD	5	6.3	8	10	13	16	18
Ød	0.5	0.5	0.6	0.6	0.6	0.8	0.8
P	2.0	2.5	3.5	5.0	5.0	7.5	7.5
α	1.5					2.0	

鋁電解電容器

Aluminum Electrolytic Capacitor

MKP 系列

外壳尺寸和最大纹波电流 Case Size and Rated Ripple Current

V μF	6.3	10	16	25	35	50	63	80	100	160	200	250
0.47						5×11 6.5			5×11 8		8×11.5 7.5	8×11.5 7.5
0.68						5×11 8			5×11 10		8×11.5 8.5	8×11.5 8.5
1.0						5×11 10			5×11 12	8×11.5 11	8×11.5 11	10×12.5 13
1.5						5×11 12			6.3×11 16	8×11.5 13	10×12.5 16	10×12.5 16
2.2						5×11 15		5×11 17	6.3×11 20	8×11.5 16	10×12.5 19	10×16 22
3.3						5×11 16	5×11 16	6.3×11 23	6.3×11 23	10×12.5 24	10×16 26	10×20 29
4.7						5×11 19	6.3×11 23	6.3×11 28	6.3×11 28	10×12.5 28	10×20 35	
6.8						6.3×11 28	6.3×11 28	6.3×11 33	8×11.5 34	10×16 38		
10				5×11 24	5×11 25	6.3×11 31	6.3×11 34	8×11.5 38	8×11.5 42	10×20 49		
15			5×11 27	5×11 29	6.3×11 35	6.3×11 37	8×11.5 46	8×11.5 46	10×16 65	13×20 72		
22		5×11 31	5×11 34	6.3×11 40	6.3×11 43	8×11.5 52	8×11.5 56	10×16 74	10×16 79	13×25 94		
33	5×11 37	5×11 38	5×11 41	6.3×11 49	8×11.5 59	8×11.5 62	8×11.5 68	10×16 88	13×20 130			
47	5×11 45	5×11 46	6.3×11 56	6.3×11 59	8×11.5 70	10×12.5 88	10×12.5 106	10×20 115	13×20 140			
68	5×11 53	6.3×11 63	6.3×11 67	8×11.5 79	10×12.5 98	10×16 117	10×20 138	13×20 165	13×25 195			
100	6.3×11 73	6.3×11 76	8×11.5 94	8×11.5 99	10×16 135	10×20 155	13×20 188	13×25 205	16×25 250			
150	8×11.5 102	8×11.5 109	10×12.5 132	10×12.5 141	10×20 180	13×20 210	13×25 250	16×25 270	16×31.5 335			
220	8×11.5 126	8×11.5 131	10×12.5 162	10×16 190	13×20 240	13×25 280	16×25 340	16×31.5 360	18×35.5 425			
330	8×11.5 156	10×16 211	10×16 220	13×20 275	13×20 295	16×25 380	16×31.5 445	18×35.5 490				
470	10×12.5 217	10×16 250	10×20 285	13×20 335	13×25 385	16×31.5 490	18×35.5 565					
680	10×16 285	10×20 330	13×20 375	13×25 445	16×25 500	18×35.5 650						
1,000	10×20 380	13×20 440	13×25 500	16×25 590	16×31.5 670							
1,500	13×20 530	13×25 595	16×25 695	16×31.5 795	18×35.5 940							
2,200	13×25 680	16×25 780	16×31.5 890	18×35.5 980								
3,300	16×25 920	16×31.5 1030	18×35.5 1165	← 外壳尺寸 Case Size ØD x L (mm) ← 纹波电流 Ripple Current (mA rms) 在 105°C, 120Hz								
4,700	16×31.5 1190	18×35.5 1315										
6,800	18×35.5 1530											

鋁電解電容器

Aluminum Electrolytic Capacitor

SBP 系列

- 双极性电容器. Bi-Polar
- 用于高保真音响系统, 具有良好的频率特性.
Use in Speaker Networks of Hi-Fi Sound Audio Systems and Have Excellent Frequency Characteristics
- 不能用于超过最大纹波电流的交流电
Cannot withstand an AC Application Which Exceeds the Specified Maximum Permissible Ripple Current Rating.



项目 Item	特性 Specifications			
额定工作电压 Rated Voltage Range	25 ~ 100 VDC			
工作温度范围 Temperature Range	-40 ~ +85°C			
容量允许误差 Capacitance Tolerance	± 20% (M) ± 10% (K) (在 20°C, 1KHz)			
最大泄漏电流 Leakage Current (双向 in both polarity)	1 分钟后 : 0.06CV (µA) 或 10µA, 取较大值; 5 分钟后 : 0.03CV (µA) 或 3µA, 取较大值. (在 20°C) After 1 minute: 0.06CV or 10µA, whichever is greater; After 5 minute: 0.03CV or 3µA, whichever is greater.			
最大损失角正切 Dissipation Factor	额定电压 Rated Voltage (V)	25	50	100
	损失角 Dissipation Factor (tan δ)	0.14	0.12	0.10
(在 20°C, 1KHz)				
耐久性 Load Life	<p>电容器在 85°C 环境中施加额定电压连续 3,000 小时后, 冷却至 20°C 测量, 特性应满足: 注: 试验期间, 每隔 250 小时, 电容器两端的直流电压将被反向.</p> <p>The following specifications shall be satisfied when the capacitors are restored to 20°C after the rated voltage is applied for 3,000 hours at 85°C Note: During this test the rated DC voltage shall be reversed on the capacitor every 250 hours.</p>			
		容量变化 Capacitance Change	± 15%以内 ≤ ± 15% of the initial value	
		损失角(tan δ) D.F	小于初始规定值的 150% ≤ 150% of the initial specified value	
		泄漏电流 Leakage Current	小于初始规定值 ≤ the initial specified value	
其它 Others	满足 JIS C5141 之 W 项规定 Satisfies characteristic W of JIS C5141			

图形和尺寸 Figure and Dimensions

单位 Unit: mm

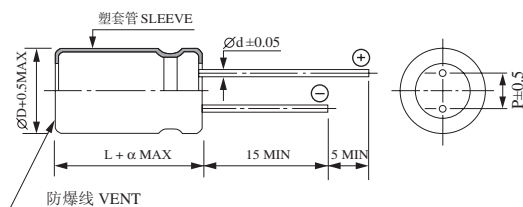

ØD	8	10	13	16
Ød	0.6	0.6	0.6	0.8
P	3.5	5.0	5.0	7.5
α	1.5		2.0	

外壳尺寸和最大纹波电流

Case Size and Rated Ripple Current

V	25		50		100	
µF						
0.33					8x11.5	42
0.47					8x11.5	50
0.68					10x12.5	71
1.0			8x11.5	65	10x12.5	86
1.5	8x11.5	73	8x11.5	80	10x16	115
2.2	8x11.5	88	10x12.5	115	10x20	155
3.3	8x11.5	108	10x12.5	140	10x20	190
4.7	10x12.5	153	10x16	185	10x20	230
6.8	10x12.5	180	10x16	220	10x20	275
10	10x16	250	10x16	270	13x20	390
15	10x16	300	10x20	365	13x20	475
22	10x20	405	10x20	440	13x25	555
33	10x20	495	13x20	630	16x25	875
47	10x20	590	13x20	750	16x31.5	1155
68	13x20	825	13x25	1000		
100	13x25	1100	16x25	1360		

纹波电流 R.C (mA rms) 在 85°C, 1KHz
外壳尺寸 Case Size ØD x L(mm)

鋁電解電容器 Aluminum Electrolytic Capacitor

UBP 系列

- 双极性电容器. Bi-Polar Capacitor.
- 用于电视机或监视器的行扫描电路.
Use in Horizontal Deflection Circuits of TV Sets and Monitors.



项目 Item	特性 Specifications						
额定工作电压 Rated Voltage Range	-40 ~ +85°C						
工作温度范围 Temperatue Range	25, 50V DC						
容量允许误差 Capacitance Tolerance	± 10% (在 20°C, 120kHz)						
最大泄漏电流 Leakage Current (双向 in both polarity)	100μA (5 分钟后) (after 5 minutes) (在 20°C)						
最大损失角正切 Dissipation Factor (tan δ)	0.05 (在 20°C, 120kHz)						
耐久性 Load Life	<p>电容器在 85°C 环境中施加 12V 直流电压和规定的纹波电流 3,000 小时后, 冷却至 20°C 测量, 特性应满足: 注: 试验期间, 每隔 250 小时, 电容器两端的直流电压将被反向</p> <p>The following specifications shall be satisfied when the capacitors are restored to 20°C after DC 12V and specified ripple current applied for 3,000 hours at 85°C Note: During this test the rated DC voltage shall be reversed on the capacitor every 250 hours.</p> <table border="1" style="float: right;"> <tr> <td>容量变化 Capacitance Change</td> <td>± 15%以内 ≤ ± 15% of the initial value</td> </tr> <tr> <td>损失角 (tan δ) D.F</td> <td>小于初始规定值的 200% ≤ 200% of the initial specified value</td> </tr> <tr> <td>泄漏电流 Leakage Current</td> <td>小于初始规定值 ≤ the initial specified value</td> </tr> </table>	容量变化 Capacitance Change	± 15%以内 ≤ ± 15% of the initial value	损失角 (tan δ) D.F	小于初始规定值的 200% ≤ 200% of the initial specified value	泄漏电流 Leakage Current	小于初始规定值 ≤ the initial specified value
容量变化 Capacitance Change	± 15%以内 ≤ ± 15% of the initial value						
损失角 (tan δ) D.F	小于初始规定值的 200% ≤ 200% of the initial specified value						
泄漏电流 Leakage Current	小于初始规定值 ≤ the initial specified value						
储存性 Shelf Life	未加电压的电容器在 85°C 环境中储存 500 小时后, 冷却至 20°C 测量, 特性应满足耐久性规定。 When the capacitors are restored to 20°C after exposing them at 85°C for 500 hours without voltage applied, the specifications shall satisfy the specifications of the load life.						
其它 Others	满足 JIS C5141 之 W 项. Satisfies characteristic W of JIS C5141						

图形和尺寸 Figure and Dimensions

单位 Unit: mm

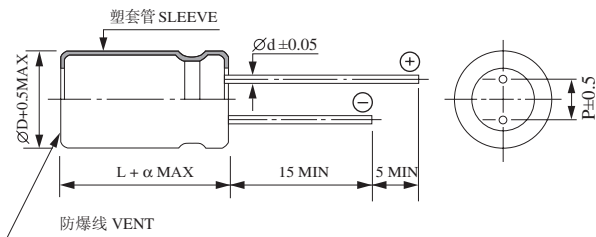

∅D	13	16	18
∅d	0.6	0.8	0.8
P	5.0	7.5	7.5
α	1.5	2.0	

外壳尺寸和最大纹波电流

Case Size and Rated Ripple Current

V μF	25, 50	
2.2	13x25	5
3.3	16x25	6
4.7	16x31.5	7
5.6	16x35.5	7.5
6.8	16x35.5	8
10	18x35.5	10

纹波电流 R.C (A p - p) 在 85°C, 15.75KHz
外壳尺寸 Case Size ∅D x L(mm)
(p - p): 峰-峰电流 Peak-Peak Current

鋁電解電容器

Aluminum Electrolytic Capacitor

HT 系列

- 高温 125°C 产品. High Temperature 125°C Products.
- 125°C, 耐久性 1,000 小时. 125°C, Load Life 1,000 Hours.
- 适用于高可靠性设备, 开关电源的滤波电路和工业控制设备
Suitable for High Reliability Equipment, Filtering Circuit of Switching Power Supply and Industrial Control Equipment.



项目 Item	特性 Specifications												
额定工作电压 Rated Voltage Range	10 ~ 50 VDC												
工作温度范围 Temperature Range	-40 ~ +125°C												
容量允许误差 Capacitance Tolerance	± 20% (在 20°C, 120 Hz)												
最大泄漏电流 Leakage Current	1 分钟后, 漏电流 0.03CV 或 4μA, 取较大值. After 1 minute, 0.03CV or 4μA, whichever is greater. (在 20°C)												
最大损失角正切 Dissipation Factor	<table border="1"> <tr> <td>额定电压 (V) Rated Voltage</td> <td>10</td> <td>16</td> <td>25</td> <td>35</td> <td>50</td> </tr> <tr> <td>损失角 (tan δ) D.F</td> <td>0.20</td> <td>0.16</td> <td>0.14</td> <td>0.12</td> <td>0.10</td> </tr> </table> <p>注: 电容器容量超过 1,000μF 后, 每增加 1,000μF, 损失角 (tan δ) 增加 0.02. (在 20°C, 120 Hz) Note: For capacitance of more than 1,000μF, the value of D.F should be added 0.02 for every increase of 1,000μF.</p>	额定电压 (V) Rated Voltage	10	16	25	35	50	损失角 (tan δ) D.F	0.20	0.16	0.14	0.12	0.10
额定电压 (V) Rated Voltage	10	16	25	35	50								
损失角 (tan δ) D.F	0.20	0.16	0.14	0.12	0.10								
耐久性 Load Life	<p>电容器在 125°C 环境中施加额定电压连续 1,000 小时后, 冷却至 20°C 测量, 特性应满足: The following specifications shall be satisfied when the capacitors are restored to 20°C after the rated voltage is applied for 1,000 hours at 125°C</p> <table border="1"> <tr> <td>容量变化 Capacitance Change</td> <td>± 20% 以内 ≤ ± 20% of the initial value</td> </tr> <tr> <td>损失角 (tan δ) D.F</td> <td>小于初始规定值的 200% ≤ 200% of the initial specified value</td> </tr> <tr> <td>泄漏电流 Leakage Current</td> <td>小于初始规定值 ≤ the initial specified value</td> </tr> </table>	容量变化 Capacitance Change	± 20% 以内 ≤ ± 20% of the initial value	损失角 (tan δ) D.F	小于初始规定值的 200% ≤ 200% of the initial specified value	泄漏电流 Leakage Current	小于初始规定值 ≤ the initial specified value						
容量变化 Capacitance Change	± 20% 以内 ≤ ± 20% of the initial value												
损失角 (tan δ) D.F	小于初始规定值的 200% ≤ 200% of the initial specified value												
泄漏电流 Leakage Current	小于初始规定值 ≤ the initial specified value												
储存性 Shelf Life	电容器在 125°C 环境中放置 500 小时后, 冷却至 20°C 测量, 特性应满足耐久性规定。 When the capacitors are restored to 20°C after exposing them at 125°C for 1,000 hours without voltage applied, the specifications shall satisfy the specifications of the load life.												
其它 Others	满足 JIS C5141 之 W 项规定. Satisfies characteristic W of JIS C5141												

图形和尺寸 Figure and Dimensions

单位 Unit: mm

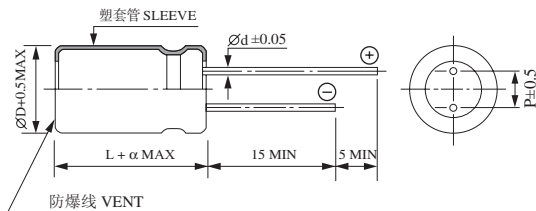

ØD	8	10	13	16	18
Ød	0.6	0.6	0.6	0.8	0.8
P	3.5	5.0	5.0	7.5	7.5
α	1.5			2.0	

纹波电流频率系数 Frequency Multiplying Factor of Ripple Current

容量(μF) \ 频率(Hz)	120	300	1K	10K~
CV < 1000	0.50	0.64	0.83	1.00
CV ≥ 1000	0.67	0.79	0.91	1.00

外壳尺寸, 阻抗和最大纹波电流 Case Size, Impedance and Rated Ripple Current

Item μF	10			16			25			35			50		
	尺寸 ØDxL	阻抗 Ω	纹波电流 mA rms	尺寸 ØDxL	阻抗 Ω	纹波电流 mA rms	尺寸 ØDxL	阻抗 Ω	纹波电流 mA rms	尺寸 ØDxL	阻抗 Ω	纹波电流 mA rms	尺寸 ØDxL	阻抗 Ω	纹波电流 mA rms
1.0													8x11.5	2.00	35
2.2													8x11.5	1.80	50
3.3													8x11.5	1.50	60
4.7													8x11.5	1.15	85
10													8x11.5	0.75	180
22													8x11.5	0.50	250
33													8x11.5	0.45	300
47													8x11.5	0.35	440
100				8x11.5	0.32	340	8x11.5	0.13	500	10x12.5	0.15	620	10x12.5	0.18	555
220	8x11.5	0.26	340	10x12.5	0.15	620	10x12.5	0.10	680	10x16	0.094	790	10x20	0.098	930
330	10x12.5	0.15	620	10x12.5	0.10	680	10x16	0.075	945	10x20	0.075	950	13x20	0.070	1330
470	10x12.5	0.10	680	10x16	0.075	945	10x20	0.057	1100	13x20	0.058	1330	13x25	0.055	1650
1,000	10x20	0.057	1100	13x20	0.042	1490	13x25	0.033	1750	16x25	0.031	2010	16x31.5	0.031	2430
2,200	13x20	0.033	1750	16x25	0.024	2300	16x31.5	0.020	2710	18x35.5	0.025	2790			
3,300	16x25	0.024	2300	16x31.5	0.020	2710	18x31.5	0.017	3310	额定纹波电流 Ripple Current 在 125°C, 10KHz ~ 100KHz 阻抗 Impedance (Ωmax) 在 20°C 100KHz					
4,700	16x31.5	0.020	2710	18x31.5	0.018	3270									

鋁電解電容器

Aluminum Electrolytic Capacitor

MLI 系列

- 小型, 低等效串联电阻和阻抗. Miniaturized, Low Impedance.
- 适用于高可靠性的直流-直流转换器和开关电源电路.
Suitable for Application in High Reliability, Miniaturized Switching Power Supplies, DC-DC Converter.
- 105°C, 耐久性 3,000 小时. (Ø5, Ø6.3 为 1,000 小时, Ø8 为 2,000 小时)
105°C, Load Life: 3,000 Hours. (Ø5, Ø6.3: 1,000Hours, Ø8: 2,000Hours)



项目 Item	特性 Specifications																
额定工作电压 Rated Voltage Range	6.3 ~ 100 VDC																
工作温度范围 Temperature Range	-55 ~ +105°C																
容量允许误差 Capacitance Tolerance	± 20% (在 20°C, 120 Hz)																
最大泄漏电流 Leakage Current	1 分钟后, 0.03CV 或 4µA, 取较大值. After 1 minute, 0.03CV or 4µA, whichever is greater (在 20°C)																
最大损失角正切 Dissipation Factor (在 20°C, 120 Hz)	<table border="1"> <tr> <td>额定电压 (V) Rated Voltage</td> <td>6.3</td> <td>10</td> <td>16</td> <td>25</td> <td>35</td> <td>50</td> <td>63 ~ 100</td> </tr> <tr> <td>损失角(tan δ) D.F</td> <td>0.22</td> <td>0.19</td> <td>0.16</td> <td>0.14</td> <td>0.12</td> <td>0.10</td> <td>0.08</td> </tr> </table> <p>注: 电容器容量超过 1,000µF 后, 每增加 1,000µF, 损失角(tan δ)增加 0.02. Note: For capacitance of more than 1,000µF, the value of D.F should be added 0.02 for every increase of 1,000µF.</p>	额定电压 (V) Rated Voltage	6.3	10	16	25	35	50	63 ~ 100	损失角(tan δ) D.F	0.22	0.19	0.16	0.14	0.12	0.10	0.08
额定电压 (V) Rated Voltage	6.3	10	16	25	35	50	63 ~ 100										
损失角(tan δ) D.F	0.22	0.19	0.16	0.14	0.12	0.10	0.08										
低温特性 Low Temperature Characteristics	<table border="1"> <tr> <td>额定电压(V) Rated Voltage</td> <td>6.3 ~ 10</td> <td>16</td> <td>25 ~ 35</td> <td>50 ~ 100</td> </tr> <tr> <td>阻抗比 Z-55°C/Z+20°C Impedance Ratio</td> <td>4</td> <td>3</td> <td>3</td> <td>2</td> </tr> </table>	额定电压(V) Rated Voltage	6.3 ~ 10	16	25 ~ 35	50 ~ 100	阻抗比 Z-55°C/Z+20°C Impedance Ratio	4	3	3	2						
额定电压(V) Rated Voltage	6.3 ~ 10	16	25 ~ 35	50 ~ 100													
阻抗比 Z-55°C/Z+20°C Impedance Ratio	4	3	3	2													
耐久性 Load Life	<p>电容器在 105°C 环境中施加额定电压连续 3,000 小时(Ø5, Ø6.3 为 1,000 小时, Ø8 为 2,000 小时)后, 冷却至 20°C 测量, 特性应满足: The following specifications shall be satisfied when the capacitors are restored to 20°C after the rated voltage is applied for 3,000 hours at 105°C (Ø5, Ø6.3: 1,000 hours, Ø8: 2,000hours).</p> <table border="1"> <tr> <td>容量变化 Capacitance Change</td> <td>± 20%以内 ≤ ± 20% of the initial value</td> </tr> <tr> <td>损失角(tan δ) D.F</td> <td>小于初始规定值的 200% ≤ 200% of the initial specified value</td> </tr> <tr> <td>泄漏电流 Leakage Current</td> <td>小于初始规定值 ≤ the initial specified value</td> </tr> </table>	容量变化 Capacitance Change	± 20%以内 ≤ ± 20% of the initial value	损失角(tan δ) D.F	小于初始规定值的 200% ≤ 200% of the initial specified value	泄漏电流 Leakage Current	小于初始规定值 ≤ the initial specified value										
容量变化 Capacitance Change	± 20%以内 ≤ ± 20% of the initial value																
损失角(tan δ) D.F	小于初始规定值的 200% ≤ 200% of the initial specified value																
泄漏电流 Leakage Current	小于初始规定值 ≤ the initial specified value																
储存性 Shelf Life	未加电压的电容器放置在 105°C 环境中连续 1,000 小时, 然后冷却至 20°C 测量, 特性应满足耐久性规定。 When the capacitors are restored to 20°C after exposing them at 105°C for 1,000 hours without voltage applied, the specifications shall satisfy the specifications of the load life.																
其它 Others	满足 JIS C5141 之 W 项规定. Satisfies characteristic W of JIS C5141																

图形和尺寸 Figure and Dimensions

单位 Unit: mm

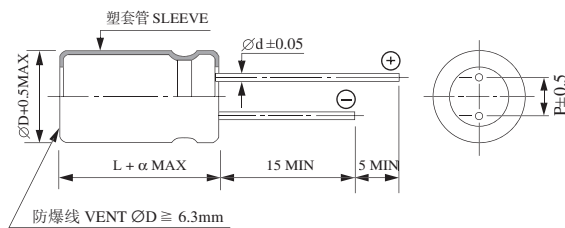

ØD	5	6.3	8	10	13	16	18
Ød	0.5	0.5	0.6	0.6	0.6	0.8	0.8
P	2.0	2.5	3.5	5.0	5.0	7.5	7.5
α	1.5					2.0	

纹波电流频率系数

Frequency Multiplying Factor of Ripple Current

容量 (µF) Capacitance	频率 Frequency (Hz)					
	50	120	300	1K	10K	100K
~ 4.7	0.30	0.40	0.50	0.70	0.80	1.00
5.6 ~ 33	0.40	0.50	0.60	0.80	0.90	1.00
39 ~ 330	0.50	0.70	0.80	0.90	0.95	1.00
390 ~ 1000	0.70	0.80	0.90	0.98	1.00	1.00
1200 或以上 or up	0.80	0.90	0.95	0.98	1.00	1.00

鋁電解電容器

Aluminum Electrolytic Capacitor

MLI 系列

外壳尺寸 Case Size

μF \ V	6.3	10	16	25	35	50	63	80	100
0.47						5×11			5×11
0.68						5×11			5×11
1.0						5×11			5×11
1.5						5×11			5×11
2.2						5×11			5×11
3.3						5×11			5×11
4.7						5×11		5×11	6.3×11
6.8						5×11		5×11	6.3×11
10						5×11	5×11	6.3×11	6.3×11
12						5×11	5×11	6.3×11	6.3×11
15						5×11	6.3×11	6.3×11	6.3×15
18						5×11	6.3×11	6.3×11	6.3×15
22					5×11	6.3×11	6.3×11	6.3×15	8×11.5
27					5×11	6.3×11	6.3×11	6.3×15	8×15
33				5×11	6.3×11	6.3×11	6.3×15	8×11.5	8×15
39				5×11	6.3×11	6.3×11	6.3×15	8×15	8×20
47			5×11	6.3×11	6.3×11	6.3×15	8×11.5	8×15	10×20
56			5×11	6.3×11	6.3×11	6.3×15	8×15	8×20	10×20
68		5×11	6.3×11	6.3×11	6.3×15	8×11.5	8×15	10×20	10×25
82		5×11	6.3×11	6.3×11	6.3×15	8×15	8×20	10×20	10×31.5
100	5×11	6.3×11	6.3×11	6.3×15	8×11.5	8×20	10×20	10×25	10×31.5
120	5×11	6.3×11	6.3×11	6.3×15	8×15	8×20	10×20	10×31.5	13×25
150	6.3×11	6.3×11	6.3×15	8×11.5	8×15	10×20	10×25	10×31.5	13×25
180	6.3×11	6.3×11	6.3×15	8×15	8×20	10×20	10×31.5	13×25	13×31.5
220	6.3×11	6.3×15	8×11.5	8×15	8×20	10×25	13×20	13×31.5	13×35.5
270	6.3×15	6.3×15	8×15	8×20	10×20	10×31.5	13×25	13×31.5	13×40
330	6.3×15	8×11.5	8×15	8×20	10×20	10×31.5	13×25	13×35.5	16×31.5
390	8×11.5	8×15	8×20	10×20	10×25	13×25	13×31.5	13×40	16×35.5
470	8×15	8×15	8×20	10×20	10×31.5	13×25	13×35.5	16×31.5	16×40
560	8×15	8×20	10×20	10×25	13×20	13×31.5	13×40	16×35.5	18×35.5
680	8×20	8×20	10×20	10×31.5	13×25	13×35.5	16×31.5	16×40	18×40
820	8×20	10×20	10×25	13×20	13×25	13×40	16×35.5	18×35.5	
1,000	10×20	10×20	10×31.5	13×25	13×31.5	16×31.5	16×40	18×40	
1,200	10×20	10×25	13×20	13×25	13×35.5	16×35.5	18×40		
1,500	10×25	10×31.5	13×25	13×31.5	13×40	16×40			
1,800	10×31.5	13×20	13×31.5	13×35.5	16×31.5	18×35.5			
2,200	10×31.5	13×25	13×31.5	13×40	16×35.5	18×40			
2,700	13×25	13×31.5	13×35.5	16×31.5	16×40				
3,300	13×25	13×35.5	13×40	16×35.5	18×40				
3,900	13×31.5	13×40	16×31.5	16×40					
4,700	13×35.5	16×31.5	16×35.5	18×40					
5,600	13×40	16×35.5	16×40						
6,800	16×31.5	16×35.5	18×35.5						
8,200	16×35.5	16×40	18×40						
10,000	16×40	18×40							
12,000	18×35.5								
15,000	18×40								

鋁電解電容器

Aluminum Electrolytic Capacitor

MLI 系列

外壳尺寸, 阻抗和最大纹波电流 Case Size, Impedance and Rated Ripple Current

V Item μF	外壳尺寸 Case Size ØDxL(mm)	6.3				10				
		阻抗 Impedance (ΩMAX)		纹波电流 R.C (mA rms)		阻抗 Impedance (ΩMAX)		纹波电流 R.C (mA rms)		
		20°C/100KHz	-10°C/100KHz	105°C/10KHz ~200KHz	105°C/120Hz	20°C/100KHz	-10°C/100KHz	105°C/10KHz ~200KHz	105°C/120Hz	
68						5×11	1.30	3.30	155	97
82						5×11	1.10	2.80	175	110
100	5×11	1.40	3.50	150	99	6.3×11	0.84	2.10	210	135
120	5×11	1.10	2.80	175	115	6.3×11	0.72	1.80	235	160
150	6.3×11	0.78	2.10	225	155	6.3×11	0.55	1.40	265	185
180	6.3×11	0.60	1.50	250	175	6.3×11	0.46	1.20	290	205
220	6.3×11	0.48	1.20	285	205	6.3×15	0.38	0.95	370	270
270	6.3×15	0.39	1.00	370	275	6.3×15	0.31	0.78	405	300
330	6.3×15	0.32	0.80	405	310	8×11.5	0.26	0.65	460	350
390	8×11.5	0.27	0.68	445	345	8×15	0.22	0.55	550	430
470	8×15	0.22	0.55	550	435	8×15	0.19	0.48	595	475
560	8×15	0.19	0.48	595	480	8×20	0.16	0.40	730	590
680	8×20	0.16	0.40	730	605	8×20	0.13	0.33	795	660
820	8×20	0.13	0.33	795	670	10×20	0.11	0.28	985	835
1,000	10×20	0.12	0.30	950	820	10×20	0.096	0.24	1060	915
1,200	10×20	0.10	0.25	1020	895	10×25	0.078	0.20	1280	1120
1,500	10×25	0.084	0.21	1220	1090	10×31.5	0.072	0.18	1440	1290
1,800	10×31.5	0.078	0.20	1370	1230	13×20	0.057	0.14	1470	1320
2,200	10×31.5	0.066	0.17	1470	1320	13×50	0.045	0.11	1710	1530
2,700	13×25	0.051	0.14	1590	1430	13×31.5	0.036	0.090	1940	1740
3,300	13×25	0.045	0.11	1710	1530	13×35.5	0.032	0.08	2180	1960
3,900	13×31.5	0.037	0.093	1910	1710	13×40	0.030	0.075	2360	2120
4,700	13×35.5	0.034	0.085	2100	1890	16×31.5	0.028	0.070	2420	2170
5,600	13×40	0.031	0.078	2270	2040	16×35.5	0.026	0.065	2610	2340
6,800	16×31.5	0.029	0.073	2370	2130	16×35.5	0.024	0.060	2680	2410
8,200	16×35.5	0.027	0.068	2550	2290	16×40	0.023	0.058	2820	2530
10,000	16×40	0.025	0.063	2750	2470	18×40	0.021	0.053	3040	2730
12,000	18×35.5	0.023	0.058	2820	2530					
15,000	18×40	0.022	0.055	2960	2660					

V Item μF	外壳尺寸 Case Size ØDxL(mm)	16				25				
		阻抗 Impedance (ΩMAX)		纹波电流 R.C (mA rms)		阻抗 Impedance (ΩMAX)		纹波电流 R.C (mA rms)		
		20°C/100KHz	-10°C/100KHz	105°C/10KHz ~200KHz	105°C/120Hz	20°C/100KHz	-10°C/100KHz	105°C/10KHz ~200KHz	105°C/120Hz	
33						5×11	1.30	3.30	155	88
39						5×11	1.10	2.80	175	100
47	5×11	1.30	3.30	155	92	6.3×11	0.84	2.10	210	125
56	5×11	1.10	2.80	175	105	6.3×11	0.72	1.80	235	140
68	6.3×11	0.78	2.00	220	135	6.3×11	0.57	1.40	260	160
82	6.3×11	0.66	1.70	240	155	6.3×11	0.47	1.20	285	180
100	6.3×11	0.55	1.40	265	175	6.3×15	0.39	0.98	370	245
120	6.3×11	0.45	1.10	290	195	6.3×15	0.32	0.80	405	275
150	6.3×15	0.37	0.93	375	260	8×11.5	0.26	0.65	460	320
180	6.3×15	0.31	0.78	405	285	8×15	0.22	0.55	550	390
220	8×11.5	0.26	0.65	460	335	8×15	0.18	0.45	625	455
270	8×15	0.22	0.55	550	410	8×20	0.15	0.38	750	560
330	8×15	0.18	0.45	595	455	8×20	0.13	0.33	795	610
390	8×20	0.16	0.40	730	570	10×20	0.11	0.28	985	770
470	8×20	0.14	0.35	770	615	10×20	0.10	0.25	1020	810
560	10×20	0.12	0.30	950	770	10×25	0.084	0.21	1220	990
680	10×20	0.10	0.25	1020	845	10×31.5	0.072	0.18	1420	1180
820	10×25	0.084	0.21	1220	1030	13×20	0.059	0.15	1430	1210
1,000	10×31.5	0.072	0.18	1410	1210	13×25	0.048	0.12	1660	1430
1,200	13×20	0.060	0.15	1430	1250	13×25	0.043	0.11	1760	1550
1,500	13×25	0.048	0.12	1660	1490	13×31.5	0.035	0.088	1980	1780
1,800	13×31.5	0.039	0.10	1880	1690	13×35.5	0.032	0.080	2180	1960
2,200	13×31.5	0.034	0.085	2010	1800	13×40	0.029	0.073	2360	2120
2,700	13×35.5	0.031	0.078	2220	1990	16×31.5	0.027	0.068	2470	2220
3,300	13×40	0.028	0.070	2410	1260	16×35.5	0.025	0.063	2680	2410
3,900	16×31.5	0.027	0.068	2470	2220	16×40	0.023	0.058	2820	2530
4,700	16×35.5	0.025	0.063	2680	2410	18×40	0.022	0.055	2960	2660
5,600	16×40	0.024	0.060	2820	2530					
6,800	18×35.5	0.022	0.055	2900	2610					
8,200	18×40	0.021	0.053	3040	2730					

鋁 電 解 電 容 器

Aluminum Electrolytic Capacitor

MLI 系列

外壳尺寸, 阻抗和最大纹波电流 Case Size, Impedance and Rated Ripple Current

Item μF	V	35				50					
		外壳尺寸 Case Size ØDxL(mm)	阻抗 Impedance (ΩMAX)		纹波电流 R.C (mA rms)		外壳尺寸 Case Size ØDxL(mm)	阻抗 Impedance (ΩMAX)		纹波电流 R.C (mA rms)	
			20° C/100KHz	-10° C/100KHz	105° C/10KHz ~200KHz	105° C/120Hz		20° C/100KHz	-10° C/100KHz	105° C/10KHz ~200KHz	105° C/120Hz
0.47						5×11	31.0	80.0	22	11	
0.68						5×11	21.0	55.0	28	14	
1.0						5×11	14.0	38.0	36	18	
1.5						5×11	9.80	28.0	45	22	
2.2						5×11	6.50	18.0	54	27	
3.3						5×11	4.60	12.0	66	33	
4.7						5×11	3.10	7.80	81	40	
6.8						5×11	2.50	6.30	91	45	
10						5×11	2.00	5.00	115	57	
12						5×11	1.70	4.30	125	62	
15						5×11	1.30	3.30	145	72	
18						5×11	1.10	2.80	155	79	
22		5×11	1.30	3.30	160	85	6.3×11	0.91	2.30	195	100
27		5×11	1.00	2.50	180	99	6.3×11	0.74	1.90	215	115
33		6.3×11	0.78	2.00	225	125	6.3×11	0.60	1.50	240	135
39		6.3×11	0.66	1.70	245	140	6.3×11	0.50	1.30	260	150
47		6.3×11	0.54	1.40	270	160	6.3×15	0.42	1.10	330	195
56		6.3×11	0.45	1.10	295	180	6.3×15	0.35	0.88	360	220
68		6.3×15	0.37	0.93	370	230	8×11.5	0.28	0.70	410	255
82		6.3×15	0.31	0.78	415	265	8×15	0.22	0.55	500	320
100		8×11.5	0.26	0.65	460	305	8×20	0.18	0.45	620	410
120		8×15	0.22	0.55	550	370	8×20	0.16	0.40	670	455
150		8×15	0.18	0.45	595	415	10×20	0.13	0.33	820	570
180		8×20	0.16	0.40	730	520	10×20	0.11	0.28	890	635
220		8×20	0.13	0.33	795	580	10×25	0.098	0.25	1040	760
270		10×20	0.11	0.28	985	735	10×31.5	0.085	0.21	1200	900
330		10×20	0.096	0.24	1060	810	10×31.5	0.072	0.18	1300	995
390		10×25	0.084	0.21	1220	955	13×25	0.053	0.13	1440	1120
470		10×31.5	0.072	0.18	1420	1130	13×25	0.048	0.12	1500	1190
560		13×20	0.059	0.15	1430	1160	13×31.5	0.040	0.10	1680	1360
680		13×25	0.048	0.12	1660	1370	13×35.5	0.036	0.090	1850	1530
820		13×25	0.042	0.11	1760	1490	13×40	0.033	0.083	2010	1700
1,000		13×31.5	0.035	0.088	1980	1710	16×31.5	0.030	0.075	2120	1830
1,200		13×35.5	0.031	0.078	2180	1920	16×35.5	0.028	0.070	2260	1990
1,500		13×40	0.029	0.073	2360	2120	16×40	0.026	0.065	2410	2170
1,800		16×31.5	0.027	0.068	2470	2220	18×35.5	0.025	0.063	2460	2210
2,200		16×35.5	0.024	0.060	2680	2410	18×40	0.024	0.060	2560	2300
2,700		16×40	0.022	0.055	2900	2610					
3,300		18×40	0.021	0.053	3040	2730					

Item μF	V	63				80					
		外壳尺寸 Case Size ØDxL(mm)	阻抗 Impedance (ΩMAX)		纹波电流 R.C (mA rms)		外壳尺寸 Case Size ØDxL(mm)	阻抗 Impedance (ΩMAX)		纹波电流 R.C (mA rms)	
			20° C/100KHz	-10° C/100KHz	105° C/10KHz ~200KHz	105° C/120Hz		20° C/100KHz	-10° C/100KHz	105° C/10KHz ~200KHz	105° C/120Hz
4.7						5×11	4.20	11.00	53	26	
6.8						5×11	2.60	7.00	68	34	
10		5×11	1.60	4.00	135	67	6.3×11	1.70	4.60	87	43
12		5×11	1.40	3.50	145	72	6.3×11	1.40	3.80	96	48
15		6.3×11	1.10	2.80	185	92	6.3×11	1.20	3.20	104	52
18		6.3×11	0.95	2.40	195	100	6.3×11	1.00	2.70	114	58
22		6.3×11	0.78	2.00	215	110	6.3×15	0.77	2.10	135	71
27		6.3×11	0.64	1.60	240	130	6.3×15	0.63	1.70	149	80
33		6.3×15	0.52	1.30	305	170	8×11.5	0.53	1.40	234	132
39		6.3×15	0.45	1.10	330	190	8×15	0.46	1.20	272	156
47		8×11.5	0.37	0.93	365	215	8×15	0.39	1.10	295	175
56		8×15	0.31	0.78	450	275	8×20	0.34	0.92	347	208
68		8×15	0.26	0.65	500	315	10×20	0.28	0.76	426	264
82		8×20	0.22	0.55	600	385	10×20	0.25	0.68	447	284
100		10×20	0.18	0.45	750	495	10×25	0.21	0.57	556	347
120		10×20	0.15	0.38	820	555	10×31.5	0.18	0.49	606	406
150		10×25	0.13	0.33	950	665	10×31.5	0.15	0.41	663	459
180		10×31.5	0.11	0.28	1110	790	13×25	0.13	0.35	734	520
220		13×20	0.094	0.24	1140	835	13×31.5	0.12	0.32	816	595
270		13×25	0.081	0.20	1340	1000	13×31.5	0.10	0.27	894	667
330		13×25	0.072	0.18	1420	1090	13×35.5	0.088	0.24	1000	767
390		13×31.5	0.059	0.15	1620	1260	13×40	0.078	0.21	1060	822
470		13×35.5	0.052	0.13	1780	1420	16×31.5	0.069	0.19	1450	1150
560		13×40	0.047	0.12	1950	1580	16×35.5	0.062	0.17	1600	1300
680		16×31.5	0.043	0.11	2050	1700	16×40	0.055	0.15	1770	1470
820		16×35.5	0.040	0.10	2220	1880	18×35.5	0.049	0.13	1890	1590
1,000		16×40	0.037	0.093	2370	2050	18×40	0.044	0.12	2080	1790
1,200		18×40	0.034	0.085	2510	2210					

MLI 系列

外壳尺寸, 阻抗和最大纹波电流

Case Size, Impedance and Rated Ripple Current

V Item μF	外壳尺寸 Case Size ØD×L(mm)	100			
		阻抗 Impedance (ΩMAX)		纹波电流 R.C (mA rms)	
		20° C/100KHz	-10° C/100KHz	105° C/10KHz ~200KHz	105° C/120Hz
0.47	5×11	43.0	116.0	17	8
0.68	5×11	23.0	62.0	23	11
1.0	5×11	17.0	46.0	27	13
1.5	5×11	10.0	27.0	35	17
2.2	5×11	6.60	18.0	43	21
3.3	5×11	4.10	11.0	54	27
4.7	6.3×11	2.80	7.60	68	34
6.8	6.3×11	1.90	5.10	83	41
10	6.3×11	1.20	3.20	104	52
12	6.3×11	1.00	2.70	114	57
15	6.3×15	0.81	2.20	131	65
18	6.3×15	0.67	1.80	155	73
22	8×11.5	0.55	1.50	230	122
27	8×15	0.47	1.30	269	146
33	8×15	0.38	1.00	299	169
39	8×20	0.33	0.89	352	202
47	10×20	0.28	0.76	423	252
56	10×20	0.24	0.65	456	274
68	10×25	0.21	0.57	526	326
82	10×31.5	0.18	0.49	606	386
100	10×31.5	0.15	0.41	863	438
120	13×25	0.13	0.35	774	519
150	13×25	0.11	0.30	798	553
180	13×31.5	0.098	0.26	904	641
220	13×35.5	0.087	0.23	1000	730
270	13×40	0.072	0.19	1130	843
330	16×31.5	0.062	0.17	1520	1160
390	16×35.5	0.053	0.14	1730	1340
470	16×40	0.047	0.13	1920	1530
560	18×35.5	0.041	0.11	2070	1680
680	18×40	0.036	0.097	2300	1910

鋁電解電容器

Aluminum Electrolytic Capacitor

MLC 系列

- 超低阻抗, 高纹波电流. Extremely Low Impedance.
- 105°C, 耐久性 3,000 小时 (Ø8 为 2,000 小时).
- 105°C, Load Life: 3,000 Hours (Ø8: 2,000 小时).
- 适合于开关电源或需要高纹波电流的场合.
- Suitable for Power Supply or High Ripple Current Circuit.



项目 Item	特性 Specifications																
额定工作电压 Rated Voltage Range	6.3 ~ 63 VDC																
工作温度范围 Temperature Range	-55 ~ +105°C																
容量允许误差 Capacitance Tolerance	± 20% (在 20°C, 120 Hz)																
最大泄漏电流 Leakage Current	在 1 分钟后, 0.01CV 或 4µA, 取较大值. After 1 minute, 0.01CV or 4µA, whichever is greater (在 20°C)																
最大损失角正切 Dissipation Factor (在 20°C, 120 Hz)	<table border="1"> <tr> <td>额定电压 (V) Rated Voltage</td> <td>6.3</td> <td>10</td> <td>16</td> <td>25</td> <td>35</td> <td>50</td> <td>63 ~ 100</td> </tr> <tr> <td>损失角(tan δ) D.F</td> <td>0.22</td> <td>0.19</td> <td>0.16</td> <td>0.14</td> <td>0.12</td> <td>0.10</td> <td>0.08</td> </tr> </table> <p>注: 电容器容量超过 1,000µF 后, 每增加 1,000µF, 损失角(tan δ) 增加 0.02. Note: For capacitance of more than 1,000µF, the value of D.F should be added 0.02 for every increase of 1,000µF.</p>	额定电压 (V) Rated Voltage	6.3	10	16	25	35	50	63 ~ 100	损失角(tan δ) D.F	0.22	0.19	0.16	0.14	0.12	0.10	0.08
额定电压 (V) Rated Voltage	6.3	10	16	25	35	50	63 ~ 100										
损失角(tan δ) D.F	0.22	0.19	0.16	0.14	0.12	0.10	0.08										
浪涌电压 Surge Voltage	<table border="1"> <tr> <td>额定电压 (V) Rated Voltage</td> <td>6.3</td> <td>10</td> <td>16</td> <td>25</td> <td>35</td> <td>50</td> <td>63</td> </tr> <tr> <td>浪涌电压 (V) Surge Voltage</td> <td>8</td> <td>13</td> <td>20</td> <td>32</td> <td>44</td> <td>63</td> <td>79</td> </tr> </table>	额定电压 (V) Rated Voltage	6.3	10	16	25	35	50	63	浪涌电压 (V) Surge Voltage	8	13	20	32	44	63	79
额定电压 (V) Rated Voltage	6.3	10	16	25	35	50	63										
浪涌电压 (V) Surge Voltage	8	13	20	32	44	63	79										
低温特性 Low Temperature Characteristics	<table border="1"> <tr> <td>额定电压 (V) Rated Voltage</td> <td>6.3 ~ 16</td> <td>25 ~ 63</td> </tr> <tr> <td>Z - 25°C/ Z +20°C</td> <td>3</td> <td>2</td> </tr> <tr> <td>Z - 55°C/ Z +20°C</td> <td>6</td> <td>4</td> </tr> </table>	额定电压 (V) Rated Voltage	6.3 ~ 16	25 ~ 63	Z - 25°C/ Z +20°C	3	2	Z - 55°C/ Z +20°C	6	4							
额定电压 (V) Rated Voltage	6.3 ~ 16	25 ~ 63															
Z - 25°C/ Z +20°C	3	2															
Z - 55°C/ Z +20°C	6	4															
耐久性 Load Life	<p>电容器在 105°C 环境中施加额定电压连续 3,000 小时(Ø8 为 2,000 小时) 后, 冷却至 20°C 测量, 特性应满足:</p> <p>The following specifications shall be satisfied when the capacitors are restored to 20°C after the rated voltage is applied for 3,000 hours at 105°C (Ø8: 2,000hours).</p> <table border="1"> <tr> <td>容量变化 Capacitance Change</td> <td>± 20%以内 ≤ ± 20% of the initial value</td> </tr> <tr> <td>损失角(tan δ) D.F</td> <td>小于初始规定值的 200% ≤ 200% of the initial specified value</td> </tr> <tr> <td>泄漏电流 Leakage Current</td> <td>小于初始规定值 ≤ the initial specified value</td> </tr> </table>	容量变化 Capacitance Change	± 20%以内 ≤ ± 20% of the initial value	损失角(tan δ) D.F	小于初始规定值的 200% ≤ 200% of the initial specified value	泄漏电流 Leakage Current	小于初始规定值 ≤ the initial specified value										
容量变化 Capacitance Change	± 20%以内 ≤ ± 20% of the initial value																
损失角(tan δ) D.F	小于初始规定值的 200% ≤ 200% of the initial specified value																
泄漏电流 Leakage Current	小于初始规定值 ≤ the initial specified value																
其它 Others	满足 JIS C5141 之 W 项规定. Satisfies characteristic W of JIS C5141																

图形和尺寸 Figure and Dimensions

单位 Unit: mm

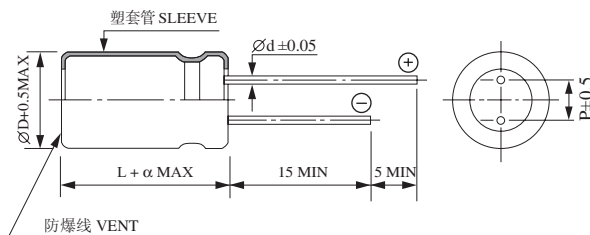

ØD	8	10	13	16
Ød	0.6	0.6	0.6	0.8
P	3.5	5.0	5.0	7.5
α	1.5			2.0

纹波电流频率系数

Frequency Multiplying Factor of Ripple Current

频率 (Hz)	50	120	300	1K	10K	100K
6.3 ~ 16	0.53	0.69	0.83	0.93	0.98	1.00
25 ~ 35	0.42	0.55	0.71	0.85	0.97	1.00
50 ~ 63	0.37	0.47	0.67	0.81	0.94	1.00

鋁電解電容器

Aluminum Electrolytic Capacitor

MLC 系列

外壳尺寸, 阻抗和最大纹波电流 Case Size, Impedance and Rated Ripple Current

V Item μF	6.3			10			16			25		
	外壳尺寸 ØDxL (mm)	阻抗 (ΩMAX) 20°C 100KHz	纹波电流 (A rms) 105°C 100KHz	外壳尺寸 ØDxL (mm)	阻抗 (ΩMAX) 20°C 100KHz	纹波电流 (A rms) 105°C 100KHz	外壳尺寸 ØDxL (mm)	阻抗 (ΩMAX) 20°C 100KHz	纹波电流 (A rms) 105°C 100KHz	外壳尺寸 ØDxL (mm)	阻抗 (ΩMAX) 20°C 100KHz	纹波电流 (A rms) 105°C 100KHz
100							8×11.5	0.348	0.27	8×11.5	0.330	0.34
220				8×11.5	0.190	0.36	8×15	0.180	0.44	10×16	0.170	0.59
330	8×11.5	0.160	0.40	8×15	0.152	0.50	10×16	0.144	0.57	10×18	0.136	0.76
470	8×15	0.130	0.53	10×16	0.124	0.62	10×18	0.118	0.71	10×20	0.112	0.95
680	10×16	0.103	0.68	10×18	0.098	0.78	10×20	0.093	0.90	13×20	0.088	1.21
1,000	10×18	0.084	0.87	10×20	0.080	1.00	13×20	0.076	1.16	13×25	0.072	1.62
2,200	13×20	0.048	1.33	13×25	0.046	1.61	13×30	0.043	1.89	13×40	0.041	2.70
3,300	13×30	0.040	1.85	13×30	0.038	2.00	13×40	0.036	2.44	16×40	0.034	3.04
4,700	13×40	0.034	2.26	13×40	0.032	2.50	16×40	0.031	2.64			
6,800	16×40	0.029	2.70									

V Item μF	35			50			63		
	外壳尺寸 ØDxL (mm)	阻抗 (ΩMAX) 20°C 100KHz	纹波电流 (A rms) 105°C 100KHz	外壳尺寸 ØDxL (mm)	阻抗 (ΩMAX) 20°C 100KHz	纹波电流 (A rms) 105°C 100KHz	外壳尺寸 ØDxL (mm)	阻抗 (ΩMAX) 20°C 100KHz	纹波电流 (A rms) 105°C 100KHz
47				8×11.5	0.453	0.29	8×15	0.424	0.35
68	8×11.5	0.374	0.30	8×15	0.352	0.39	10×16	0.330	0.43
100	8×15	0.311	0.40	10×16	0.292	0.49	10×18	0.274	0.55
220	10×18	0.161	0.66	10×20	0.151	0.80	13×20	0.142	0.92
330	10×25	0.129	0.93	13×20	0.121	1.04	13×25	0.113	1.24
470	13×20	0.105	1.07	13×25	0.099	1.37	13×30	0.093	1.61
680	13×25	0.083	1.42	13×30	0.078	1.79	16×35.5	0.073	2.09
1,000	13×30	0.068	1.87	13×40	0.064	2.48			
2,200	16×40	0.039	2.83						

鋁電解電容器

Aluminum Electrolytic Capacitor

MST 系列

标准系列, 普通用途. Standard Series, General Use.

- 85°C, 耐久性 4,000 小时.
($\varnothing 5$, $\varnothing 6.3$ 为 2,000 小时, $\varnothing 8$ 为 3,000 小时)
85°C, Load Life 4,000 Hours
($\varnothing 5$, $\varnothing 6.3$: 2,000Hours, $\varnothing 8$: 3,000 Hours)



项目 Item	特性 Specifications										
额定工作电压 Rated Voltage Range	6.3 ~ 450 VDC										
工作温度范围 Temperature Range	-40 ~ +85°C (6.3 ~ 250 V), -25 ~ +85°C (350 ~ 450 V)										
容量允许误差 Capacitance Tolerance	± 20% (在 20°C, 120 Hz)										
最大泄漏电流 Leakage Current (在 20°C)	额定电压 Rated Voltage	≤ 100V	> 100V								
	时间 Charge Time	1 分钟 1 minute	2 分钟 2 minute	1 分钟 1 minute							
	泄漏电流 Leakage Current	0.03CV 或 4 μ A 取较大值	0.01CV 或 3 μ A 取较大值	CV ≤ 1000	CV > 1000						
		0.03CV 或 4 μ A whichever is greater	0.01CV 或 3 μ A whichever is greater	0.1CV + 40 (μ A)	0.04CV + 100 (μ A)						
最大损失角正切 Dissipation Factor	额定电压 (V) Rated Voltage	6.3	10	16	25	35	50	63	100	160~250	350~450
	损失角 (tan δ) D.F	0.24	0.20	0.16	0.14	0.12	0.10	0.09	0.08	0.20	0.24
注: 电容器容量超过 1,000 μ F 后, 每增加 1,000 μ F, 损失角 (tan δ) 增加 0.02. (在 20°C, 120 Hz) Note: For capacitance of more than 1,000 μ F, the value of D.F should be added 0.02 for every increase of 1,000 μ F.											
耐久性 Load Life	电容器在 85°C 环境中施加额定电压连续 4,000 小时 ($\varnothing 5$, $\varnothing 6.3$ 为 2,000 小时, $\varnothing 8$ 为 3,000 小时) 后, 冷却至 20°C 测量, 特性应满足: The following specifications shall be satisfied when the capacitors are restored to 20°C after the rated voltage is applied for 4,000 hours at 85°C ($\varnothing 5$, $\varnothing 6.3$: 2,000 hours, $\varnothing 8$: 3,000hours)										
	容量变化 Capacitance Change	± 20% 以内 ≤ ± 20% of the initial value									
	损失角 (tan δ) D.F	小于初始规定值的 200% ≤ 200% of the initial specified value									
其它 Others	满足 JIS C5141 之 W 项规定. Satisfies characteristic W of JIS C5141										

图形和尺寸 Figure and Dimensions

单位 Unit: mm

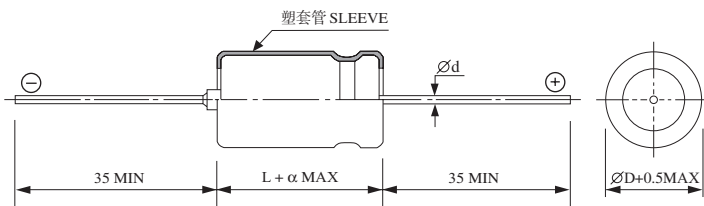

ØD	5	6.3	8	10	13	16	18	22
Ød	0.6	0.6	0.6	0.6	0.6	0.8	0.8	0.8
α	1.5				2.0			

纹波电流频率系数

Frequency Multiplying Factor of Ripple Current

V	Hz					
	μ F	50	120	300	1K	10K
6.3 ~ 100	~ 68	0.75	1.00	1.35	1.57	2.00
	100 ~ 680	0.80	1.00	1.23	1.34	1.50
	1000 ~ 22000	0.85	1.00	1.10	1.13	1.15
160 ~ 450	1.0 ~ 220	0.80	1.00	1.25	1.40	1.60
	330 ~	0.90	1.00	1.10	1.13	1.15

鋁電解電容器

Aluminum Electrolytic Capacitor

MST 系列

外壳尺寸和最大纹波电流 Case Size and Rated Ripple Current

V μF	6.3	10	16	25	35	50	63	100	160	200	250	350	400	450
0.47						5×12 5		5×12 10						
0.68						5×12 8		5×12 14						
1.0						5×12 10		5×12 18	6.3×12 13	6.3×12 13	6.3×16 14	6.3×16 12	8×16 14	8×16 14
2.2						5×12 23		5×12 28	6.3×16 23	6.3×16 23	8×16 27	8×16 24	8×20 28	10×20 31
3.3						5×12 28		5×12 34	8×16 33	8×16 33	8×16 33	8×20 32	10×20 38	10×20 38
4.7						5×12 34		6.3×12 40	8×16 39	8×16 39	8×20 45	10×20 46	10×20 46	10×25 49
6.8						5×12 41		6.3×12 48	8×16 47	8×16 47	8×20 54	10×20 55	10×20 55	10×25 60
10						5×12 50	5×12 55	6.3×16 60	8×20 60	10×20 73	10×20 70	13×25 85	13×25 85	13×25 85
22					5×12 70	6.3×12 85	6.3×12 90	8×16 120	10×25 120	13×25 140	13×25 140	13×31.5 140	16×31.5 15	16×31.5 150
33				5×12 80	6.3×12 90	6.3×16 110	6.3×16 120	8×16 150	13×25 170	13×25 170	13×31.5 190	16×31.5 190	16×40 210	18×40 220
47			5×12 85	6.3×12 100	6.3×16 120	6.3×16 130	8×16 160	8×20 190	13×31.5 230	13×31.5 230	16×31.5 260	16×40 260	18×40 290	18×40 290
68		6.3×12 107	6.3×16 132	6.3×16 159	8×16 170	8×16 180	8×20 210	10×20 250	13×31.5 270	16×31.5 300	16×31.5 310	16×40 310	18×40 340	22×42 370
100	5×12 110	6.3×12 130	6.3×16 160	6.3×16 170	8×16 210	8×16 220	8×20 260	10×25 340	16×31.5 370	16×40 430	16×40 430	18×40 390	22×42 440	
220	6.3×16 200	6.3×16 210	8×16 300	8×16 280	8×20 340	10×20 410	10×25 480	13×25 560	16×4 610	18×40 650	22×42 740			
330	6.3×16 250	8×16 300	8×16 320	8×20 380	10×20 460	10×25 560	13×25 650	13×31.5 750	18×40 790	22×42 910				
470	8×16 330	8×16 350	8×20 430	10×20 460	10×25 610	13×25 730	13×31.5 840	16×31.5 970	22×42 1080					
680	8×20 430	8×20 460	10×20 570	10×25 610	13×25 790	13×31.5 960	13×31.5 1010	16×4 1290						
1,000	10×20 600	10×20 640	10×25 770	13×25 900	13×31.5 1060	16×31.5 1260	16×31.5 1330	22×42 1910						
2,200	13×25 1020	13×25 1090	13×31.5 1180	16×31.5 1480	16×31.5 1580	18×40 1920	22×42 2530							
3,300	13×25 1200	13×31.5 1390	16×31.5 1620	16×40 1710	16×20 2050	22×42 2620								
4,700	16×31.5 1500	16×31.5 1730	16×40 1840	18×40 2170	18×40 2420									
6,800	16×31.5 1600	16×40 1930	18×40 2310	18×40 2380	22×42 3000	← 外壳尺寸 Case Size ØD x L (mm) ← 纹波电流 Ripple Current (mA rms) 在 85°C, 120Hz								
10,000	16×40 1840	18×40 2350	18×40 2450	22×42 2800										
22,000	22×42 2640													



鋁電解電容器 Aluminum Electrolytic Capacitor

MBT 系列

双极性, 标准系列. Bi-Polar, Standard Series.

- 适用于未知极性或极性翻转电路
Suitable for Polarity Change or Reverse Circuit.
- 85°C, 耐久性 3,000 小时 (Ø8 及以下为 2,000 小时)
85°C, Load Life: 3,000 Hours (Ø8 and below: 2,000Hours)



项目 Item	特性 Specifications									
额定工作电压 Rated Voltage Range	6.3 ~ 100 VDC									
工作温度范围 Temperature Range	-40 ~ +85°C									
容量允许误差 Capacitance Tolerance	± 20% (在 20°C, 120 Hz)									
最大泄漏电流 Leakage Current (双向 in both polarity)	1 分钟, 0.06CV 或 10µA, 取较大值. 5 分钟, 0.03CV 或 3µA 取较大值. (在 20°C) After 1 minute, 0.06CV or 10µA, whichever is greater. After 5 minute, 0.03CV or 3µA, whichever is greater.									
最大损失角正切 Dissipation Factor (在 20°C, 120 Hz)	额定电压 (V) Rated Voltage	6.3	10	16	25	35	50	63	80	100
	损失角 (tan δ) D.F	0.26	0.24	0.22	0.20	0.16	0.14	0.12	0.11	0.10
注: 电容器容量超过 1,000µF 后, 每增加 1,000µF, 损失角 (tan δ) 增加 0.02. Note: For capacitance of more than 1,000µF, the value of D.F should be added 0.02 for every increase of 1,000µF.										
耐久性 Load Life	电容器在 85°C 环境中施加额定电压连续 3,000 小时 (Ø8 及以下为 2,000 小时) 后, 冷却至 20°C 测量, 特性应满足: 注: 试验期间, 每隔 250 小时, 电容器两端的直流电压将被反向 The following specifications shall be satisfied when the capacitors are restored to 20°C after the rated voltage is applied for 3,000 hours at 85°C (Ø5, Ø6.3: 1,000 hours, Ø8: 2,000hours). Note: During this test, the rated DC voltage shall be reversed on the capacitor every 250 hours.									
	容量变化 Capacitance Change	± 20% 以内 ≤ ± 20% of the initial value								
损失角 (tan δ) D.F	小于初始规定值的 200% ≤ 200% of the initial specified value									
泄漏电流 Leakage Current	小于初始规定值 ≤ the initial specified value									
其它 Others	满足 JIS C5141 之 W 项规定									

图形和尺寸 Figure and Dimensions

单位 Unit: mm

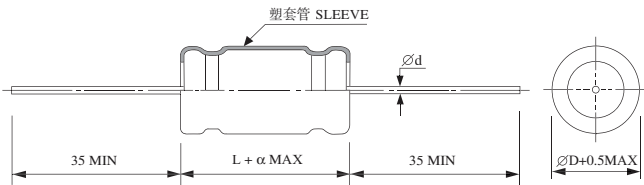

ØD	6.3	8	10	13	16	18
Ød	0.6	0.6	0.6	0.6	0.8	0.8
α	1.5			2.0		

外壳尺寸和最大纹波电流 Case Size and Rated Ripple Current

V µF	6.3	10	16	25	35	50	63	80	100									
0.47						6.3×14	9		6.3×14	13								
0.68						6.3×14	11		6.3×14	15								
1.0						6.3×14	13		6.3×14	19								
1.5						6.3×14	16		6.3×14	23								
2.2						6.3×14	19		6.3×14	28								
3.3						6.3×14	24	6.3×14	6.3×14	31								
4.7						6.3×14	28	6.3×14	6.3×14	38								
6.8						6.3×14	34	6.3×14	6.3×17	56								
10					6.3×14	37	6.3×14	40	6.3×17	68								
15		6.3×14	41	6.3×14	43	6.3×14	45	6.3×14	49	6.3×17	66	6.3×17	71	8×17	79	10×20	90	
22	6.3×14	47	6.3×14	49	6.3×14	52	6.3×14	55	6.3×14	59	6.3×17	80	8×17	91	10×20	100	10×25	135
33	6.3×14	58	6.3×14	60	6.3×14	64	6.3×14	68	6.3×17	90	8×17	110	10×20	135	10×25	120	13×25	180
47	6.3×14	69	6.3×14	72	6.3×14	77	6.3×17	91	8×17	115	10×20	133	10×25	158	10×25	160	13×25	195
68	6.3×14	78	6.3×14	87	6.3×17	103	8×17	125	8×17	140	10×20	160	10×25	190	13×25	230	13×30	270
100	6.3×14	101	6.3×17	120	6.3×17	125	8×17	150	10×20	187	10×25	215	13×25	260	13×30	285	16×32	345
150	6.3×17	142	6.3×17	148	8×17	180	10×20	225	10×25	250	13×25	295	13×30	350	16×32	375	18×36	465
220	8×17	175	8×17	182	10×20	250	10×25	260	10×25	300	13×30	390	16×32	465	18×36	500	18×40	585
330	8×17	215	10×20	295	10×20	305	10×25	380	13×25	410	16×32	530	18×36	615	18×40	675		
470	10×20	330	10×20	350	10×25	395	13×25	465	13×30	530	16×36	680	18×40	785				
680	10×20	395	10×25	460	13×25	520	13×30	615	16×32	690	18×36	895						
1,000	10×25	530	13×25	610	13×30	695	16×32	814	16×36	925								
1,500	13×25	730	13×30	820	16×32	960	16×36	1100	18×40	1285								
2,200	13×30	945	16×32	1080	16×36	1230	18×36	136										
3,300	16×32	1275	16×36	1425	18×36	161												
4,700	16×36	1645	18×36	1820														
6,800	18×36	2115																

纹波电流 R.C (mA rms) 在 85°C, 120Hz
外壳尺寸 Case Size ØD x L(mm)

鋁電解電容器

Aluminum Electrolytic Capacitor

SBT 系列

双极性.Bi-Polar.

- 适用于高保真音响系统, 具有良好的频率特性。
Use in Speaker Cross Over Networks of Hi-Fi Sound Audio Systems and Have Excellent Frequency Characteristics
- 不能耐受超过最大纹波电流的交流电
Cannot Withstand an AC Application and Cannot Exceeds the Specified Maximum Permissible Ripple Current Rating.



项目 Item	特性 Specifications			
额定工作电压 Rated Voltage Range	25 ~ 100 VDC			
工作温度范围 Temperature Range	-40 ~ +85°C			
容量允许误差 Capacitance Tolerance	± 20% (M) ± 10% (K) (在 20°C, 1KHz)			
最大泄漏电流 Leakage Current (双向 in both polarity)	1 分钟后 : 0.06CV (μA)或 10μA, 取较大值; 5 分钟后 : 0.03CV (μA) 或 3μA, 取较大值. (在 20°C) After 1 minute: 0.06CV or 10μA, whichever is greater; After 5 minute: 0.03CV or 3μA, whichever is greater.			
最大损失角正切 Dissipation Factor	额定电压 Rated Voltage (V)	25	50	100
	损失角 Dissipation Factor (tan δ)	0.14	0.12	0.10
(在 20°C, 1KHz)				
耐久性 Load Life	电容器在 85°C 环境中施加额定电压连续 3,000 小时(Ø8 及以下为 2,000 小时)后, 冷却至 20°C 测量, 特性应满足: 注: 试验期间, 每隔 250 小时, 电容器两端的直流电压将被反向。 The following specifications shall be satisfied when the capacitors are restored to 20°C after the rated voltage is applied for 3,000 hours (Ø8 and below: 2,000 hours) at 85°C. Note: During this test, the rated DC voltage shall be reversed on the capacitor every 250 hours.			
	容量变化 Capacitance Change	± 15%以内 ≤ ± 15% of the initial value		
	损失角(tan δ) D.F	小于初始规定值的 150% ≤ 150% of the initial specified value		
其它 Others	满足 JIS C5141 之 W 项规定 Satisfies characteristic W of JIS C5141			

容量变化 Capacitance Change	± 15%以内 ≤ ± 15% of the initial value
损失角(tan δ) D.F	小于初始规定值的 150% ≤ 150% of the initial specified value
泄漏电流 Leakage Current	小于初始规定值 ≤ the initial specified value

图形和尺寸 Figure and Dimensions

单位 Unit: mm

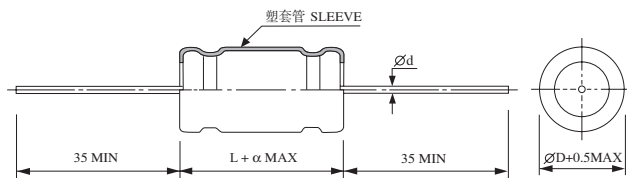

ØD	6.3	8	10	13	16	18
Ød	0.6	0.6	0.6	0.6	0.8	0.8
α	1.5			2.0		

外壳尺寸和最大纹波电流 Case Size and Rated Ripple Current

V μF	25		50		100	
0.33					6.3x17	32
0.47					8x17	43
0.68			6.3x14	38	8x17	52
1.0	6.3x14	43	6.3x17	51	10x20	77
1.5	6.3x17	58	8x17	79	10x25	105
2.2	6.3x17	70	10x20	105	13x25	146
3.3	8x17	97	10x20	128	13x30	195
4.7	10x20	140	10x25	170	16x32	265
6.8	10x20	170	13x25	235	16x36	340
10	10x25	225	13x30	310	18x36	440
15	13x25	320	16x32	435		
22	13x30	420	18x36	595		
33	16x32	600	18x40	760		
47	18x36	805				
68	18x40	1010				

纹波电流 R.C (mA rms) 在 85°C, 1KHz
外壳尺寸 Case Size ØD x L(mm)

鋁電解電容器

Aluminum Electrolytic Capacitor

LSR 系列

- 标准系列, 焊针引线.
Standard Series, Snap-In Type.
- 85°C, 耐久性 3,000 小时.
85°C, Load Life: 3,000Hours



项目 Item	特性 Specifications																				
额定工作电压 Rated Voltage Range	6.3 ~ 450 VDC																				
工作温度范围 Temperature Range	-40 ~ +85°C (6.3 ~ 350V), -25 ~ +85°C (400 ~ 450V)																				
容量允许误差 Capacitance Tolerance	± 20% (在 20°C, 120 Hz)																				
最大泄漏电流 Leakage Current	$3\sqrt{CV}$ (μA) (5 分钟以后) (After 5 minutes) (在 20°C)																				
最大损失角正切 Dissipation Factor	<table border="1"> <thead> <tr> <th>额定电压 Rated Voltage (V)</th> <th>10</th> <th>16</th> <th>25</th> <th>35</th> <th>50</th> <th>63</th> <th>100</th> <th>160~350</th> <th>350~450</th> </tr> </thead> <tbody> <tr> <td>损失角 D.F (tan δ)</td> <td>0.40</td> <td>0.35</td> <td>0.35</td> <td>0.30</td> <td>0.25</td> <td>0.25</td> <td>0.20</td> <td>0.15</td> <td>0.20</td> </tr> </tbody> </table>	额定电压 Rated Voltage (V)	10	16	25	35	50	63	100	160~350	350~450	损失角 D.F (tan δ)	0.40	0.35	0.35	0.30	0.25	0.25	0.20	0.15	0.20
	额定电压 Rated Voltage (V)	10	16	25	35	50	63	100	160~350	350~450											
损失角 D.F (tan δ)	0.40	0.35	0.35	0.30	0.25	0.25	0.20	0.15	0.20												
注: 电容器容量超过 1,000μF 后, 每增加 1,000μF, 损失角(tan δ)增加 0.02. (在 20°C, 120 Hz) Note: For capacitance of more than 1,000μF, the value of D.F should be added 0.02 for every increase of 1,000μF.																					
耐久性 Load Life	电容器在 85°C 环境中施加额定电压连续 3,000 小时后, 冷却至 20°C 测量, 特性应满足: The following specifications shall be satisfied when the capacitors are restored to 20°C after the rated voltage is applied for 3,000 hours at 85°C	容量变化 Capacitance Change	± 20%以内 ≤ ± 20% of the initial value																		
		损失角(tan δ) D.F	小于初始规定值的 200% ≤ 200% of the initial specified value																		
其它 Others	满足 JIS C5141 之 W 项规定. Satisfies characteristic W of JIS C5141.	泄漏电流 Leakage Current	小于初始规定值 ≤ the initial specified value																		

图形和尺寸 Figure and Dimensions

单位 Unit: mm

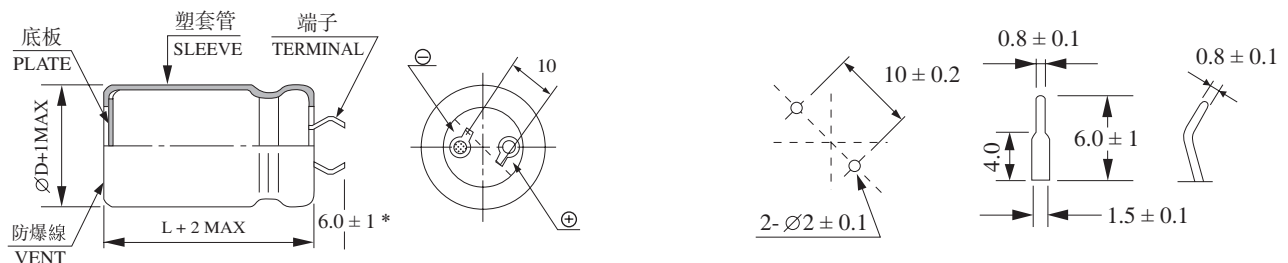

*可以按要求提供 4.0±0.5mm 长度端子

* 4.0±0.5mm length of terminal can be supplied upon customer's request.

纹波电流频率系数

Frequency Multiplying Factor of Ripple Current

电压(V) \ 频率(Hz)	50	120	300	1K	10K~
~ 100	0.88	1.00	1.07	1.15	1.15
160 ~ 250	0.81	1.00	1.17	1.32	1.45
315 ~	0.77	1.00	1.16	1.30	1.41

鋁電解電容器

Aluminum Electrolytic Capacitor

LSR 系列

外壳尺寸和最大纹波电流 Case Size and Rated Ripple Current

V μF ∅D	10				16				25				35			
	22	25.4	30	35	22	25.4	30	35	22	25.4	30	35	22	25.4	30	35
4,700													22x30 3.06	25.4x25 2.98		
5,600									22x25 2.65				22x35 3.28	25.4x30 3.39		
6,800									22x30 3.06	25.4x25 3.15			22x40 3.73	25.4x30 3.67	30x25 3.76	
8,200									22x35 3.45	25.4x30 3.57			22x45 4.13	25.4x35 4.10	30x30 4.22	
10,000					22x25 3.32				22x40 3.95	25.4x30 3.89	30x25 3.99		22x50 4.68	25.4x40 4.68	30x30 4.58	
12,000	22x25 3.31				22x30 3.55	25.4x25 3.89			22x45 4.41	25.4x35 4.37	30x30 4.50			25.4x45 5.18	30x35 5.11	35x30 5.24
15,000	22x30 3.82	25.4x25 3.39			22x35 4.29	25.4x30 4.45	30x25 4.56		22x50 4.94	25.4x40 4.94	30x35 5.10				30x40 5.72	35x35 5.88
18,000	22x35 4.28	25.4x25 4.17			22x40 4.77	25.4x35 4.96	30x30 5.10			25.4x45 5.45	30x35 5.38	35x30 5.51			30x45 6.28	35x40 6.46
22,000	22x40 4.79	25.4x30 4.71	30x25 4.83		22x50 5.51	25.4x40 5.51	30x30 5.39				30x45 6.22	35x35 6.12				35x45 7.07
27,000	22x45 5.30	25.4x35 5.26	30x30 5.41			25.4x45 6.06	30x35 5.98	35x25 5.80			30x50 6.82	35x35 6.74				
33,000	22x50 5.82	25.4x40 5.81	30x30 5.69	35x25 5.81			30x40 6.56	35x30 6.41				35x45 7.35				
39,000		25.4x45 6.31	30x35 6.22	35x30 6.38			30x45 7.08	35x35 6.96								
47,000		25.4x50 6.83	30x40 6.78	35x30 6.62			30x50 7.62	35x40 7.54								
56,000			30x45 7.31	35x35 7.18				35x45 8.08								
68,000				35x40 7.76				35x50 8.63								

V μF ∅D	50				63				80				100			
	22	25.4	30	35	22	25.4	30	35	22	25.4	30	35	22	25.4	30	35
1,200									22x25 2.24				22x30 2.39	25.4x25 2.46		
1,500									22x30 2.67				22x35 2.83	25.4x30 2.93	30x25 3.00	
1,800					22x25 2.20				22x30 2.92	25.4x25 3.01			22x40 3.26	25.4x35 3.39	30x30 3.49	
2,200					22x30 2.50	25.4x25 2.58			22x35 3.25	25.4x30 3.36	30x25 3.45		22x45 3.58	25.4x40 3.74	30x30 3.66	
2,700					22x35 2.94	25.4x30 3.04			22x40 3.79	25.4x35 3.94	30x30 4.05			25.4x45 4.33	30x35 4.27	35x30 4.37
3,300	22x30 2.97	25.4x25 3.06			22x35 3.14	25.4x30 3.26	30x25 3.34		22x45 4.18	25.4x40 4.36	30x30 4.27			25.4x50 4.76	30x40 4.72	35x35 4.85
3,900	22x35 3.29	25.4x30 3.39			22x40 3.60	25.4x35 3.74	30x30 3.85		22x50 4.75	25.4x45 4.96	30x35 4.89				30x45 5.36	35x35 5.27
4,700	22x40 3.83	25.4x35 3.98	30x25 3.86	35x25 4.19	22x50 4.19	25.4x40 4.19	30x35 4.10	35x30 4.19		25.4x50 5.44	30x40 5.39	35x30 5.27			30x50 5.86	35x40 5.80
5,600	22x45 4.26	25.4x40 4.44	30x30 4.35	35x25 4.44		25.4x45 4.65	30x35 4.58	35x30 4.70			30x45 5.91	35x35 5.81				35x45 6.34
6,800	22x50 4.77	25.4x40 4.76	30x35 4.92	35x30 5.04		25.4x50 5.20	30x40 5.16	35x30 5.04				35x40 5.46				
8,200		25.4x50 5.43	30x40 5.38	35x30 5.26			30x45 5.62	35x35 5.53				35x45 6.91				
10,000			30x45 6.07	35x35 5.97			30x50 6.32	35x40 6.25								
12,000			30x50 6.62	35x40 6.55				35x45 6.83	← 外壳尺寸 Case Size ∅D x L(mm) ← 纹波电流 Ripple Current (A rms) 在 85°C, 120Hz							
15,000				35x45 7.20												
18,000				35x50 7.74												

鋁電解電容器

Aluminum Electrolytic Capacitor

LSR 系列

外壳尺寸和最大纹波电流 Case Size and Rated Ripple Current

V μF ∅D	160				200				250				315			
	22	25.4	30	35	22	25.4	30	35	22	25.4	30	35	22	25.4	30	35
100													22x20 0.68			
120													22x25 0.80	25.4x20 0.82		
150					22x20 0.91				22x25 0.90	25.4x20 0.92			22x30 0.96	25.4x25 0.99	30x20 1.01	
180					22x25 1.09				22x25 0.98	25.4x20 1.01			22x35 1.11	25.4x30 1.15	30x25 1.18	35x20 1.20
220	22x20 1.01				22x25 1.20	25.4x20 1.11			22x25 1.09	25.4x25 1.19	30x20 1.22		22x40 1.29	25.4x30 1.27	30x25 1.30	35x20 1.33
270	22x25 1.20	25.4x20 1.32			22x30 1.42	25.4x25 1.32	30x20 1.35		22x30 1.28	25.4x25 1.32	30x20 1.35		22x45 1.50	25.4x35 1.49	30x30 1.53	35x25 1.56
330	22x25 1.33	25.4x20 1.36			22x30 1.54	25.4x25 1.46	30x20 1.49		22x35 1.50	25.4x30 1.56	30x25 1.60	35x20 1.62	22x50 1.73	25.4x40 1.73	30x35 1.78	35x30 1.83
390	22x25 1.45	25.4x25 1.59	30x20 1.62		22x35 1.79	25.4x25 1.59	30x25 1.74	35x20 1.77	22x40 1.72	25.4x30 1.69	30x25 1.73	35x20 1.77		25.4x45 1.97	30x35 1.94	35x30 1.99
470	22x30 1.69	25.4x25 1.75	30x20 1.78		22x40 2.06	25.4x30 1.86	30x25 1.90	35x20 1.94	22x45 1.98	25.4x35 1.96	30x30 2.02	35x25 2.06			30x40 2.23	35x35 2.29
560	22x35 1.96	25.4x30 2.03	30x25 2.08	35x20 2.12	22x45 2.38	25.4x35 2.14	30x25 2.08	35x25 2.25	22x50 2.26	25.4x40 2.25	30x30 2.20	35x25 2.25				35x40 2.62
680	22x40 2.27	25.4x30 2.23	30x25 2.29	35x20 2.33	22x50 2.73	25.4x40 2.48	30x30 2.43	35x25 2.48		25.4x45 2.60	30x35 2.56	35x30 2.62				35x45 3.01
820	22x45 2.61	25.4x35 2.59	30x30 2.67	35x25 2.73		25.4x45 2.85	30x35 2.81	35x30 2.88				30x40 2.95	35x35 3.03			35x50 3.44
1,000	22x50 3.01	25.4x40 3.01	30x30 2.95	35x25 3.01			30x40 3.26	35x30 3.18				30x45 3.40	35x40 3.50			
1,200		25.4x45 3.23	30x35 3.18	35x30 3.26			30x45 3.49	35x35 3.43					35x45 3.74			
1,500			30x40 3.73	35x35 3.83			30x50 4.06	35x40 4.01					35x50 4.35			
1,800				35x40 4.39				35x45 4.58								

V μF ∅D	350				400				450			
	22	25.4	30	35	22	25.4	30	35	22	25.4	30	35
56									22x30 0.39			
68					22x20 0.56				22x25 0.46	25.4x20 0.47		
82	22x20 0.62				22x25 0.66	25.4x20 0.68			22x30 0.54	25.4x25 0.56	30x20 0.57	
100	22x25 0.73	25.4x20 0.75			22x30 0.78	25.4x25 0.81	30x20 0.82		22x35 0.63	25.4x30 0.65	30x25 0.67	35x20 0.68
120	22x30 0.86	25.4x25 0.88	30x20 0.90		22x30 0.86	25.4x25 0.88	30x20 0.90		22x40 0.73	25.4x35 0.76	30x25 0.73	35x20 0.75
150	22x35 1.01	25.4x30 1.05	30x20 1.01		22x35 1.01	25.4x30 1.05	30x25 1.08	35x20 1.09	22x50 0.89	25.4x40 0.89	30x30 0.87	35x25 0.89
180	22x40 1.17	25.4x35 1.21	30x25 1.18	35x20 1.20	22x40 1.17	25.4x35 1.21	30x25 1.18	35x25 1.28		25.4x45 1.02	30x35 1.01	35x25 0.98
220	22x45 1.35	25.4x35 1.34	30x30 1.38	35x25 1.41	22x45 1.35	25.4x40 1.41	30x30 1.38	35x25 1.41		25.4x50 1.18	30x40 1.17	35x30 1.14
270		25.4x45 1.64	30x35 1.61	35x25 1.65		25.4x45 1.64	30x35 1.61	35x30 1.65			30x45 1.35	35x35 1.33
330		25.4x50 1.89	30x40 1.87	35x30 1.83		25.4x50 1.89	30x40 1.87	35x30 1.83			30x50 1.55	35x40 1.54
390			30x45 2.12	35x35 2.09			30x45 2.12	35x35 2.09				35x45 1.74
470			30x50 2.43	35x40 2.40			30x50 2.43	35x40 2.40				35x50 1.99
560				35x35 2.73				35x40 2.73				
680				35x50 3.13								



鋁電解電容器

Aluminum Electrolytic Capacitor

LKR 系列

- 标准系列, 焊针引线.
Standard Series, Snap-In Type.
- 105°C, 耐久性 2,000 小时.
105°C, Load Life: 2,000Hours



项目 Item	特性 Specifications	
额定工作电压 Rated Voltage Range	6.3 ~ 450 VDC	
工作温度范围 Temperature Range	-40 ~ +105°C (6.3 ~ 350V), -25 ~ +105°C (400 ~ 450V)	
容量允许误差 Capacitance Tolerance	± 20% (在 20°C, 120 Hz)	
最大泄漏电流 Leakage Current	3 \sqrt{CV} (μ A) (5 分钟以后) (After 5 minutes) (在 20°C)	
最大损失角正切 Dissipation Factor	额定电压 Rated Voltage (V)	10 16 25 35 50 63 100 160~350 350~450
	损失角 D.F (tan δ)	0.50 0.40 0.35 0.30 0.25 0.25 0.20 0.15 0.20
注: 电容器容量超过 1,000 μ F 后, 每增加 1,000 μ F, 损失角(tan δ)增加 0.02. (在 20°C, 120 Hz) Note: For capacitance of more than 1,000 μ F, the value of D.F should be added 0.02 for every increase of 1,000 μ F.		
耐久性 Load Life	电容器在 105°C 环境中施加额定电压连续 2,000 小时后, 冷却至 20°C 测量, 特性应满足: The following specifications shall be satisfied when the capacitors are restored to 20°C after the rated voltage is applied for 2,000 hours at 105°C	
	容量变化 Capacitance Change	± 20%以内 ≤ ± 20% of the initial value
	损失角(tan δ) D.F	小于初始规定值的 200% ≤ 200% of the initial specified value
泄漏电流 Leakage Current	小于初始规定值 ≤ the initial specified value	
其它 Others	满足 JIS C5141 之 W 项规定. Satisfies characteristic W of JIS C5141.	

图形和尺寸 Figure and Dimensions

单位 Unit: mm

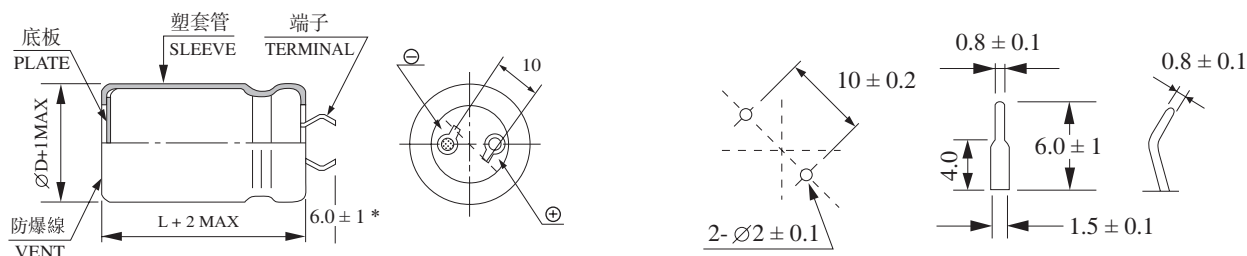

*可以按要求提供 4.0±0.5mm 长度端子

* 4.0±0.5mm length of terminal can be supplied upon customer request.

纹波电流频率系数

Frequency Multiplying Factor of Ripple Current

电压(V) \ 频率(Hz)	50	120	300	1K	10K~
~ 100	0.88	1.00	1.07	1.15	1.15
160 ~ 250	0.81	1.00	1.17	1.32	1.45
315 ~	0.77	1.00	1.16	1.30	1.41

鋁電解電容器



Aluminum Electrolytic Capacitor

LKR 系列

外壳尺寸和最大纹波电流 Case Size and Rated Ripple Current

V μF / ∅D	10				16				25				35			
	22	25.4	30	35	22	25.4	30	35	22	25.4	30	35	22	25.4	30	35
3,300													22x25 1.62			
3,900													22x30 1.88			
4,700									22x25 1.73				22x35 2.14	25.4x25 2.09		
5,600									22x30 1.98				22x35 2.29	25.4x30 2.37	30x25 2.43	
6,800									22x30 2.14				22x40 2.61	25.4x35 2.71	30x30 2.79	
8,200					22x25 2.14				22x35 2.42	25.4x30 2.50			22x50 3.02	25.4x40 3.02	30x30 2.95	
10,000	22x25 2.17				22x30 2.48	25.4x25 2.56			22x40 2.77	25.4x35 2.88				25.4x45 3.43	30x35 3.38	
12,000	22x30 2.48				22x35 2.80	25.4x30 2.90	30x25 2.97		22x45 3.09	25.4x40 3.22	30x30 3.15			25.4x50 3.78	30x40 3.75	35x30 3.67
15,000	22x35 2.83	25.4x25 2.75			22x40 3.17	25.4x35 3.29	30x30 3.38			25.4x45 3.62	30x35 3.57	35x30 3.65			30x45 4.19	35x35 4.12
18,000	22x35 3.00	25.4x30 3.11			22x50 3.50	25.4x40 3.65	30x30 3.57			25.4x50 3.98	30x40 3.95	35x35 4.06				35x40 4.52
22,000	22x40 3.35	25.4x35 3.48	30x25 3.38			25.4x45 4.03	30x35 3.98				30x45 4.36	35x35 4.28				35x45 4.95
27,000	22x50 3.88	25.4x40 3.87	30x30 3.79			25.4x50 4.42	30x40 4.39					35x45 4.92				
33,000		25.4x45 4.26	30x35 4.20				30x45 4.79	35x30 4.29								
39,000		25.4x50 4.60	30x40 4.57	35x30 4.46			30x50 5.16	35x35 4.71								
47,000			30x45 4.95	35x35 4.87				35x40 5.10								
56,000				35x45 5.49				35x45 5.50								

V μF / ∅D	50				63				80				100			
	22	25.4	30	35	22	25.4	30	35	22	25.4	30	35	22	25.4	30	35
820									22x25 1.37				22x30 1.46	25.4x25 1.51		
1,000									22x30 1.62	25.4x25 1.67			22x35 1.71	25.4x30 1.77		
1,200					22x25 1.37				22x30 1.67	25.4x25 1.72			22x40 1.86	25.4x35 1.94	30x25 1.88	
1,500					22x30 1.50	25.4x25 1.54			22x35 1.98	25.4x30 2.05			22x45 2.18	25.4x40 2.28	30x30 2.23	
1,800					22x30 1.64	25.4x25 1.69			22x40 2.28	25.4x35 2.37	30x25 2.30			25.4x45 2.61	30x35 2.57	35x30 2.76
2,200					22x35 1.86	25.4x30 1.92			22x45 2.51	25.4x35 2.49	30x30 2.56			25.4x50 2.85	30x40 2.83	35x35 3.22
2,700	22x30 1.94				22x40 2.17	25.4x30 2.13	30x25 2.18			25.4x40 2.79	30x35 2.99				30x45 3.27	35x40 3.55
3,300	22x35 2.20				22x50 2.53	25.4x40 2.53	30x30 2.48			25.4x45 3.03	30x40 3.30	35x30 3.23			30x50 3.59	35x45 4.03
3,900	22x40 2.52	25.4x35 2.62	30x25 2.54			25.4x45 2.88	30x35 2.84			25.4x50 3.33	30x45 3.75	35x35 3.69				35x50 4.40
4,700	22x45 2.81	25.4x40 2.93	30x30 2.87			25.4x40 3.20	30x40 3.17	35x30 3.10			30x50 4.10	35x40 4.06				
5,600	22x50 3.11	25.4x40 3.11	30x35 3.21				30x45 3.51	35x35 3.46				35x45 4.44				
6,800		25.4x50 3.64	30x40 3.61	35x30 3.53			30x50 3.92	35x40 3.88				35x50 4.90				
8,200			30x45 3.94	35x35 3.87				35x45 4.22								
10,000			30x50 4.42	35x40 4.37				35x50 4.74								
12,000				35x45 4.78												
15,000				35x50 5.24												

 外壳尺寸 Case Size ∅D x L(mm)
 纹波电流 Ripple Current (A rms) 在 105°C, 120Hz

鋁電解電容器

Aluminum Electrolytic Capacitor

LKR 系列

外壳尺寸和最大纹波电流 Case Size and Rated Ripple Current

V μF ∅D	160				200				250				315			
	22	25.4	30	35	22	25.4	30	35	22	25.4	30	35	22	25.4	30	35
82													22x20 0.45			
100													22x25 0.53	25.4x20 0.55		
120													22x30 0.62	25.4x25 0.64	30x20 0.65	
150					22x20 0.63				22x25 0.68	25.4x20 0.69			22x35 0.74	25.4x30 0.76	30x20 0.73	
180	22x20 0.69				22x20 0.69				22x25 0.74	25.4x20 0.76	30x20 0.83		22x40 0.85	25.4x30 0.88	30x25 0.86	35x20 0.87
220	22x20 0.76				22x25 0.82	25.4x20 0.84			22x30 0.88	25.4x25 0.90	30x20 0.92		22x45 0.98	25.4x35 0.98	30x30 1.00	35x20 0.96
270	22x25 0.91	25.4x20 0.93			22x30 0.91	25.4x25 1.00	30x20 1.02		22x35 1.03	25.4x30 1.06	30x25 1.09	35x20 1.11		25.4x45 1.19	30x35 1.17	35x25 1.14
330	22x25 1.01	25.4x25 1.10	30x20 1.13		22x30 1.07	25.4x25 1.11	30x20 1.13		22x40 1.20	25.4x30 1.18	30x25 1.21	35x20 1.23		25.4x50 1.37	30x35 1.36	35x30 1.33
390	22x30 1.17	25.4x25 1.20	30x20 1.23		22x35 1.24	25.4x30 1.28	30x25 1.31	35x20 1.34	22x45 1.36	25.4x40 1.42	30x30 1.39	35x25 1.42			30x45 1.54	35x35 1.52
470	22x35 1.36	25.4x25 1.32	30x25 1.44	35x20 1.47	22x40 1.43	25.4x35 1.40	30x25 1.44	35x25 1.56	22x50 1.56	25.4x40 1.56	30x30 1.53	35x25 1.56			30x50 1.76	35x40 1.74
560	22x40 1.56	25.4x30 1.53	30x25 1.57	35x25 1.70	22x45 1.63	25.4x40 1.62	30x30 1.67	35x25 1.70		25.4x50 1.86	30x35 1.76	35x30 1.80				35x40 1.90
680	22x45 1.80	25.4x35 1.79	30x25 1.73	35x25 1.88	22x50 1.88	25.4x45 1.96	3x30 1.84	35x25 1.88			30x45 2.12	35x35 2.09				35x50 2.27
820	22x50 2.06	25.4x40 2.06	30x30	35x25		25.4x50 2.25	30x35	35x30				35x40 2.40				
1,000		25.4x45 2.38	30x35 2.35	35x30 2.41			30x45 2.57	35x35 2.53				35x45 2.76				
1,200		25.4x50 2.52	30x40 2.50	35x30 2.44			30x50 2.73	35x35 2.57				35x50 2.91				
1,500				35x40 3.00				35x45 3.13								

V μF ∅D	350				400				450			
	22	25.4	30	35	22	25.4	30	35	22	25.4	30	35
47									22x30 0.25			
56					22x20 0.37				22x25 0.29	25.4x20 0.30		
68	22x20 0.41				22x25 0.44	25.4x20 0.45			22x30 0.34	25.4x25 0.35	30x20 0.36	
82	22x25 0.48	25.4x20 0.49			22x30 0.51	25.4x25 0.53	30x20 0.54		22x35 0.40	25.4x30 0.41	30x20 0.40	
100	22x25 0.53	25.4x25 0.59	30x20 0.60		22x35 0.60	25.4x30 0.62	30x20 0.60		22x40 0.47	25.4x30 0.46	30x25 0.47	35x20 0.48
120	22x30 0.62	25.4x25 0.64	30x20 0.65		22x40 0.69	25.4x30 0.68	30x25 0.70	35x20 0.71	22x45 0.53	25.4x35 0.53	30x30 0.55	35x25 0.56
150	22x40 0.78	25.4x30 0.76	30x25 0.78	35x20 0.80	22x45 0.81	25.4x35 0.81	30x30 0.83	35x20 0.80	22x50 0.62	25.4x40 0.62	30x30 0.61	35x25 0.62
180	22x45 0.89	25.4x35 0.88	30x30 0.91	35x20 0.87	22x50 0.93	25.4x40 0.93	30x30 0.91	35x25 0.93		25.4x45 0.71	30x35 0.70	35x30 0.78
220	22x50 1.03	25.4x40 1.03	30x30 1.00	35x25 1.03		25.4x45 1.07	30x35 1.06	35x30 1.08		25.4x50 0.82	30x40 0.82	35x30 0.80
270		25.4x45 1.19	30x35 1.17	35x30 1.20		25.4x50 1.24	30x40 1.23	35x30 1.20			30x45 0.95	35x35 0.93
330			30x40 1.36	35x35 1.40			30x45 1.42	35x35 1.40			30x50 1.09	35x40 1.08
390			30x45 1.54	35x40 1.59			30x50 1.61	35x40 1.59				35x45 1.22
470				35x45 1.82				35x45 1.82				35x50 1.39
560				35x50 2.06				35x35 2.06				

← 外壳尺寸 Case Size ∅D x L(mm)
← 纹波电流 R.C (A rms) 在 105°C, 120Hz

鋁電解電容器

Aluminum Electrolytic Capacitor

LSS 系列

- 螺栓形接线端子. Screw Type.
- 高可靠性, 高纹波电流.
High Reliability, High Ripple Current.
- 85°C, 耐久性 3,000 小时.
85°C, Load Life: 3,000 Hours.



项目 Item	特性 Specifications																																																																			
额定工作电压 Rated Voltage Range	10 ~ 450 VDC																																																																			
工作温度范围 Temperature Range	-40 ~ +85°C (10 ~ 250V) -25 ~ +85°C (350 ~ 450V)																																																																			
容量允许误差 Capacitance Tolerance	± 20% (M) (在 20°C, 120 Hz)																																																																			
最大泄漏电流 Leakage Current	5 分钟后, $3\sqrt{CV}$ (µA) 或 5mA, 取较小值. (C: 标准电容量, V: 额定电压) (在 20°C) After 5 minutes, $3\sqrt{CV}$ (µA) or 5mA, whichever is smaller.																																																																			
最大损失角正切 Dissipation Factor (tan δ) (在 20°C, 120 Hz)	<table border="1"> <thead> <tr> <th>∅D \ V</th> <th>10</th> <th>16</th> <th>25</th> <th>35</th> <th>50</th> <th>63</th> <th>80</th> <th>100</th> <th>160~250</th> <th>315~450</th> </tr> </thead> <tbody> <tr> <td>35</td> <td>0.75</td> <td>0.60</td> <td>0.40</td> <td>0.30</td> <td>0.25</td> <td>0.20</td> <td>0.20</td> <td>0.15</td> <td>0.15</td> <td>0.20</td> </tr> <tr> <td>51</td> <td>1.00</td> <td>0.70</td> <td>0.50</td> <td>0.50</td> <td>0.30</td> <td>0.25</td> <td>0.20</td> <td>0.20</td> <td>0.15</td> <td>0.20</td> </tr> <tr> <td>63.5</td> <td>1.30</td> <td>0.80</td> <td>0.70</td> <td>0.60</td> <td>0.50</td> <td>0.30</td> <td>0.25</td> <td>0.25</td> <td>0.20</td> <td>0.25</td> </tr> <tr> <td>76</td> <td>1.50</td> <td>1.00</td> <td>0.80</td> <td>0.70</td> <td>0.60</td> <td>0.40</td> <td>0.30</td> <td>0.25</td> <td>0.20</td> <td>0.25</td> </tr> <tr> <td>89</td> <td>1.50</td> <td>1.00</td> <td>0.80</td> <td>0.70</td> <td>0.60</td> <td>0.40</td> <td>0.30</td> <td>0.25</td> <td>0.20</td> <td>0.25</td> </tr> </tbody> </table>		∅D \ V	10	16	25	35	50	63	80	100	160~250	315~450	35	0.75	0.60	0.40	0.30	0.25	0.20	0.20	0.15	0.15	0.20	51	1.00	0.70	0.50	0.50	0.30	0.25	0.20	0.20	0.15	0.20	63.5	1.30	0.80	0.70	0.60	0.50	0.30	0.25	0.25	0.20	0.25	76	1.50	1.00	0.80	0.70	0.60	0.40	0.30	0.25	0.20	0.25	89	1.50	1.00	0.80	0.70	0.60	0.40	0.30	0.25	0.20	0.25
∅D \ V	10	16	25	35	50	63	80	100	160~250	315~450																																																										
35	0.75	0.60	0.40	0.30	0.25	0.20	0.20	0.15	0.15	0.20																																																										
51	1.00	0.70	0.50	0.50	0.30	0.25	0.20	0.20	0.15	0.20																																																										
63.5	1.30	0.80	0.70	0.60	0.50	0.30	0.25	0.25	0.20	0.25																																																										
76	1.50	1.00	0.80	0.70	0.60	0.40	0.30	0.25	0.20	0.25																																																										
89	1.50	1.00	0.80	0.70	0.60	0.40	0.30	0.25	0.20	0.25																																																										
耐久性 Load Life	电容器在 85°C 环境中施加额定电压连续 3,000 小时后, 冷却至 20°C 测量, 特性应满足: The following specifications shall be satisfied when the capacitors are restored to 20°C after the rated voltage is applied for 3,000 hours at 85°C	<table border="1"> <tbody> <tr> <td>容量变化 Capacitance Change</td> <td>± 150%以内 ≤ ± 150% of the initial value</td> </tr> <tr> <td>损失角(tan δ) D.F</td> <td>小于初始规定值的 175% ≤ 175% of the initial specified value</td> </tr> <tr> <td>泄漏电流 Leakage Current</td> <td>小于初始规定值 ≤ the initial specified value</td> </tr> </tbody> </table>	容量变化 Capacitance Change	± 150%以内 ≤ ± 150% of the initial value	损失角(tan δ) D.F	小于初始规定值的 175% ≤ 175% of the initial specified value	泄漏电流 Leakage Current	小于初始规定值 ≤ the initial specified value																																																												
容量变化 Capacitance Change	± 150%以内 ≤ ± 150% of the initial value																																																																			
损失角(tan δ) D.F	小于初始规定值的 175% ≤ 175% of the initial specified value																																																																			
泄漏电流 Leakage Current	小于初始规定值 ≤ the initial specified value																																																																			
储存性 Shelf Life	未加电压的电容器放置在 85°C 环境中连续 500 小时, 然后冷却至 20°C 测量, 特性应满足耐久性规定。 When the capacitors are restored to 20°C after exposing them at 85°C for 500 hours without voltage applied, the specifications shall satisfy the specifications of the load life.																																																																			
其它 Others	满足 JIS C5141 之 W 项规定. Satisfies characteristic W of JIS C5141.																																																																			

图形和尺寸 Figure and Dimensions

单位 Unit: mm

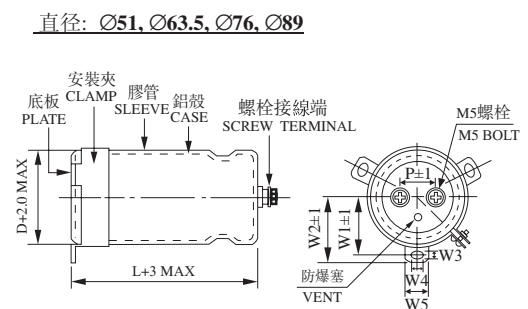
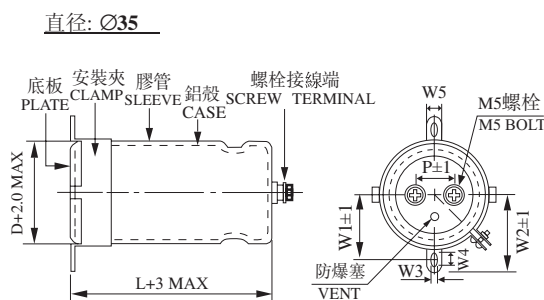

∅D	W1	W2	W3	W4	W5	P
35	24.0	29.0	3.5	6	10	12.7
51	32.5	37.0	4.5	8	14	21.8
63.5	38.0	43.5	4.5	8	14	28.2
76	44.5	50.0	4.5	8	14	31.4
89	50.8	56.5	4.5	8	16	31.4

螺栓规格 Bolt Specification:

1. 六角螺栓 Bolt: M5x0.8x10
2. 最大扭矩 MAX Torque: 33Kg.cm(3.23N.m)

纹波电流补偿系数 Multiplying Factor of Ripple Current

温度系数 Temperature Factor

环境温度(°C) Temperature	85	70	60 及以下
温度系数 Factor	1.00	1.60	1.80

频率系数 Frequency Factor

电压 (V) Voltage	频率 Frequency (Hz)				
	60	120	400	1K	10K
10 ~ 50	0.80	1.00	1.03	1.05	1.08
63 ~ 100	0.80	1.00	1.05	1.07	1.10
160 ~ 450	0.80	1.00	1.10	1.13	1.18

鋁電解電容器

Aluminum Electrolytic Capacitor

LSS 系列

外壳尺寸和最大纹波电流 Case Size and Rated Ripple Current

V μF	10		16		25		35		50		63		80		
3,300													35×50	2.5	
3,900													35×50	2.6	
4,700													35×50	2.8	
5,600												35×50	3.0	35×60	2.9
6,800									35×50	3.3	35×50	3.2	35×80	3.7	
8,200									35×50	3.7	35×60	3.8	35×80	4.2	
10,000								35×50	3.6	35×50	4.3	35×80	4.1	35×100	5.0
12,000								35×50	3.7	35×60	5.3	35×80	4.4	35×120	5.4
15,000								35×50	4.0	35×80	5.5	35×100	5.5	51×80	7.7
18,000					35×50	5.0	35×60	4.7	35×80	5.7	35×120	6.2	51×80	7.8	
22,000					35×60	5.4	35×80	5.6	35×100	6.1	51×80	7.1	51×80	8.0	
27,000			35×50	5.1	35×80	5.8	35×80	6.2	35×120	6.7	51×80	7.4	51×100	8.7	
33,000			35×60	5.5	35×80	6.0	35×80	6.3	51×80	7.1	51×100	8.8	51×120	10.5	
39,000	35×50	5.3	35×80	7.0	35×80	6.7	35×100	7.6	51×80	7.4	51×120	10.0	63.5×100	12.1	
47,000	35×60	6.0	35×80	7.3	35×100	8.0	35×120	8.7	51×100	8.7	63.5×100	11.9	63.5×100	14.4	
56,000	35×80	6.3	35×100	7.6	35×120	8.4	51×80	10.0	51×100	9.8	63.5×100	12.6	63.5×120	15.0	
68,000	35×80	7.9	35×100	10.3	51×80	9.3	51×80	10.8	51×120	12.0	63.5×120	15.0	63.5×140	16.8	
82,000	35×80	8.4	35×120	10.5	51×80	10.0	51×100	12.0	63.5×100	12.3	76×100	16.4	76×120	19.4	
100,000	35×120	9.3	51×80	10.9	51×100	12.0	51×120	13.6	63.5×120	14.2	76×120	18.9	76×140	21.5	
120,000	51×80	10.0	51×100	11.1	51×120	12.9	63.5×100	13.8	63.5×120	16.0	76×140	21.6	89×140	22.3	
150,000	51×80	11.0	51×100	12.6	63.5×100	15.3	63.5×100	14.6	76×120	18.6	89×140	26.0			
180,000	51×100	12.1	51×120	13.2	63.5×100	15.5	63.5×120	16.7	76×140	19.5					
220,000	51×100	14.0	63.5×100	14.7	63.5×120	18.0	76×100	17.4	89×140	23.3					
270,000	51×120	14.2	63.5×120	15.4	76×100	18.8	76×140	23.1	89×140	24.8					
330,000	63.5×100	17.3	63.5×140	18.3	76×120	23.2	76×150	25.9							
390,000	63.5×120	18.0	76×120	19.0	76×140	23.5	89×140	26.5							
470,000	63.5×140	19.3	76×140	22.0	89×140	24.7	89×150	28.3							
560,000	76×120	20.1	76×150	23.0	89×140	26.2									
680,000	76×140	24.0													

V μF	100		160		200		250		350		400		450		
270											35×50	1.3	35×50	1.6	
330											35×50	1.7	35×60	1.8	
390									35×50	1.9	35×60	1.8	35×80	2.2	
470								35×50	1.6	35×60	2.1	35×80	2.3	35×80	2.4
560								35×50	1.6	35×80	2.4	35×80	2.7	35×100	2.8
680					35×50	1.6	35×50	1.7	35×80	2.9	35×100	2.9	35×120	3.1	
820					35×50	1.7	35×60	1.8	35×100	3.4	35×100	3.4	51×80	3.5	
1,000					35×60	2.2	35×80	2.4	35×100	3.8	35×120	3.9	51×80	4.0	
1,200			35×50	2.3	35×60	2.3	35×80	2.4	35×120	4.2	51×80	4.2	51×100	4.8	
1,500			35×60	3.2	35×80	2.9	35×100	3.1	51×80	4.7	51×100	4.8	51×120	5.7	
1,800			35×80	3.4	35×80	2.9	35×120	3.4	51×100	6.3	51×100	5.7	63.5×100	6.5	
2,200	35×50	2.5	35×80	3.6	35×100	3.6	51×80	3.9	51×100	6.4	51×120	7.0	63.5×100	7.2	
2,700	35×50	2.7	35×100	3.8	35×120	4.0	51×80	4.0	63.5×100	8.8	63.5×100	7.9	63.5×120	8.7	
3,300	35×50	3.2	35×120	4.7	51×80	4.6	51×100	5.4	63.5×100	8.8	63.5×120	9.5	76×120	10.5	
3,900	35×60	3.3	51×80	5.3	51×80	4.7	51×120	6.6	63.5×120	10.3	76×100	10.7	76×120	12.0	
4,700	35×80	3.5	51×80	5.6	51×100	7.1	63.5×100	7.3	76×100	12.0	76×120	12.8	76×140	13.3	
5,600	35×80	3.8	51×100	6.4	51×120	8.3	63.5×100	7.3	76×120	12.7	76×140	14.5	89×140	15.8	
6,800	35×100	4.5	51×100	7.5	63.5×100	9.5	63.5×120	8.9	76×140	16.0	76×150	17.5	89×150	18.7	
8,200	35×120	6.0	51×120	8.1	63.5×100	10.0	76×100	8.9	89×140	19.0	89×140	18.0			
10,000	35×120	6.3	63.5×100	9.9	63.5×120	11.1	76×120	11.8	89×140	20.0	89×150	20.5			
12,000	51×80	6.6	63.5×120	1.8	76×100	11.6	76×140	13.1							
15,000	51×80	8.5	76×100	12.7	76×120	12.9	89×140	16.5							
18,000	51×100	8.9	76×120	14.1	76×140	15.2									
22,000	51×120	10.2	76×140	16.6	89×140	15.6									
27,000	63.5×100	11.0	89×140	17.7											
33,000	63.5×120	11.7	89×140	18.9											
39,000	76×100	12.5													
47,000	76×120	14.5													
56,000	76×140	16.2													
68,000	76×150	18.3													
82,000	89×140	20.1													
100,000	89×140	21.0													

↑ ↑ 纹波电流 Ripple Current (A rms) 在 85°C, 120Hz
 外壳尺寸 Case Size ØD x L(mm)

鋁電解電容器

Aluminum Electrolytic Capacitor

LKS 系列

- 螺栓形接线端子. Screw Type.
- 高可靠性, 高纹波电流.
High Reliability, High Ripple Current.
- 105°C, 耐久性 2,000 小时.
105°C, Load Life: 2,000 Hours.



项目 Item	特性 Specifications																																																																														
额定工作电压 Rated Voltage Range	10 ~ 400 VDC																																																																														
工作温度范围 Temperature Range	-40 ~ +105°C (10 ~ 250V) -25 ~ +105°C (315 ~ 400V)																																																																														
容量允许误差 Capacitance Tolerance	± 20% (M) (在 20°C, 120 Hz)																																																																														
最大泄漏电流 Leakage Current	5 分钟后, $3\sqrt{CV}$ (μA) 或 5mA, 取较小值. (C: 标准电容量, V: 额定电压) (在 20°C) After 5 minutes, $3\sqrt{CV}$ (μA) or 5mA, whichever is smaller.																																																																														
最大损失角正切 Dissipation Factor (tan δ) (在 20°C, 120 Hz)	<table border="1"> <thead> <tr> <th>∅D \ V</th> <th>10</th> <th>16</th> <th>25</th> <th>35</th> <th>50</th> <th>63</th> <th>80</th> <th>100</th> <th>160~250</th> <th>315~400</th> </tr> </thead> <tbody> <tr> <td>35</td> <td>0.75</td> <td>0.60</td> <td>0.40</td> <td>0.30</td> <td>0.25</td> <td>0.20</td> <td>0.20</td> <td>0.15</td> <td>0.15</td> <td>0.20</td> </tr> <tr> <td>42</td> <td>0.85</td> <td>0.65</td> <td>0.40</td> <td>0.30</td> <td>0.30</td> <td>0.30</td> <td>0.25</td> <td>0.15</td> <td>0.15</td> <td>0.20</td> </tr> <tr> <td>51</td> <td>1.00</td> <td>0.70</td> <td>0.50</td> <td>0.50</td> <td>0.30</td> <td>0.25</td> <td>0.20</td> <td>0.20</td> <td>0.15</td> <td>0.20</td> </tr> <tr> <td>63.5</td> <td>1.30</td> <td>0.80</td> <td>0.70</td> <td>0.60</td> <td>0.50</td> <td>0.30</td> <td>0.25</td> <td>0.25</td> <td>0.20</td> <td>0.25</td> </tr> <tr> <td>76</td> <td>1.50</td> <td>1.00</td> <td>0.80</td> <td>0.70</td> <td>0.60</td> <td>0.40</td> <td>0.30</td> <td>0.25</td> <td>0.20</td> <td>0.25</td> </tr> <tr> <td>89</td> <td>1.50</td> <td>1.00</td> <td>0.80</td> <td>0.70</td> <td>0.60</td> <td>0.40</td> <td>0.30</td> <td>0.25</td> <td>0.20</td> <td>0.25</td> </tr> </tbody> </table>		∅D \ V	10	16	25	35	50	63	80	100	160~250	315~400	35	0.75	0.60	0.40	0.30	0.25	0.20	0.20	0.15	0.15	0.20	42	0.85	0.65	0.40	0.30	0.30	0.30	0.25	0.15	0.15	0.20	51	1.00	0.70	0.50	0.50	0.30	0.25	0.20	0.20	0.15	0.20	63.5	1.30	0.80	0.70	0.60	0.50	0.30	0.25	0.25	0.20	0.25	76	1.50	1.00	0.80	0.70	0.60	0.40	0.30	0.25	0.20	0.25	89	1.50	1.00	0.80	0.70	0.60	0.40	0.30	0.25	0.20	0.25
∅D \ V	10	16	25	35	50	63	80	100	160~250	315~400																																																																					
35	0.75	0.60	0.40	0.30	0.25	0.20	0.20	0.15	0.15	0.20																																																																					
42	0.85	0.65	0.40	0.30	0.30	0.30	0.25	0.15	0.15	0.20																																																																					
51	1.00	0.70	0.50	0.50	0.30	0.25	0.20	0.20	0.15	0.20																																																																					
63.5	1.30	0.80	0.70	0.60	0.50	0.30	0.25	0.25	0.20	0.25																																																																					
76	1.50	1.00	0.80	0.70	0.60	0.40	0.30	0.25	0.20	0.25																																																																					
89	1.50	1.00	0.80	0.70	0.60	0.40	0.30	0.25	0.20	0.25																																																																					
耐久性 Load Life	电容器在 105°C 环境中施加额定电压连续 2,000 小时后, 冷却至 20°C 测量, 特性应满足: The following specifications shall be satisfied when the capacitors are restored to 20°C after the rated voltage is applied for 2,000 hours at 105°C	<table border="1"> <tbody> <tr> <td>容量变化 Capacitance Change</td> <td>± 150%以内 ≤ ± 150% of the initial value</td> </tr> <tr> <td>损失角(tan δ) D.F</td> <td>小于初始规定值的 175% ≤ 175% of the initial specified value</td> </tr> <tr> <td>泄漏电流 Leakage Current</td> <td>小于初始规定值 ≤ the initial specified value</td> </tr> </tbody> </table>	容量变化 Capacitance Change	± 150%以内 ≤ ± 150% of the initial value	损失角(tan δ) D.F	小于初始规定值的 175% ≤ 175% of the initial specified value	泄漏电流 Leakage Current	小于初始规定值 ≤ the initial specified value																																																																							
容量变化 Capacitance Change	± 150%以内 ≤ ± 150% of the initial value																																																																														
损失角(tan δ) D.F	小于初始规定值的 175% ≤ 175% of the initial specified value																																																																														
泄漏电流 Leakage Current	小于初始规定值 ≤ the initial specified value																																																																														
储存性 Shelf Life	未加电压的电容器放置在 105°C 环境中连续 500 小时, 然后冷却至 20°C 测量, 特性应满足耐久性规定。 When the capacitors are restored to 20°C after exposing them at 105°C for 500 hours without voltage applied, the specifications shall satisfy the specifications of the load life.																																																																														
其它 Others	满足 JIS C5141 之 W 项规定. Satisfies characteristic W of JIS C5141.																																																																														

图形和尺寸 Figure and Dimensions

直径: ∅35, ∅42

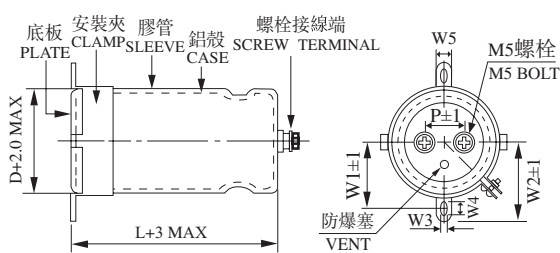

∅D	W1	W2	W3	W4	W5	P
35	24.0	29.0	3.5	6	10	12.7
42	27.5	32.5	3.5	6	10	14.7
51	32.5	37.0	4.5	8	14	21.8
63.5	38.0	43.5	4.5	8	14	28.2
76	44.5	50.0	4.5	8	14	31.4
89	50.8	56.5	4.5	8	16	31.4

纹波电流补偿系数 Multiplying Factor of Ripple Current

温度系数 Temperature Factor

环境温度(°C) Temperature	105	85	70 及以下
温度系数 Factor	1.00	1.70	2.00

频率系数 Frequency Factor

电压 (V) Voltage	频率 Frequency(Hz)				
	60	120	400	1K	10K
10 ~ 50	0.80	1.00	1.03	1.05	1.08
63 ~ 100	0.80	1.00	1.05	1.07	1.10
160 ~ 450	0.80	1.00	1.10	1.13	1.18

单位 Unit: mm

直径: ∅51, ∅63.5, ∅76, ∅89

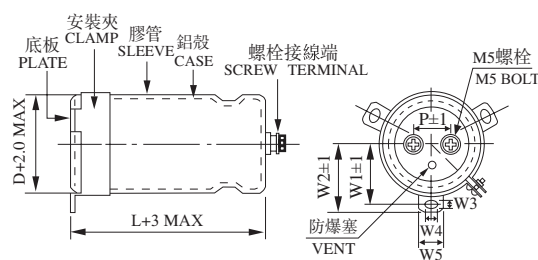

螺栓规格 Bolt Specification:

1. 六角螺栓 Bolt: M5x0.8x10
2. 最大扭矩 MAX Torque: 33Kg.cm(3.23N.m)



鋁電解電容器 Aluminum Electrolytic Capacitor

LKS 系列

外壳尺寸和最大纹波电流 Case Size and Rated Ripple Current

V μF	10		16		25		35		50		63		80		
3,300													35×50	3.0	
3,900													35×60	3.3	
4,700												35×50	3.2	35×80	3.6
5,600												35×60	3.5	35×80	3.9
6,800							35×50	2.5	35×50	3.6	35×60	3.8	35×80	4.3	
8,200							35×50	2.8	35×60	3.9	35×80	4.3	35×100	5.1	
10,000							35×50	3.8	35×80	4.2	35×80	4.7	35×120	5.8	
12,000							35×60	4.3	35×80	5.0	35×100	5.6	51×80	7.0	
15,000					35×50	4.2	35×80	4.7	35×100	5.5	35×120	6.4	51×80	7.6	
18,000					35×60	4.6	35×80	5.1	35×100	5.7	51×80	7.5	51×100	7.7	
22,000			35×50	4.0	35×80	5.2	35×100	5.6	35×120	7.5	51×80	7.5	51×120	9.0	
27,000	35×50	4.4	35×60	5.0	35×80	5.4	35×120	6.7	51×80	7.5	51×100	8.7	63.5×100	10.1	
33,000	35×60	5.5	35×80	5.2	35×100	6.5	51×80	7.1	51×100	9.3	51×120	10.3	63.5×120	11.6	
39,000	35×60	6.0	35×80	5.8	35×100	7.5	51×80	8.4	51×100	9.4	63.5×100	11.2	63.5×140	13.5	
47,000	35×80	6.6	35×100	6.8	35×120	8.9	51×100	9.9	51×120	11.7	63.5×120	12.9	76×100	15.8	
56,000	35×80	7.5	35×100	6.9	51×80	10.0	51×100	10.3	63.5×100	12.4	63.5×140	15.2	76×120	17.0	
68,000	35×100	7.6	35×120	8.4	51×100	10.7	51×120	11.4	63.5×120	15.1	76×100	16.0	76×140	20.4	
82,000	35×120	9.0	51×83	8.4	51×100	12.0	63.5×100	12.5	76×100	15.5	76×120	17.7	76×150	21.5	
100,000	51×80	10.2	51×100	11.3	51×120	13.1	63.5×120	15.5	76×100	16.3	76×140	21.5	89×150	22.3	
120,000	51×80	11.0	51×100	11.4	63.5×100	13.7	76×100	15.5	76×120	19.1	89×140	22.4			
150,000	51×100	13.4	51×120	12.5	63.5×120	16.4	76×120	17.9	76×140	23.4					
180,000	51×120	14.0	63.5×100	14.2	76×100	16.7	76×140	20.0	89×140	23.7					
220,000	63.5×100	14.5	63.5×120	16.6	76×120	20.5	76×150	24.1							
270,000	63.5×120	16.0	76×100	17.5	76×140	21.3	89×140	26.5							
330,000	76×100	18.0	76×120	24.3	76×150	26.0									
390,000	76×100	19.5	76×140	25.2	89×140	27.2									
470,000	76×120	20.0	76×150	26.7											
560,000	76×140	24.1	89×140	29.1											
680,000	89×140	26.5													

V μF	100		160		200		250		315		350		400		
220											35×50	0.9	35×50	1.0	
270										35×50	1.0	35×50	1.0	35×60	1.0
330										35×60	1.2	35×60	1.2	35×60	1.2
390										35×60	1.3	35×80	1.3	35×80	1.4
470							35×50	1.3	35×80	1.5	35×80	1.5	35×100	1.5	
560					35×50	1.4	35×60	1.6	35×80	1.6	35×100	1.7	35×100	1.7	
680					35×50	1.5	35×80	1.7	35×100	1.9	35×100	1.9	51×80	2.3	
820			35×50	1.4	35×80	1.9	35×80	1.9	35×120	2.2	35×120	2.1	51×100	2.4	
1,000			35×60	1.9	35×80	2.2	35×100	2.3	51×80	2.3	51×100	2.5	51×120	2.7	
1,200			35×80	2.3	35×80	2.3	35×100	2.4	51×100	2.7	51×100	2.7	51×120	3.0	
1,500			35×80	2.6	35×100	2.9	35×120	2.9	51×100	3.1	51×120	3.3	63.5×100	3.5	
1,800			35×80	2.6	35×100	2.9	35×120	3.0	51×120	3.6	35.5×100	3.8	63.5×120	3.6	
2,200	35×50	2.9	35×100	3.2	35×120	3.3	51×100	3.8	63.5×100	4.2	35.5×120	4.6	76×100	4.1	
2,700	35×60	3.4	35×120	3.2	51×80	3.8	51×120	4.5	63.5×120	4.3	76×100	4.6	76×120	4.8	
3,300	35×80	3.9	35×120	3.7	51×100	4.7	63.5×100	5.2	76×100	4.9	76×120	5.3	76×140	5.7	
3,900	35×80	4.2	51×100	4.3	51×120	5.4	63.5×120	5.2	76×120	5.8	76×140	6.2	89×140	6.7	
4,700	35×80	4.6	51×100	4.8	63.5×100	6.2	63.5×120	5.7	76×120	6.3	89×140	7.4	89×140	7.4	
5,600	35×100	4.9	51×120	5.5	63.5×100	6.3	76×100	6.4	76×140	7.3	89×140	8.1			
6,800	35×120	5.5	63.5×100	6.3	63.5×120	7.3	76×120	7.6	89×140	8.9					
8,200	51×80	6.2	63.5×120	7.1	76×100	8.5	76×140	8.3							
10,000	51×100	6.7	76×100	7.9	76×120	9.5	89×140	9.9							
12,000	51×100	7.3	76×120	9.0	76×140	10.5	89×140	10.8							
15,000	51×120	8.6	76×140	11.3	89×140	12.5									
18,000	63.5×100	8.9	89×140	13.0	89×140	13.3									
22,000	63.5×120	10.3	89×140	14.3											
27,000	63.5×140	12.1													
33,000	76×120	14.1													
39,000	76×140	16.5													
47,000	76×140	18.3													
56,000	89×140	19.2													
68,000	89×150	20.1													

纹波电流 Ripple Current (A rms) 在 105°C, 120Hz
外壳尺寸 Case Size ØD x L(mm)

MANUFACTURING FLOW CHART

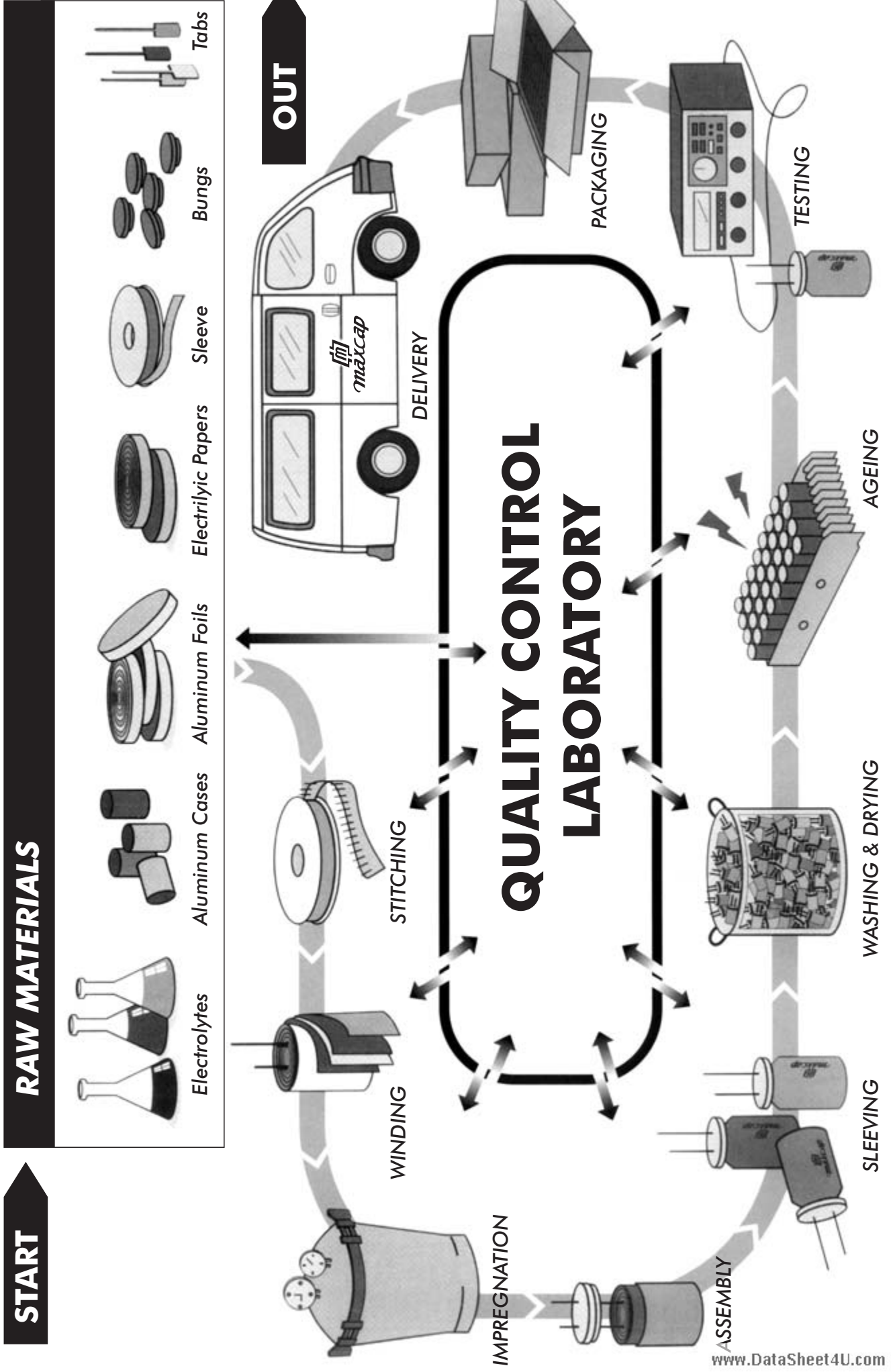

START

RAW MATERIALS

OUT



品管實驗室 QC Laboratory



X光檢查 X-Ray Inspection

品質是我們的信念。我們的哲學是優良的品質，值得信賴的服務，不斷改進的設計，永遠保持與客戶共同成長。

Quality is our byword. Our philosophy of excellent quality, dependable service, on-going innovation and designs keeps our customers with us year after year.



MAXCAP CORPORATION

MAXCAP (MALAYSIA) ELECTRONICS SDN.BHD.
No.7~9 Puncak Perusahaan 1
Kawasan Perindustrian Prai
13600 Prai, Penang Malaysia
Tel: (04) 3997193, Fax: (04) 3997046
E-mail: maxcap@tm.net.my

永茂電子(馬來西亞)有限公司
馬來西亞檳城州北賴工業區先鋒一路 7~9 號
電話:04-3997193
傳真:04-3997046
郵編:13600
E-mail: maxcap@tm.net.my

MAXCAP (CHINA) ELECTRONICS CO., LTD.
No.28 Huan Qing Road, Hi-Tech Industrial Park,
Kun Shan, Jiang Su, P.R.China.
Tel: (0512) 57786800, Fax: (0512) 57930596
PC: 215316
E-mail: maxcap@pub.sz.jsinfo.net

永茂電子(昆山)有限公司
江蘇省昆山市高科技工業園環慶路 28 號
電話: 0512 – 57786800 (0-2)
傳真: 0512 – 57930596
郵編: 215316
E-mail: maxcap@pub.sz.jsinfo.net