

Type No. E1L52-YC1A*-02	Drawn	<i>A. Kimura</i>
	Technical Div. I	<i>Koichi Ota</i>
	Admin. Div.	<i>K. Otake</i>

1. Product name                                    TG BLUISH-GREEN LED 5φ round

2. Absolute Maximum Ratings    ( $T_a=25^{\circ}\text{C}$ )

Fig.1

Item	Symbol	Value	Unit
Power Dissipation	$P_D$	120	mW
DC Forward Current	$I_F$	30	mA
DC Forward Current reduction (*1)	$\Delta I_F$	-0.40	mA/°C
Pulsed Forward Current (*2)	$I_{FP}$	100	mA
Reverse Voltage	$V_R$	5	V
Operating Temperature	$T_{opr}$	-30 ~ +80	°C
Storage Temperature	$T_{stg}$	-40 ~ +100	°C

(\*1)  $T_{opr} = 25 \sim 80^{\circ}\text{C}$  Use under this condition.

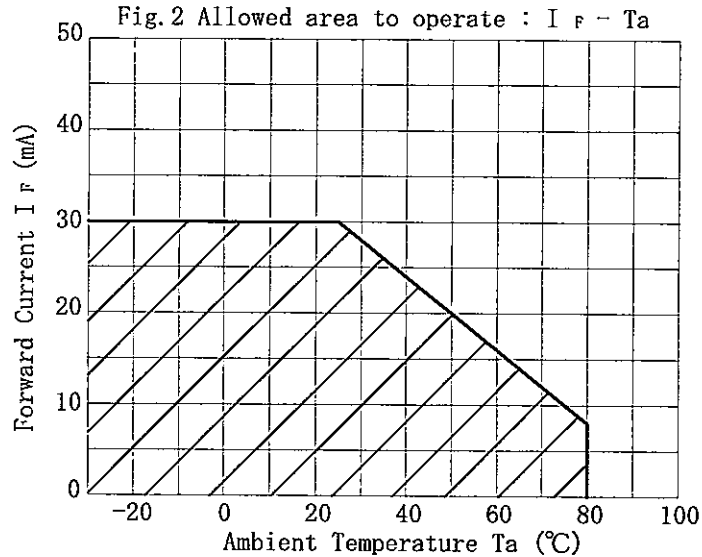

(\*2) Duty 1/10 Pulse Width 0.1 msec.

3. Electrical/Optical Characteristics ( $T_a=25\pm 3^\circ\text{C}$ )

Fig.3

Item	Symbol	Test Condition	Min.	Typ.	Max.	Unit
Forward Voltage	$V_F$	$I_F=10\text{mA}$	—	(3.2)	3.6	V
Reverse Current	$I_R$	$V_R=5\text{V}$	—	—	2	$\mu\text{A}$
Luminous Intensity (Axial Direction)	$I_V$	$I_F=10\text{mA}$	1195	(1790)	2680	mcd
Dominant Wavelength	$\lambda_D$	$I_F=10\text{mA}$	498	(503)	508	nm
Spectral Line Half Width	$\Delta\lambda$	$I_F=10\text{mA}$	—	(35)	—	nm
Color Coordinates	$\bar{x}$	$I_F=10\text{mA}$	—	(0.10)	—	—
	$\bar{y}$	$I_F=10\text{mA}$	—	(0.53)	—	—
Purity of Color	Pe	$I_F=10\text{mA}$	40	—	—	%

Fig.4 Following Ranking is applied. ( $I_F=10\text{mA}$ )

Rank		Luminous Intensity (mcd) (*3)
Dominant wavelength (nm) (*4)		
498 ~ 503	503 ~ 508	
C	L	1195 ~ 1790
D	M	1790 ~ 2680

(\*3) Guaranteed value is 20% higher and/or lower than this value.

(ex. rank C 956 ~ 2148mcd)

(\*4) Guaranteed value is 2nm longer and/or shorter than this value.

(ex. rank C 496 ~ 505nm)

Type No. E1L52-YC1A\*-02

4. Outline Dimensions

Fig.5

Unit : mm

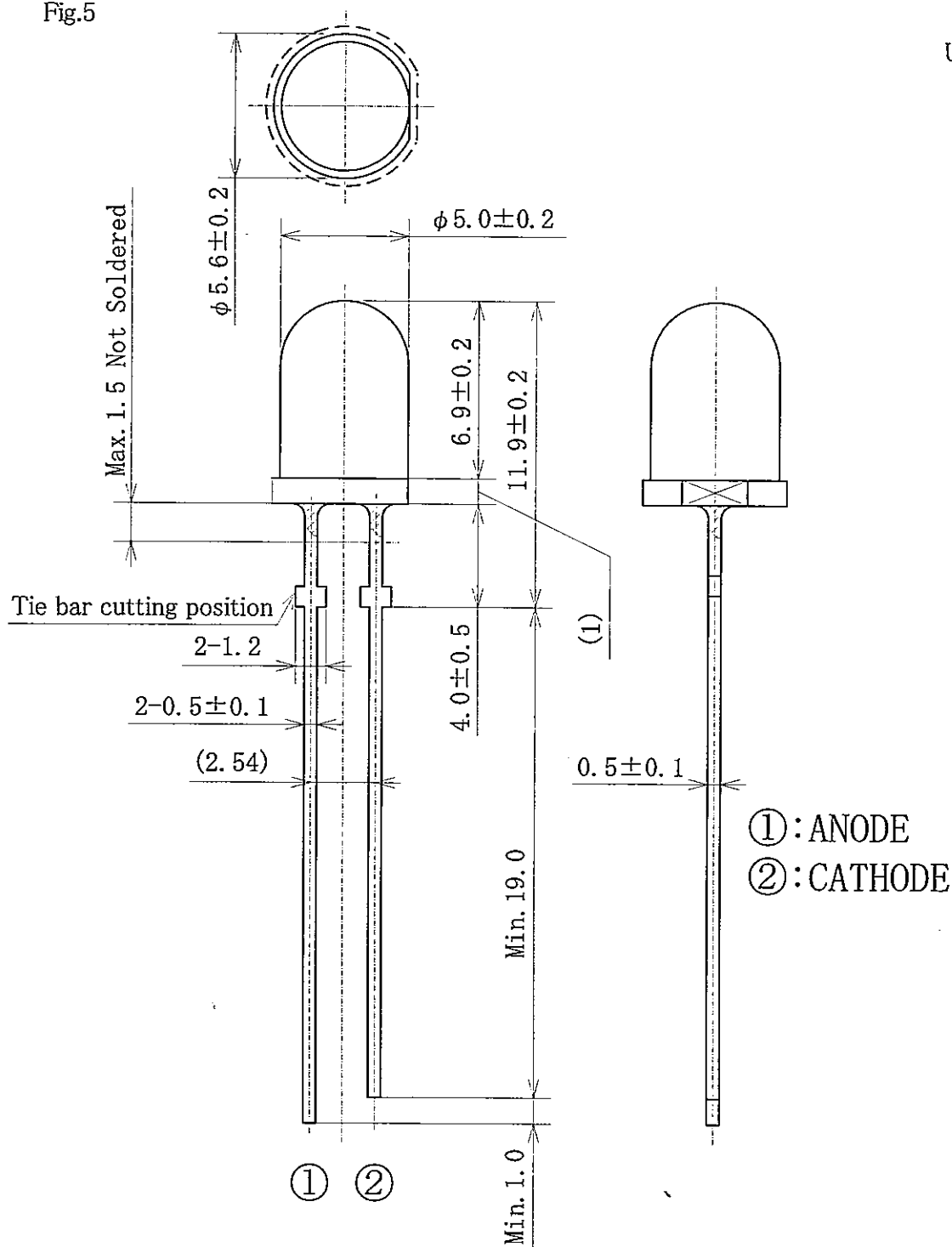

- General tolerance : ±0.3
- Lead Frame : Alloy Steel
- Lead surface : dip-soldered
- Lens : water clear

Type No. E1L52-YC1A\*-02

5. Reliability Tests

Fig.6

Item	Standard Test Method (*5)	Test Conditions	Failure Rate (*6,7)
Operating Test	ED-4701 D-511	$T_a = 25\text{ }^\circ\text{C}$ , $I_F = 30\text{ mA DC}$ , $t = 1000\text{ hrs.}$	0/20
High Temp. Operating Test	-	$T_a = 80\text{ }^\circ\text{C}$ , $I_F = 8\text{ mA DC}$ , $t = 1000\text{ hrs.}$	0/20
High Humidity Operating Test	ED-4701-3 B-122A	$T_a = 60^\circ\text{C}$ , $\text{RH} = 90\%$ , $I_F = 16\text{ mA DC}$ $t = 1000\text{ hrs.}$	0/20
High Temp. Storage Test	ED-4701-3 B-111A	$T_a = 100\text{ }^\circ\text{C}$ , $t = 1000\text{ hrs.}$	0/20
Low Temp. Storage Test	ED-4701-3 B-112A	$T_a = -40\text{ }^\circ\text{C}$ , $t = 1000\text{ hrs.}$	0/20
High Humidity Storage Test	ED-4701-3 B-121A	$T_a = 85^\circ\text{C}$ , $\text{RH} = 85\%$ , $t = 1000\text{ hrs.}$	0/20
Temperature Cycle Test	ED-4701-3 B-131A	$T_a = (-40\text{ }^\circ\text{C}, 30\text{ min.} \sim 25\text{ }^\circ\text{C}, 5\text{ min.}$ $\sim 100\text{ }^\circ\text{C}, 30\text{ min.} \sim 25\text{ }^\circ\text{C}, 5\text{ min.}) \times 100\text{ cy.}$	0/20
Thermal shock Test	ED-4701-3 B-141A	$T_a = (100\text{ }^\circ\text{C}, 5\text{ min.} \sim -40^\circ\text{C}, 5\text{ min.}) \times 50\text{ cy.}$	0/20
Soldering Heat Test	ED-4701 A-132	$T_a = 260\text{ }^\circ\text{C}$ , $t = 5\text{ sec.}$ , 2 times	0/20
Fall Test	-	$h = 1\text{m}$ , maple tree board, 10times No broken	0/20
Terminal Strength Test	ED-4701-3 A-111A	(Tensile) $W = 4.9\text{N}$ , $t = 30\text{sec.}$ No broken & No looseness	0/20
Terminal Strength Test	ED-4701-3 A-111A	(Bending) $W = 2.5\text{N}$ , 2times No broken & No looseness	0/20

(\*5) Number : EIAJ ("Electronic Industries Association of Japan") standard methods are used.

(\*6) Failure rate above is obtained when there is no damage by static electricity.

(\*7) Failure rate evaluated based on following "Criteria for Judging the Damage"

Fig.7

Criteria for Judging the Damage

Item	Symbol	Test Condition	Limit	
			Min.	Max.
Forward Voltage	$V_F$	$I_F = 10\text{ mA}$	-	U.S.L. $\times 1.2$
Reverse Current	$I_R$	$V_R = 5\text{ V}$	-	U.S.L. $\times 2.0$
Luminous Intensity	$I_V$	$I_F = 10\text{ mA}$	L.S.L. $\times 0.5$	-

(\*8) U.S.L. : Upper Standard Level (Max. of Value of Fig.3 (See P.2))

(\*9) L.S.L. : Lower Standard Level (Min. of Value of Fig.3 (See P.2))

6. Typical Characteristics

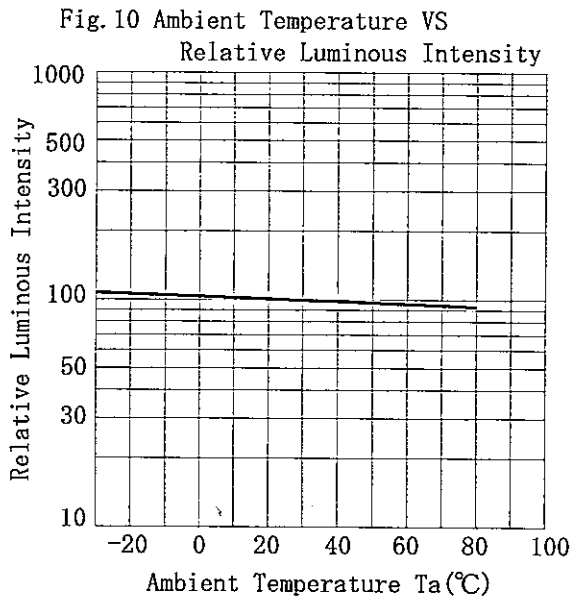
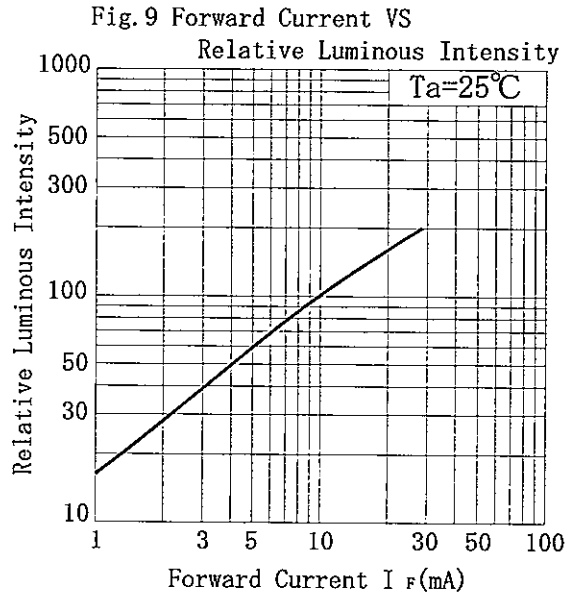
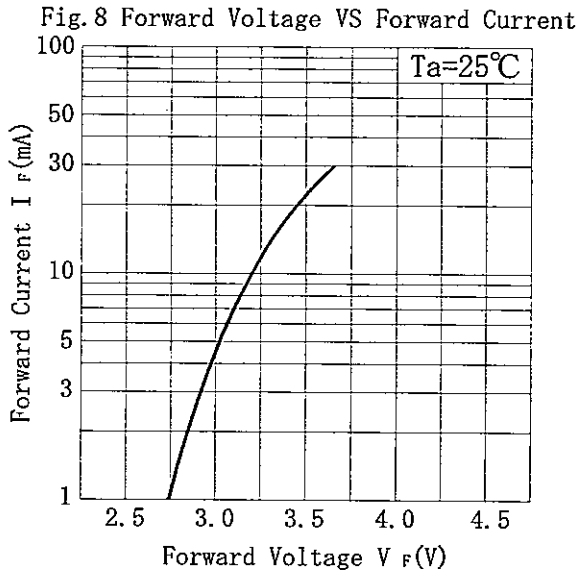

Fig. 11 Spectrum

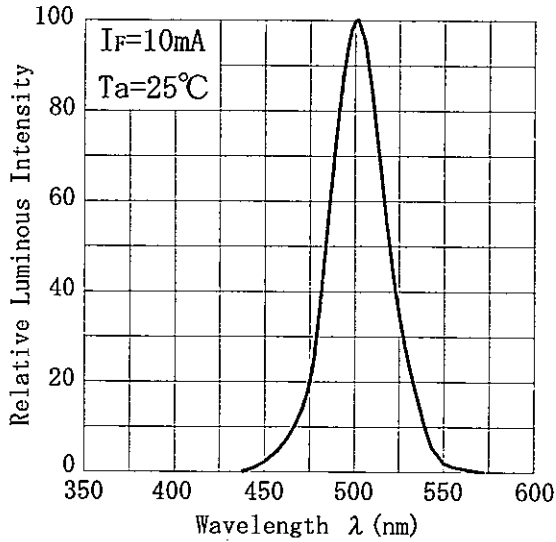

Fig. 12 Forward Current VS Dominant Wavelength

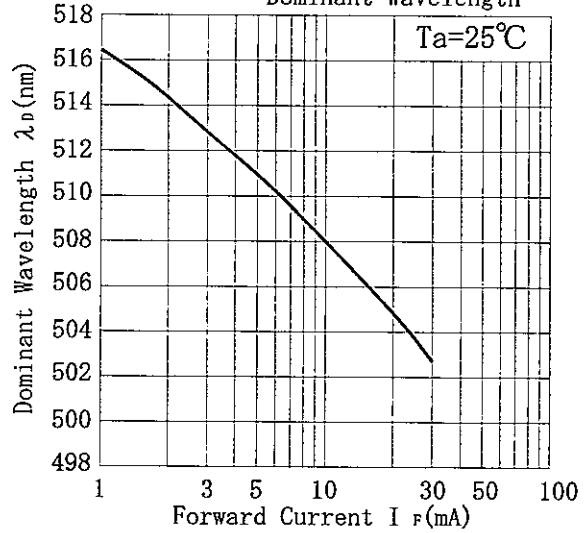

Fig. 13 Forward Current VS Chromaticity Diagram

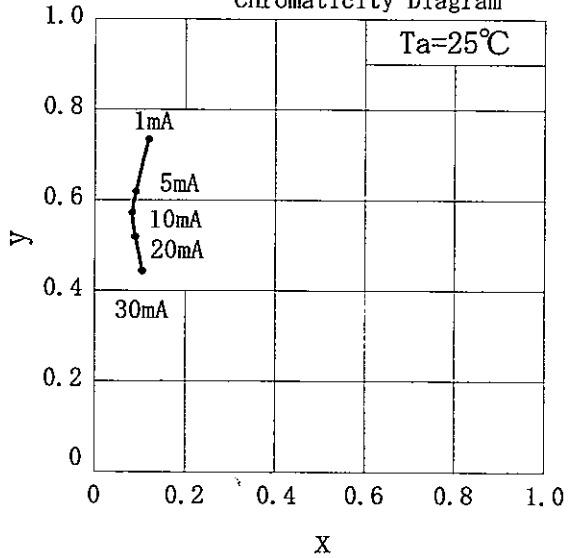
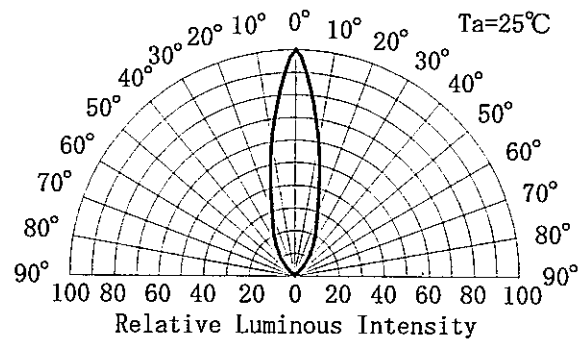

Fig. 14 Directive Characteristics



7. Code Formation

E 1 

L
---

5
---

2
---

 - 

Y
---

C
---

1
---

A
---

2
---

 - \* \* 

C
---

Rank Code

Package of Products

2	200 pieces (Bulk)
6	2000 pieces (Taped)

Color

C	Bluish-Green
---	--------------

Type

L	LED LAMP
---	----------

8. Shipping Package Style

(1) Bulk

200pcs are packed in ESD protected bag.

Bag Size : 150 mm × 203 mm

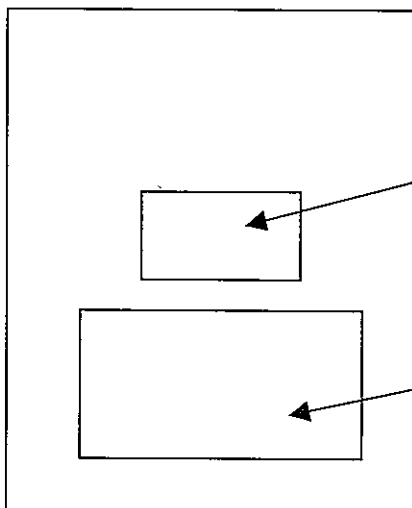

Label (Product Name, Product Number,  
Lot No. and Quantity are described)

Notice

Type No. E1L52-YC1A\*-02

(2) Taped

2000pcs are packed in ESD Protected box.

Package :

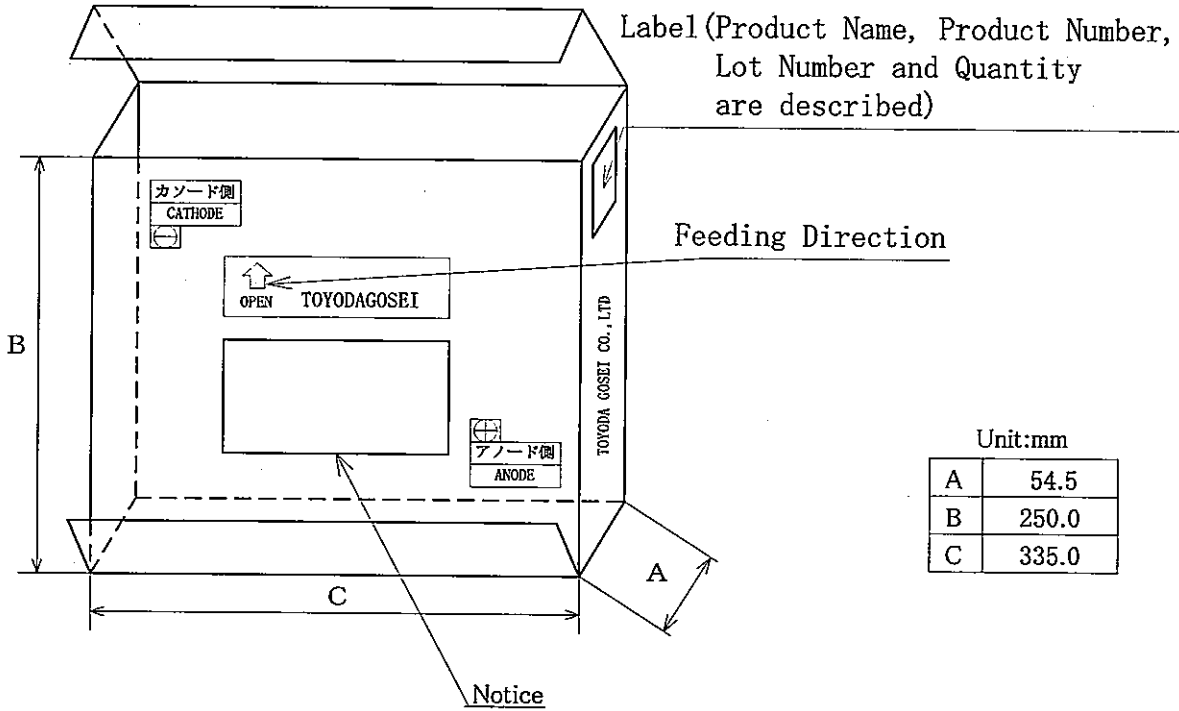

Label Formation

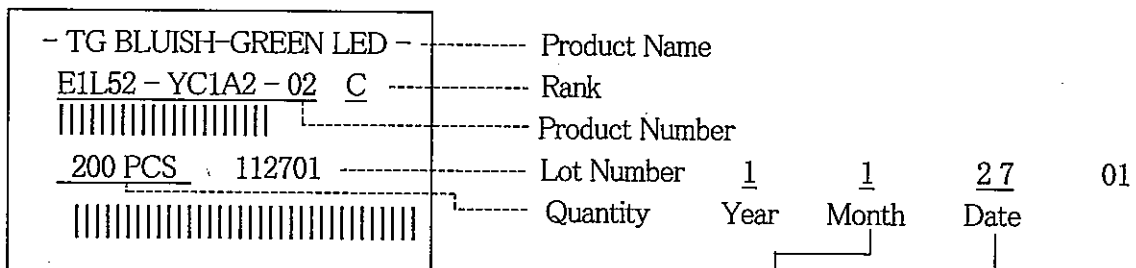

Jan. ~ Sep. : 1~9 32~39 means mixed Lot.  
 Oct. : O  
 Nov. : N  
 Dec. : D



Type No. E1L52-YC1A\*-02

Taping Dimensions

Unit:mm

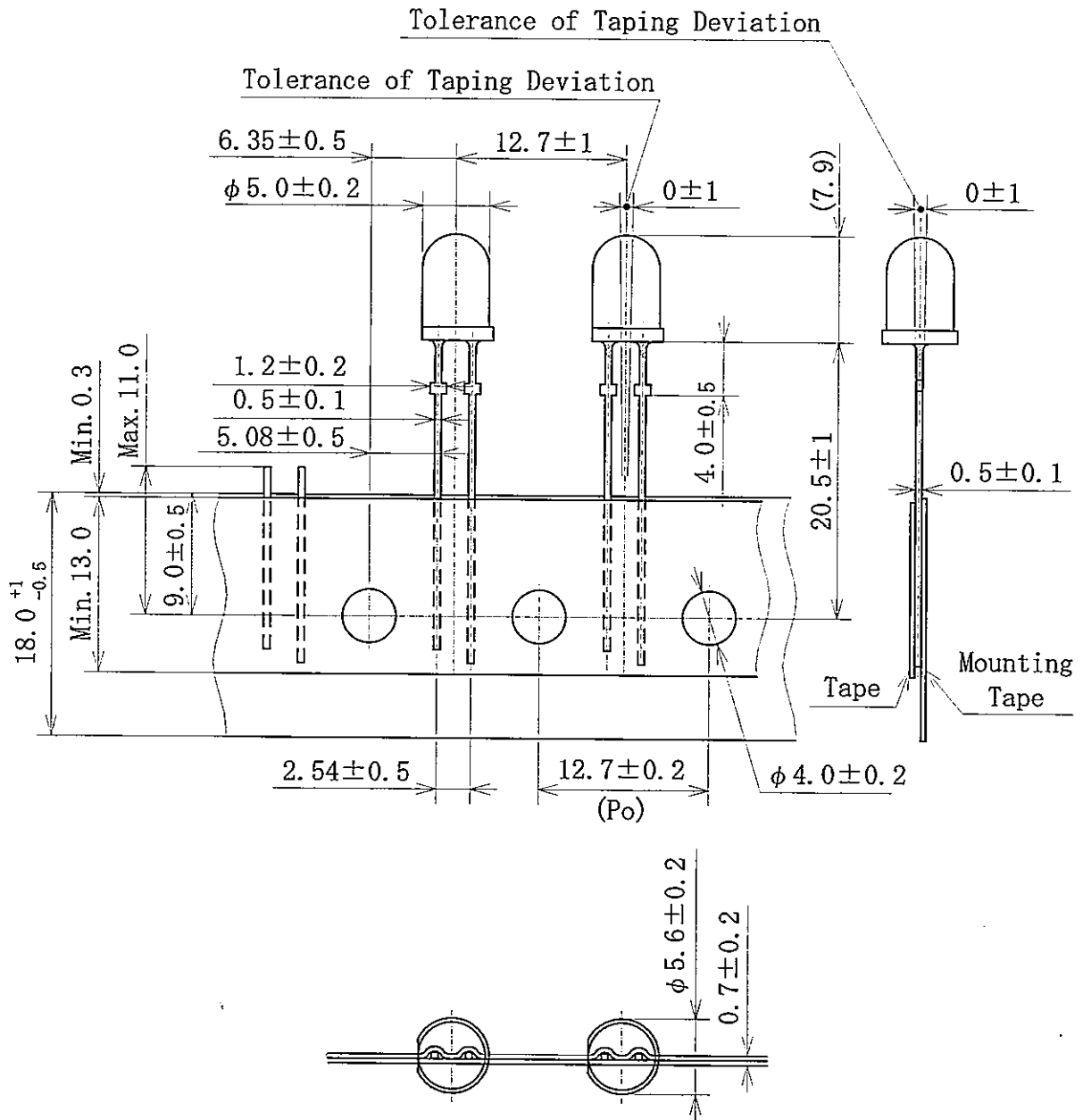

- 25 LEDs between folds.
- More than 2 pilot holes without LED on both ends of tape.
- Succession of insertion failure is less than 4.
- Cathode side of the first LED is marked with red line.
- Pitch tolerance level (Po) :  $\pm 1\text{mm}/20\text{pitch}$
- General tolerance :  $\pm 0.3$

## 9. PRECAUTIONS IN HANDLING

### (1) Safety Precautions

- Do not look directly at the LED with unshielded eyes, or damage to the retina may result.

### (2) Static Electricity

- These products are sensitive, a high standard of care must be used. Particularly if an over-current and over-voltage which exceeds the Absolute Maximum Rating of Products is applied, the overflow in energy may cause damage to, or possibly result in destruction of, the Products. Customer shall take absolutely secure countermeasures against static electricity and surge when handling Products.
- A protection device should be installed in the LED driving circuit, which does not exceed the max. rating for surge current during on/off switching.
- Proper grounding of Products (via 1 M $\Omega$ ), use of conductive mat, semiconductive working uniform and shoes, and semiconductive containers are considered to be effective as countermeasures against static electricity and surge.
- A soldering iron with a grounded tip is recommended. An ionizer should also be installed where risk of static generation is high.
- If the countermeasures mentioned above are implemented, LED can work well.  
Users are required to confirm those countermeasures when problems are caused by static electricity.

### (3) Soldering Condition

- When soldering, leave minimum clearance between the resin and the soldering point.
- Maximum allowable soldering conditions are:
  - Solder dipping : 260 degrees C max., 5seconds max., once.
  - Soldering iron : 350 degrees C max., 5seconds max., once, power 40 W max.
- Contact between molten solder and the resin must be avoided.
- Correcting the soldered position after soldering must be avoided.
- In soldering, do not apply any stress to the lead frame, particularly when heated.
- When other SMD parts in the same circuit board and adhesive is to be cured, maximum allowable conditions are:
  - 120 degrees C max., 60 seconds max.

### (4) Lead Forming and Cut

- Lead forming must be done below the tie bar cutting portion.
- When forming a lead, do not stress the resin case.
- Lead forming must be done before soldering.
- Cutting the lead frame at high temperature may result in personal injury. Cut the lead frame at room temperature.

(5) Assembly

- Do not apply any stress to the lead frame while assembling.
- When mounting Products onto boards such as printed wired board, the pitch between the two holes of such boards must match the pitch of the Products.

10.WARRANTY

- (1) Manufacturer only warrants that the Products will conform with the items and conditions described in paragraphs 2,3 and 4 in these Specifications.
- (2) Manufacturer's warranty as set forth in 10(1) above applies only when each Product stands alone. In no event shall Manufacturer assume responsibility for failure of injury arising out of Customer's installation or assembly of Products into Customer's equipment.
- (3) Customer shall conduct its receiving inspection promptly upon delivery, and in the event any Product units in the respective delivery are found not to conform with any of Manufacturer's warranties, Customer may reject and shall return such non-conforming units to Manufacturer for replacement. Customer shall provide the reason and the number for such rejection with the return of each non-conforming unit.
- (4) MANUFACTURER MAKES NO OTHER REPRESENTATION OR WARRANTIES, EITHER EXPRESS OR IMPLIED, CONCERNING THE PRODUCTS INCLUDING, WITHOUT LIMITATION, WARRANTIES OF MERCHANTABILITY OR FITNESS FOR A PARTICULAR PURPOSE.
- (5) Manufacturer's liability for nonconforming Products shall be in any case limited to replacement of nonconforming Products, provided that such nonconformity is attributable to Manufacturer. In no event shall Manufacturer be liable for any costs of expenses incurred for replacement of such nonconforming Products, consequential damages or lost profits.
- (6) The warranty for the Products shall be twelve (12) month from the date the Products are delivered to the Customer. Notwithstanding the foregoing, the warranty shall not apply to any of the following, even during such warranty period:
  - (a) failure of, or injury caused by the Products due to mishandling or misuse of the Products by Customer;
  - (b) failure of, or injury caused by the Products due to inappropriate repair or modification by Customer;
  - (c) failure of, or injury caused by Products due to force majeure including, without limitation, fire, earthquake, flood, lightning or other natural disasters, or pollution, damage from briny air or outbreak of a state of emergency; or
  - (d) Any failure and damage caused by not following the handling precautions listed in Section 9 of these Specifications.

- (7) The warranty provide for in these Specifications constitutes the entire and only agreement between Customer and Manufacturer with respect to the quality of the Products and supersedes, cancels and annuls all prior or contemporaneous negotiations or communications whether written or oral.
- (8) The warranty provided for in these Specifications can only be modified by a written agreement signed by the representatives of both Customer and Manufacturer.
- (9) IN NO EVENT SHALL MANUFACTURER BE LIABLE TO BUYER FOR ( I ) ANY LOSS OR DAMAGE (WHETHER SPECIAL, CONSEQUENTIAL, COMPENSATORY, PUNITIVE, EXEMPLARY, DIRECT, INDIRECT OR OTHERWISE) TO CUSTOMER'S PROPERTY RESULTING FROM THE USE, HANDLING, TRANSPORTATION, SALE, STORAGE, REPAIR, MODIFICATION OR MAINTENANCE OF THE PRODUCTS, WHETHER IN THE MANUFACTURING OR INSTALLATION PROCESS, ALONE, IN COMBINATION WITH OTHER GOODS, MATERIALS, EQUIPMENT OR SUBSTANCES OR OTHERWISE, (II) ANY LOSS OF USE, REVENUE OR PROFIT OR DIMINUTION OF GOODWILL, EVEN IF MANUFACTURER KNEW OR SHOULD HAVE KNOWN OF THE POSSIBILITY OF SUCH LOSS, DAMAGE OR DIMINUTION, (III) ANY INJURY TO OR DEATH OF PERSONS AND (IV) ANY CLAIM, DEMAND, ACTION, LAWSUIT OR OTHER PROCEEDING AGAINST CUSTOMER BY ANY THIRD PARTY, WITH RESPECT TO (A) ANY LOSS OR DAMAGE (WHETHER SPECIAL, CONSEQUENTIAL, COMPENSATORY, PUNITIVE, EXEMPLARY, DIRECT, INDIRECT OR OTHERWISE) INCURRED, SUFFERED OR OTHERWISE CLAIMED BY SUCH THIRD PARTY OR (B) ANY INJURY TO OR DEATH OF PERSONS.

## 11. MISCELLANEOUS

- (1) The Products described in these Specifications are intended only for standard applications or general electronic equipment such as office equipment, communications, electronic instrumentation and household electrical appliances.

When they are used for transport equipment, disaster prevention and crime prevention equipment as well as other safety devices calling for high reliability and safety, Customers are requested to pay particular heed to the safety design of the equipment as a whole in terms of fail-safe design and redundant design to maintain the reliability safety of such equipment.

Do not use them for special applications (and such as aviation, space craft and life-sustaining equipment) which require exceptionally high reliability and safety, and if their failure or malfunction may threaten human lives or may detrimental to human bodies.

It is to be understood that the manufacturer shall not be held responsible for any damage incurred as a result of using the product for purpose which is not the standard the manufacturer has intended to be used for, unless the manufacturer articulate agrees to the no-standard use in writing.

- (2) Customers must comply with the laws and public regulations concerning safety.

Type No. E1L52-YC1A\*-02

The content of these Specifications shall be deemed fully accepted by Customer either (1) upon execution hereof by the Customer or (2) if Customer does not advise Manufacture of any objections within two (2) weeks of the date of receipt of these Specifications, whichever is the earlier. If Customer does advise Manufacturer of any objections within two (2) weeks of the date of receipt of these Specifications, the parties shall negotiate an alternative acceptable to both parties, which alternative shall be deemed fully acceptable by Customer upon Customer's execution of the revised Specifications.

("Customer")

\_\_\_\_\_  
\_\_\_\_\_

Date \_\_\_\_\_

("Manufacture")

\_\_\_\_\_  
\_\_\_\_\_

Date \_\_\_\_\_

\_\_\_\_\_  
\_\_\_\_\_

Date \_\_\_\_\_