

Vorläufige technische Daten · Tentative data



Zuverlässigkeit

Der P-Faktor gibt den voraussichtlichen Röhrenausfall in Promille je 1000 Std. an. Er liegt bei ca. 1,5‰ je 1000 Std.

Reliability

The factor P indicates how many of 1,000 tubes fail over an operating period of 1,000 hours. The figure is approx. 1.5‰ for each 1,000 hours.



Lange Lebensdauer

Für diese Röhre wird eine Lebensdauer von 10000 Std., gemittelt über 100 Röhren, garantiert.

Long life

For long-life tubes we guarantee 10,000 hours operation, averaged over 100 tubes.



Enge Toleranzen

Bei dieser Röhre sind Streuungen der elektrischen Werte gegenüber Rundfunkröhren eingeengt.

Tight tolerances

In these tubes the tolerances of electrical ratings are reduced in comparison with receiving tubes.



Stoß- und Vibrationsfestigkeit

Die Röhre kann Schwingungen bis 2,5 g bei 50 Hz längere Zeit sowie Stoßbeschleunigungen bis 500 g kurzzeitig betriebssicher aufnehmen.

Vibration and shock proof

The tube withstands accelerations of 2.5 g at 50 c/s for lengthy periods and momentary shocks of 500 g for short periods.



Zwischenschichtfreie Spezialekathode

Die Spezialekathode dieser Röhre schließt das Entstehen einer störenden Zwischenschicht selbst dann aus, wenn sie längere Zeit bei eingeschalteter Heizung ohne Stromentnahme betrieben wird.

Cathode free from interface

The cathode establishes no interface even in cases where the heated tube is operated without plate current over lengthy periods.

$U_f^1)$	6,3 ± 5%	V
I_f	1,2 ± 0,08	A

Meßwerte · Measuring values

1) Als Pentode · As pentode

U_a	100	V
U_{g2}	100	V
R_k	75	Ω
I_a	100⁺¹⁸₋₁₅	mA
I_{g2}	5,2^{+1,3}_{-1,2}	mA
S	14 ± 2,5	mA/V
$R_{g2/g1}$	5,6	
R_i	5	k Ω
$-I_{g1}$	≤ 1	μ A
R_{iL}	100	Ω
I_a bei $U_{g1} = -35$ V	0,1	mA
$-U_{g1}^2)$	< 120	V
bei $I_k = 60$ μ A		
$U_{asp} = 7$ kV		
$U_{g2} = 190$ V		
$Z_{g1} \leq 1$ k Ω		

2) Als Triode geschaltet · Connected as triode

U_{ag2}	100	V
R_k	85	Ω
I_{a+g2}	100	mA
S	14	mA/V
μ	5,2	
R_i	350	Ω
R_{iL}	360	Ω

1) Die garantierte Lebensdauer gilt nur, wenn die Heizspannung in den Grenzen von ± 5% gehalten wird (absolute Grenzen).
The guaranteed life applies only if the filament voltage is kept in the limits ± 5% (absolute limits).

2) Endröhre für Horizontal-Ablenkung: Impulsdauer max. 22% einer Periode, max. 18 μ s.
Output tube for horizontal deflection: Pulse duration max. 22% per period, max. 18 μ s.



Ende der Lebensdauer, siehe „Meßwerte“ 1)

Anodenstrom	I_a	vom Anfangswert auf 65 mA	gesunken
Steilheit	S	vom Anfangswert auf 9,5 mA/V	gesunken
Negativer Gitterstrom	$-I_g$	vom Anfangswert auf 2 μ A	gestiegen

End of the life, see "Measuring values" 1)

Plate current	I_a	reduced from initial value to 65 mA
Mutual conductance	S	reduced from initial value to 9.5 mA/V
Negative grid current	$-I_g$	increased from initial value to 2 μ A

Isolationswiderstände · Insulation resistancebei $U_f = 6,3$ V

$U_{isol} = 300$ V	Anode gegen alle restlichen Elektroden anode towards remaining electrodes	> 1000	M Ω
$U_{isol} = 300$ V	Gitter 1 gegen alle restlichen Elektroden grid 1 towards remaining electrodes	> 100	M Ω
$U_{f/k} = 100$ V	Faden gegen Kathode filament towards cathode	> 5	M Ω

Betriebswerte · Typical operation**Optimale Spitzenwerte des Anodenstromes bei Anwendung als Zeilenendröhre.**

Die Kennlinien geben die Werte mittlerer neuer Röhren an. Beim Entwurf der Schaltung für die horizontale Ablenkung ist zu beachten, daß sich infolge Röhrentoleranzen und Veränderungen während der Lebensdauer die angegebenen Werte um 25 % verringern können.

In allen Schaltungen für die horizontale Ablenkung ist $R_{g2} \geq 1,5$ k Ω zu wählen. Beim Betrieb der Röhre unterhalb des Knies sollte zum Vermeiden von Barkhausen-Schwingungen der Schirmgitter-Widerstand nicht kleiner als 2,2 k Ω gewählt werden.

Optimal values of peak plate current when used as power tube for horizontal deflection.

Average values of new tubes are indicated by the curves. When developing new circuits for horizontal deflection it is necessary to note that the indicated values, caused by a changing and by tolerances of tubes, may decrease during the life time by 25 %.

For all circuits for horizontal deflection select $R_{g2} \geq 1.5$ k Ω . When driving the tube below the knee of anode current vs anode voltage characteristic a higher value for R_{g2} than 2.2 k Ω should be chosen to avoid Barkhausen-Kurz-oscillations.



Betriebswerte · Typical operation

2 Röhren in Gegentakt-B-Betrieb, Dauerton-Aussteuerung

2 tubes push-pull, class B, permanent tone level

U_a	250		V
U_{g2}	170		V
$R_{g2}^{1)}$	2 x 0,5		k Ω
$-U_{g1}$	34		V
I_a	2 x 12	2 x 94	mA
I_{g2}	2 x 1	2 x 14	mA
R_{aa}		3	k Ω
$U_{g1\text{eff}}$	0	22	V
N	0	30	W
k		6	%

1) Kapazitive Überbrückung führt zu Überlastung des Schirmgitters und ist deshalb nicht zulässig.
Capacitive shunting overloads the screen grid and is therefore inadmissible.

Absolute Grenzdaten

Absolute maximum ratings

U_{a0}	650	V
U_a	400	V
$U_{asp}^{1)}$	7	kV
$-U_{asp}^{1)}$	1,5	kV
N_a	20	W
$N_a + N_{g2}$	22	W
U_{g20}	650	V
U_{g2}	300	V
$N_{g2}^{2)}$	5,5	W
$-U_{g1sp}^{1)}$	1	kV
I_k	220	mA
$I_{ksp}^{4)}$	1,2	A
t_{av}	10	ms
$R_{g1}^{3)}$	0,5	M Ω
$U_{f/k}$	250	V
$U_{f/k+}$	250	V
$U_{f/k-}$	200	V
$R_{f/k}$	20	k Ω
t_{Kolben}	240	°C

Kapazitäten · Capacitances

C_e	19 ± 1,5	pF
C_a	9 ± 1	pF
$C_{g1/a}$	< 1,1	pF

1) Als Endröhre für die horizontale Ablenkung bei Impulsdauer max. 22% einer Periode, $t_{\text{max}} = 18 \mu\text{s}$.

As power tube for horizontal deflection at pulse duration max. 22% per period, $t_{\text{max}} = 18 \mu\text{s}$.

2) Während der Anheizzeit der Boosterdiode $N_{g2 \text{ max}} = 7 \text{ W}$.

During booster diode heating-up period $N_{g2 \text{ max}} = 7 \text{ W}$.

3) Als Endröhre für die horizontale Ablenkung unter Verwendung von Stabilisierungsschaltungen mit Regelung über das Steuergitter ist $R_{g1} = \text{max. } 2,2 \text{ M}\Omega$.

R_{g1} should be limited to 2.2 M Ω when DC-control-voltage is applied to grid No.1 for stabilizing purposes.

4) max. 10 ms.

Sockelschaltbild
Base connection

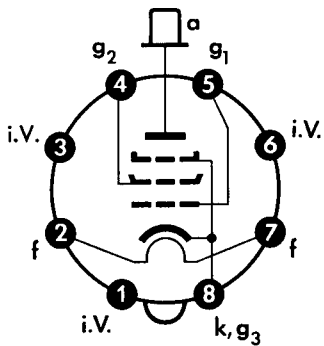

Oktal

Freie Stifte bzw. freie Fassungskontakte dürfen nicht als Stützpunkte für Schaltmittel benutzt werden.

Free pins not to be connected externally.

max. Abmessungen
max. dimensions

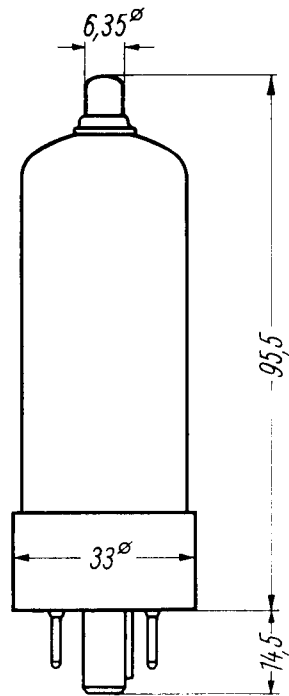

Gewicht · Weight
max. 40 g

Die Anodenanschlußkappe ist mit Nennmaß angegeben.

Nominal measurement of anode clip is given.

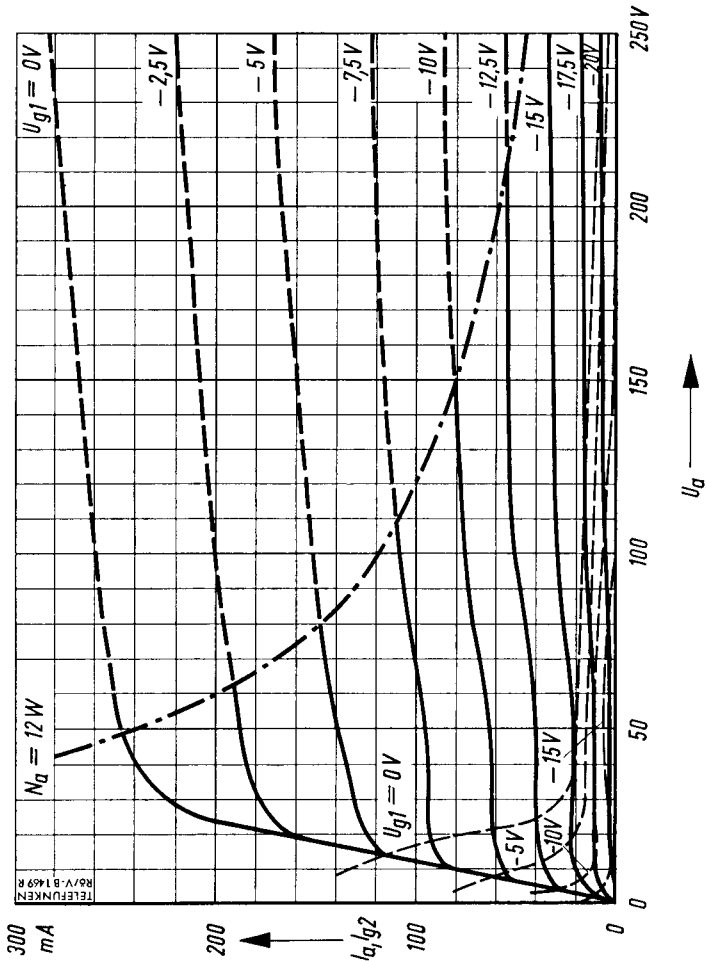

$I_a, I_{g2} = f(U_d)$
 $U_{g2} = 100 V$
 $U_{g1} = \text{Parameter}$

— I_a - - - - I_{g2}

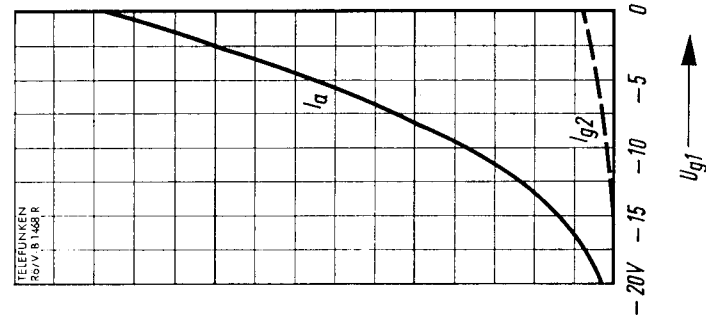

$I_a, I_{g2} = f(U_{g1})$
 $U_a = U_{g2} = 100 V$



TELEFUNKEN

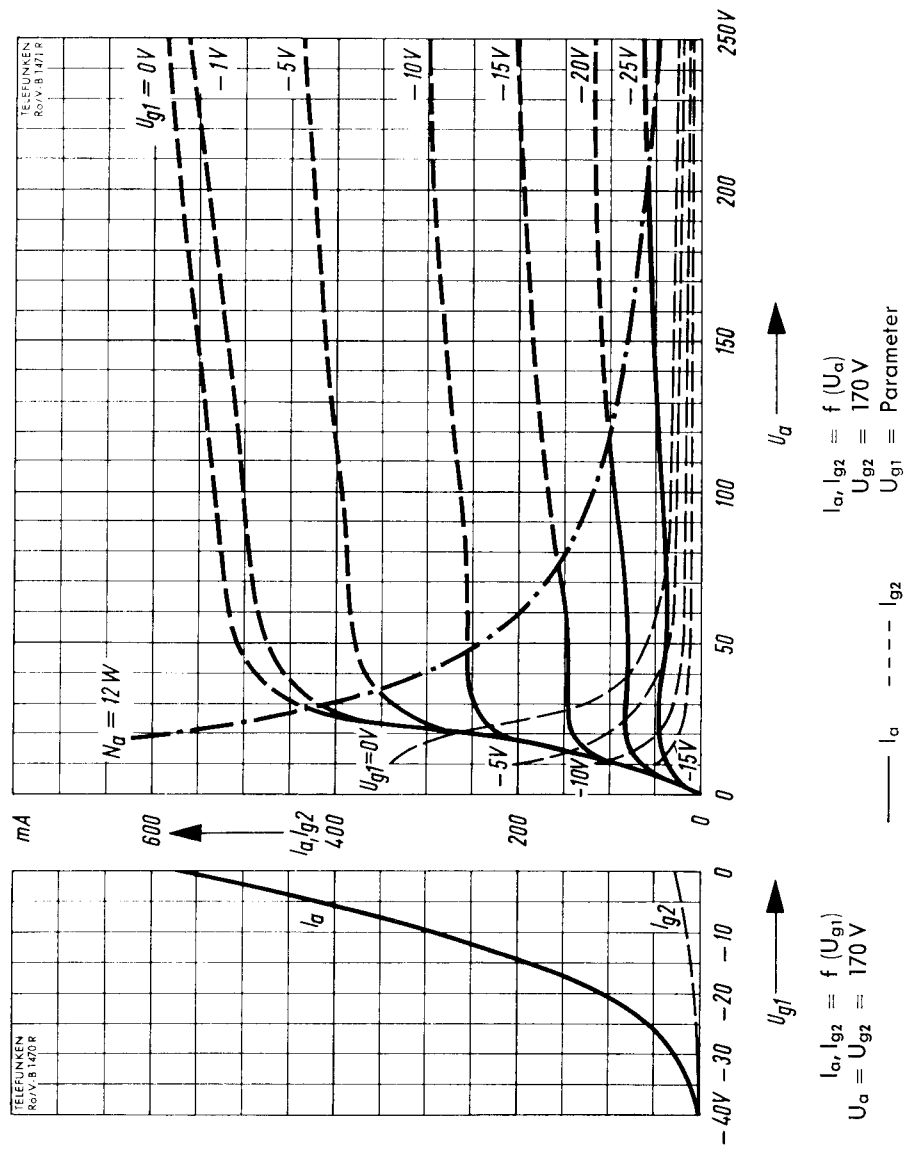

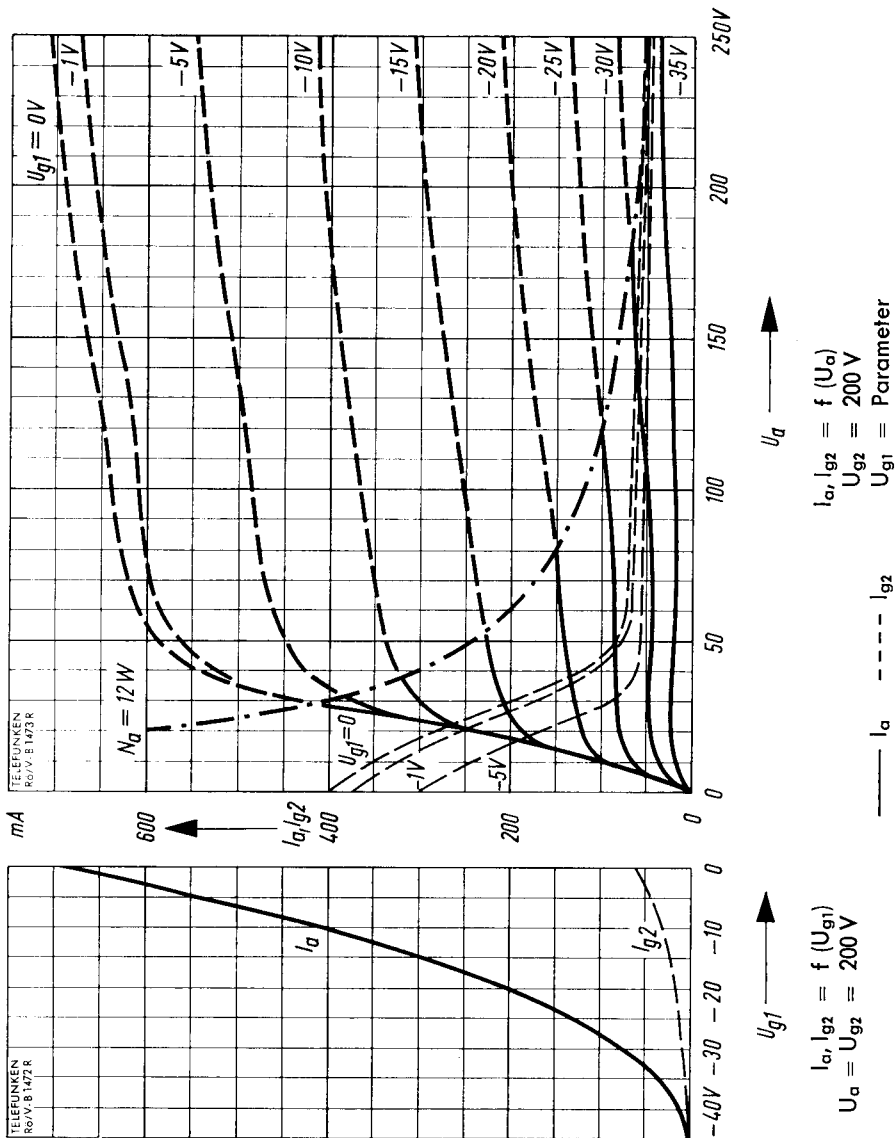

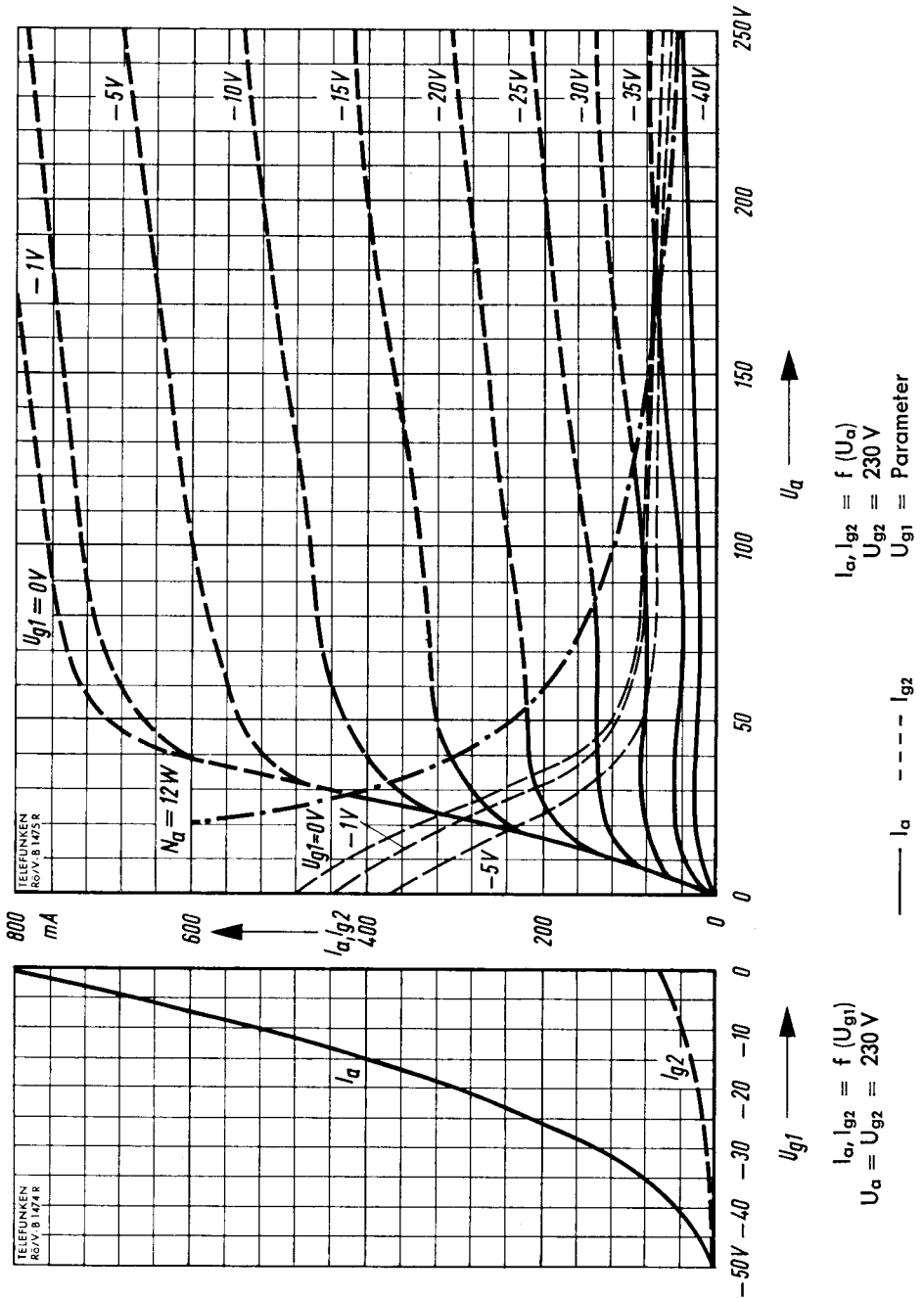

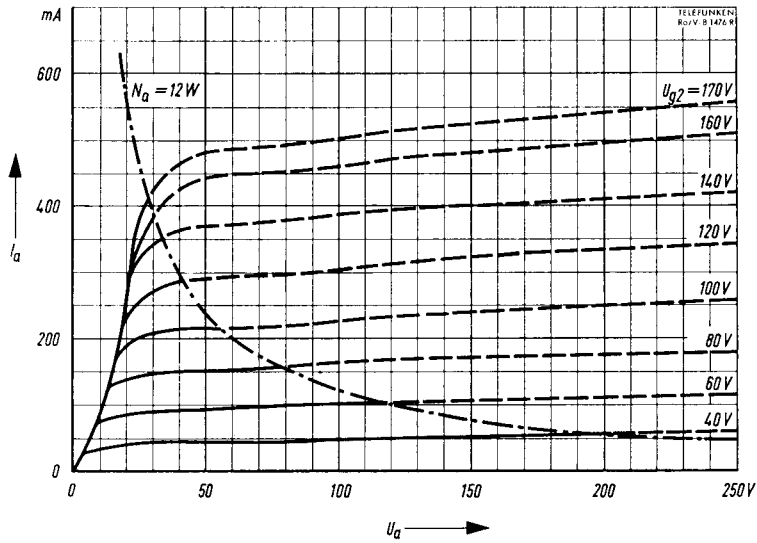

$I_a = f(U_a)$
 $U_{g2} = \text{Parameter}$
 $U_{g1} = -1 V$

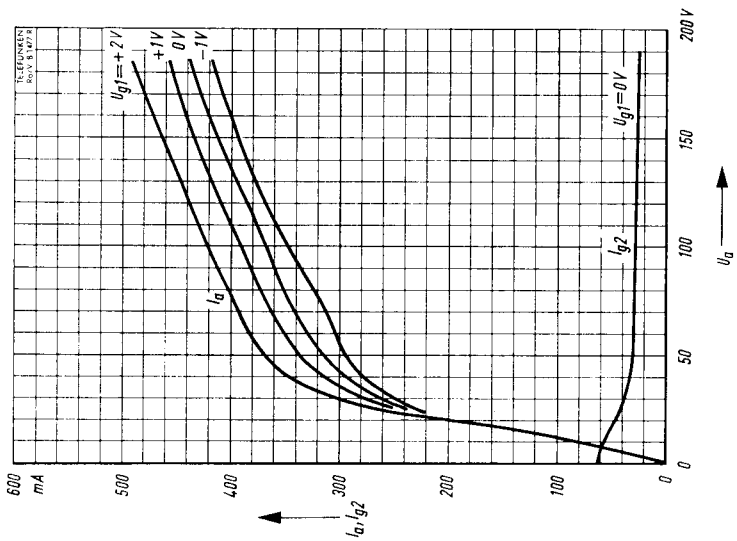

$I_a, I_{g2} = f(U_a)$
 $U_{bg2} = 190 V$
 $R_{g2} = 2,2 k\Omega$
 $U_{g1} = \text{Parameter}$

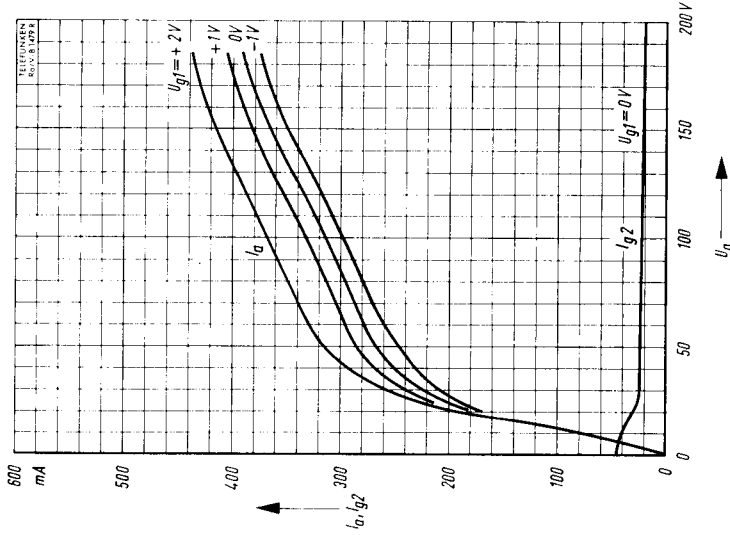

$I_{c1}, I_{g2} = f(U_{g1})$
 $U_{bg2} = 190 V$
 $R_{g2} = 3,3 k\Omega$
 $U_{g1} = \text{Parameter}$

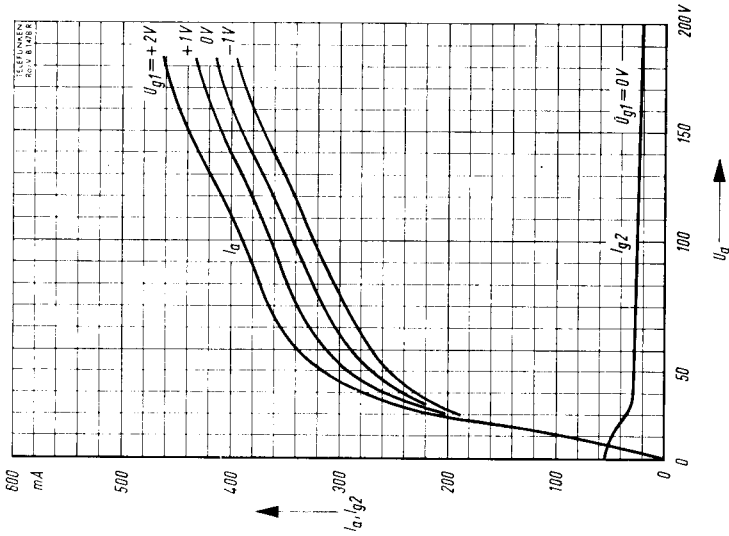

$I_{c1}, I_{g2} = f(U_{g1})$
 $U_{bg2} = 190 V$
 $R_{g2} = 2,7 k\Omega$
 $U_{g1} = \text{Parameter}$



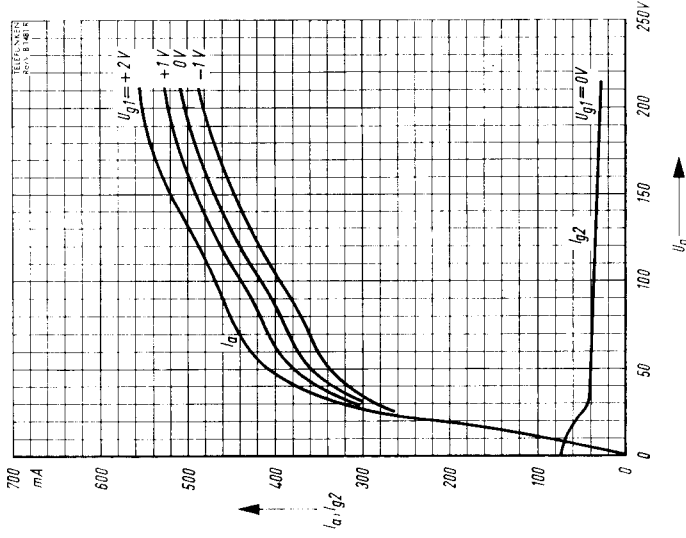

$I_c, I_{g2} = f(U_a)$
 $U_{bg2} = 215 V$
 $R_{g2} = 2,2 k\Omega$
 $U_{g1} = \text{Parameter}$

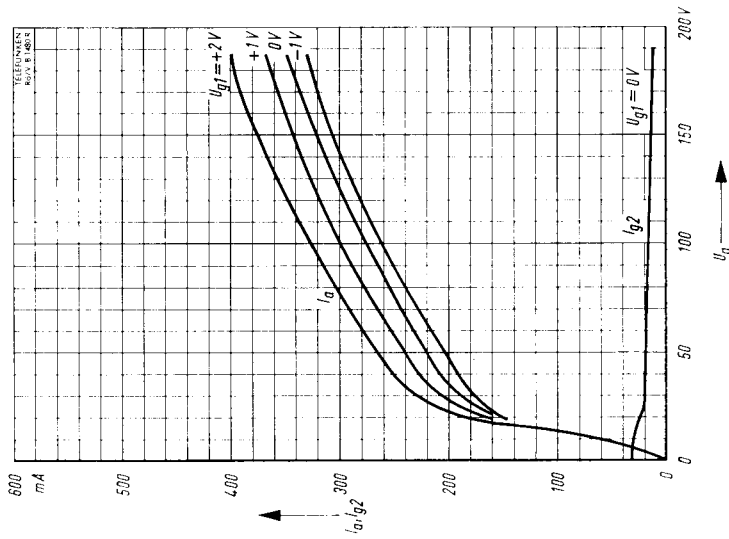

$I_c, I_{g2} = f(U_a)$
 $U_{bg2} = 190 V$
 $R_{g2} = 4,7 k\Omega$
 $U_{g1} = \text{Parameter}$



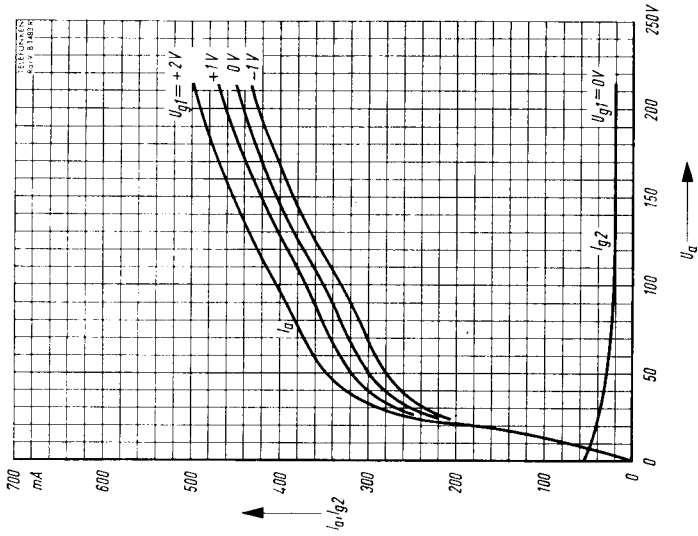

$I_{D1}, I_{G2} = f(U_G)$
 $U_{B_{G2}} = 215V$
 $R_{G2} = 3,3 k\Omega$
 $U_{G1} = \text{Parameter}$

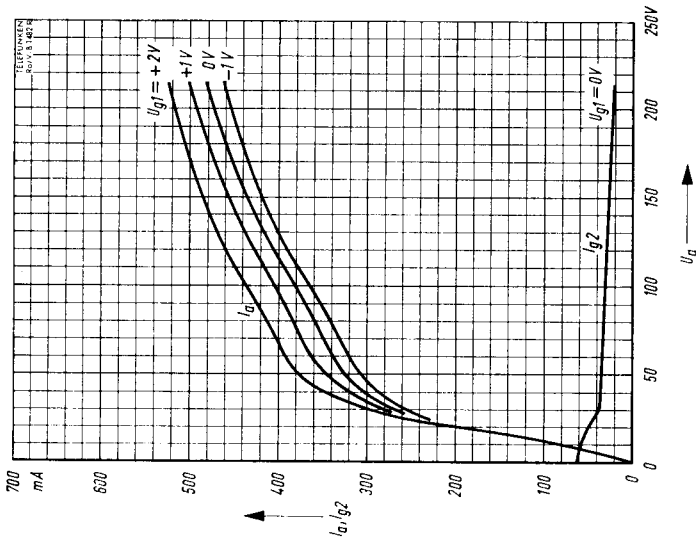

$I_{D1}, I_{G2} = f(U_G)$
 $U_{B_{G2}} = 215V$
 $R_{G2} = 2,7 k\Omega$
 $U_{G1} = \text{Parameter}$



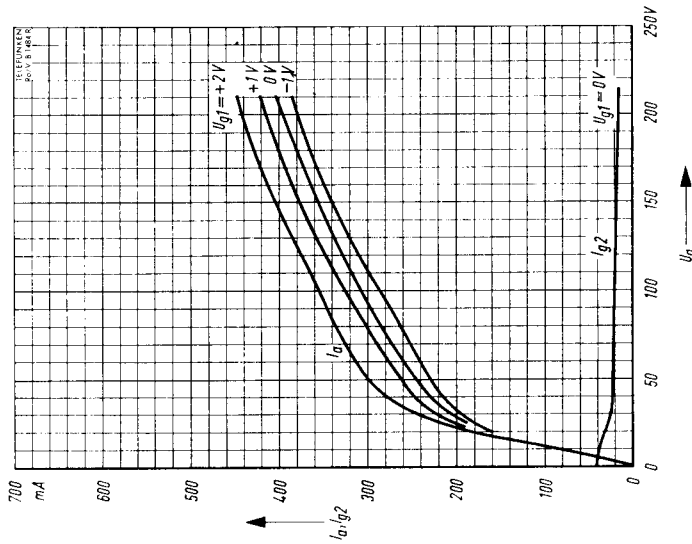
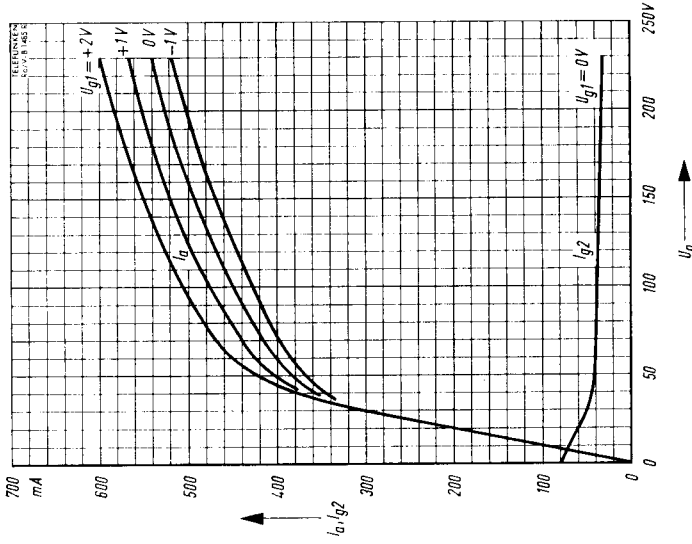

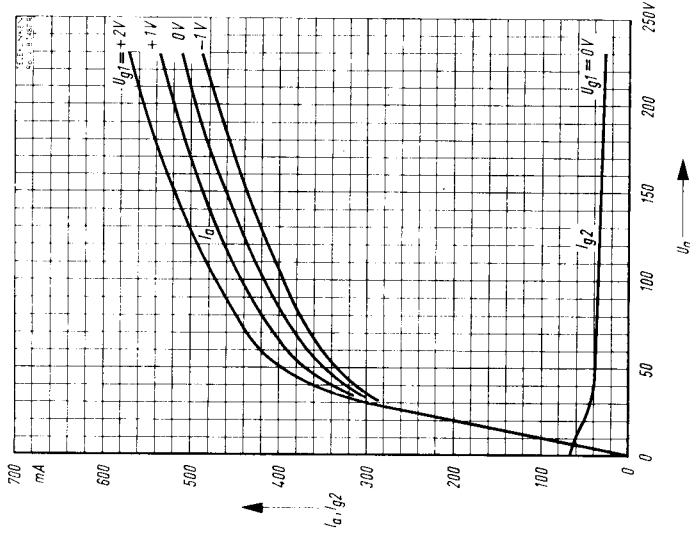

$I_a, I_{g2} = f(U_{g1})$
 $U_{bg2} = 230 \text{ V}$
 $R_{g2} = 2,7 \text{ k}\Omega$
 $U_{g1} = \text{Parameter}$

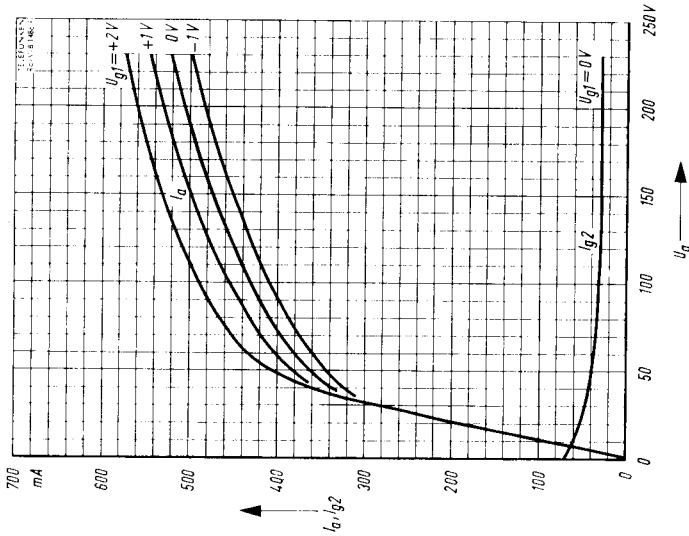

$I_a, I_{g2} = f(U_{g1})$
 $U_{bg2} = 230 \text{ V}$
 $R_{g2} = 2,5 \text{ k}\Omega$
 $U_{g1} = \text{Parameter}$



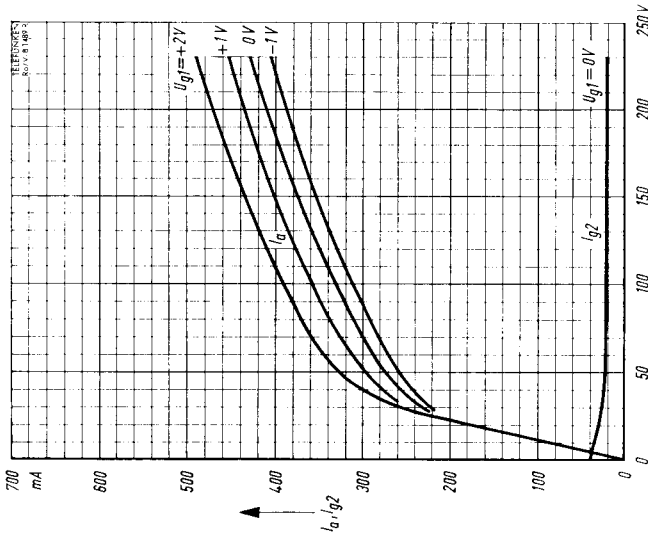

$I_a, I_{g2} = f(U_a)$
 $U_{bg2} = 230V$
 $R_{g2} = 4,7 k\Omega$
 $U_{g1} = \text{Parameter}$

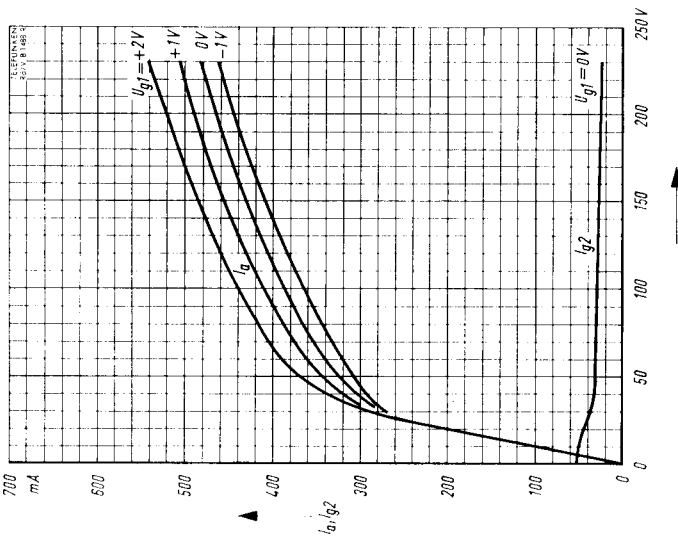

$I_a, I_{g2} = f(U_a)$
 $U_{bg2} = 230V$
 $R_{g2} = 3,3 k\Omega$
 $U_{g1} = \text{Parameter}$



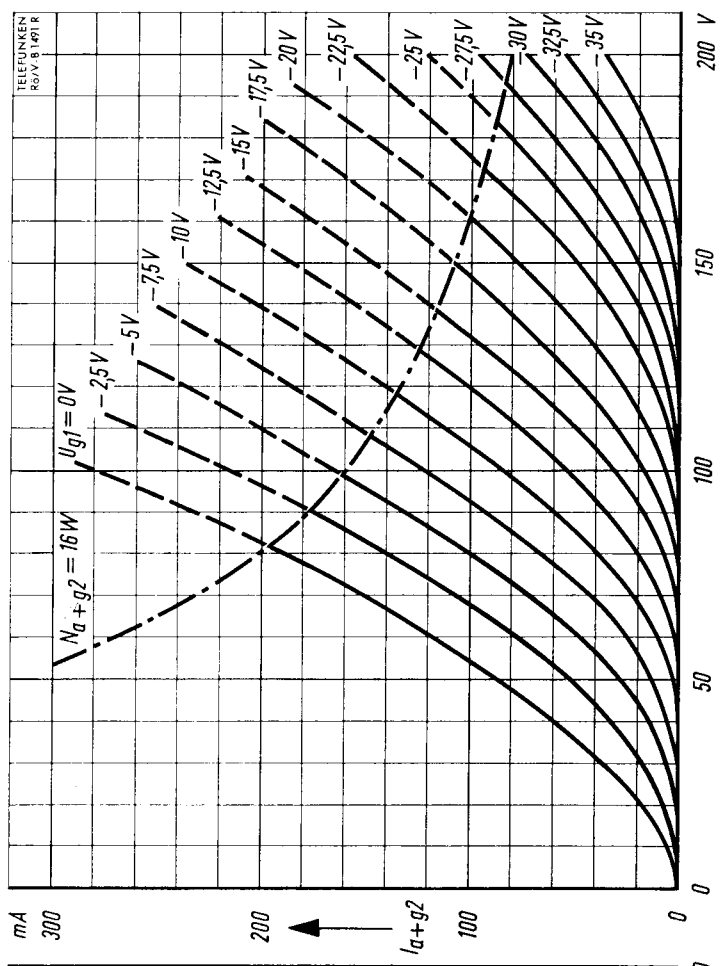

$I_{a+g2} = f(U_{ag2})$
 $U_{g1} = \text{Parameter}$

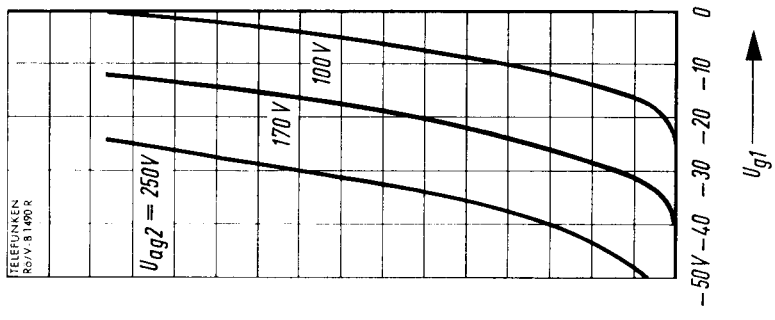

$I_{a+g2} = f(U_{g1})$
 $U_{ag2} = \text{Parameter}$

Als Triode geschaltet · Connected as triode



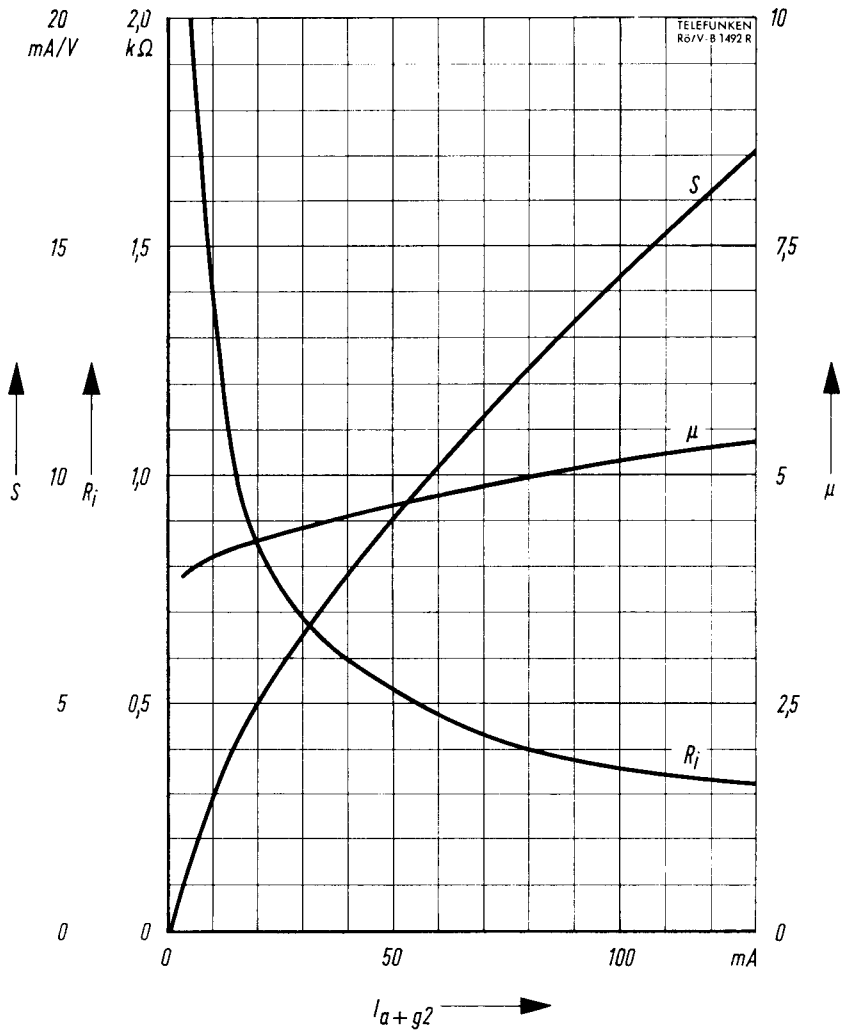

$S, R_i, \mu = f(I_a + g_2)$
 $U_{ag2} = 100 \text{ V}$

Als Triode geschaltet · Connected as triode



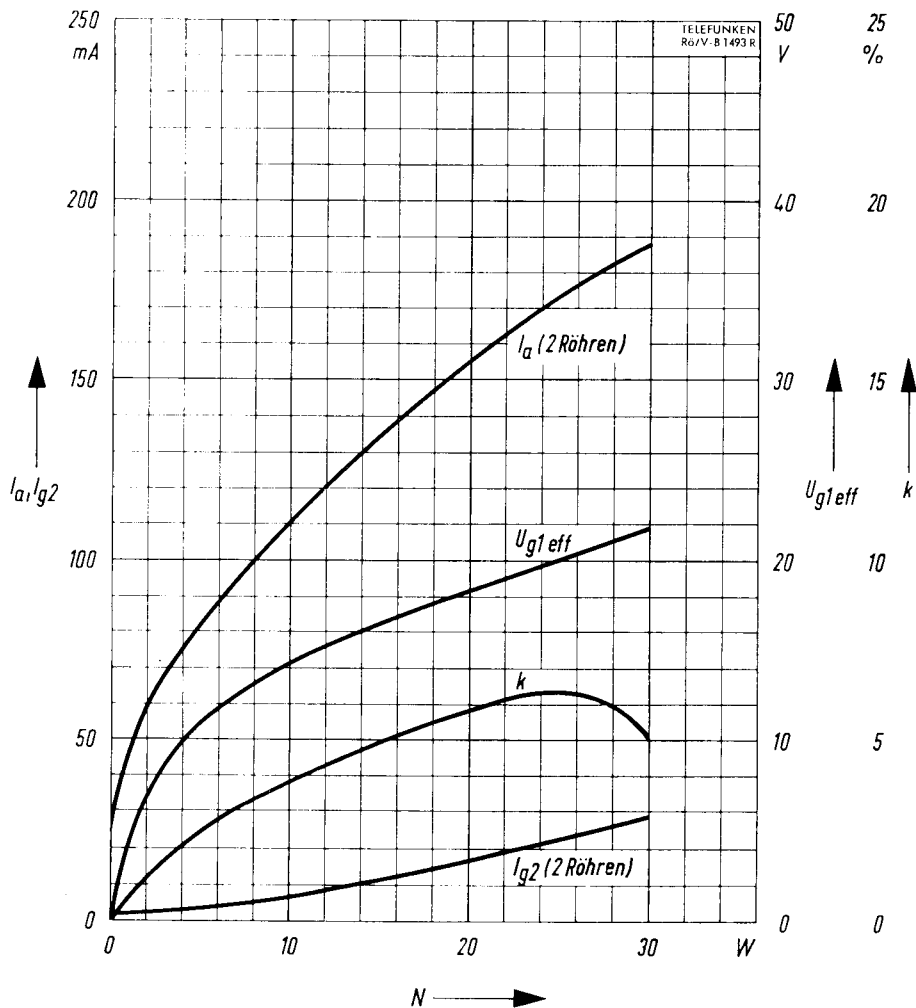

$I_a, I_{g2}, U_{g1eff}, k = f(N)$
 $U_a = 250 \text{ V}$
 $U_{g2} = 170 \text{ V}$
 $U_{g1} = -34 \text{ V}$
 $R_{aa} = 3 \text{ k}\Omega$
 $R_{g2} = 2 \times 0,5 \text{ k}\Omega$

2 Röhren in **Gegentakt-B-Betrieb** · 2 tubes push-pull, class B

