

High Precision Positioning Inductive Proximity Sensor

E2C-EDA

CSM_E2C-EDA_DS_E_5_1

Proximity Sensor with Separate Amplifier Enables Easily Making High-precision Sensitivity Settings.

- Wide variety of Sensor Heads to select according to the application. The Sensor Heads use flexible cable.
- High resistance to changes in ambient temperature. Temperature characteristics of 0.08%/°C (for 5.4-dia. models).
- Make simple and reliable detection settings with micron-level precision using the teaching function.
- Check the sensing excess gain level on the digital display.
- Support for high-precision positioning and screening with fine positioning to maximize variations.



CE







Be sure to read *Safety Precautions* on page 9.

Ordering Information

Sensors [Refer to *Dimensions* on page 11.]

Sensor Heads

Type	Appearance	Sensing distance	Repeat accuracy	Model	
	 Cylindrical	3 dia. × 18 mm	0.6 mm	1 μm	E2C-EDR6-F *2
		5.4 dia. × 18 mm	1 mm	1 μm	E2C-ED01-□ *1 *2 *3
		8 dia. × 22 mm	2 mm	2 μm	E2C-ED02-□ *1 *2 *3
Shielded	 Screw	M10 × 22 mm	2 mm	2 μm	E2C-EM02-□ *1 *2 *3
		 Flat	30 × 14 × 4.8 mm	5 mm	2 μm
Unshielded	 Screw		M18 × 46.3 mm	7 mm	5 μm
Heat-resistant	 Screw	M12 × 22 mm	2 mm	2 μm	E2C-EM02H *2

*1 A Protective Spiral Tube is provided with models ending in the suffix -S. (example: E2C-ED01-S).

For detailed dimensions of the Protective Spiral Tube, refer to the information on the E39-F32A on the OMRON website.

*2 Two cable lengths are available. (3-dia.: free-cut type, Heat-resistant type: standard-length only).

Overall length of the standard-length type: 2.5 m, Length from the Sensor Head to the Preamplifier: 2.0 m (Example: E2C-ED01)

Overall length of the free-cut type: 3.5 m, Length from the Sensor Head to the Preamplifier: 0.5 m for models ending in the suffix -F (example: E2C-ED01F).

*3 Models ending in the suffix -S that come with Protective Spiral Tubes and free-cut models ending in the suffix -F are made-to-order products.

Amplifier Units

Amplifier Units with Cables

Item		Appearance	Functions	Model	
				NPN output	PNP output
Advanced models	Twin-output models		Area output, open circuit detection, differential operation	E2C-EDA11 2M	E2C-EDA41 2M
	External-input models			E2C-EDA21 2M	E2C-EDA51 2M

Amplifier Units with Connectors (An Amplifier Unit Connector (sold separately) is required.)

Item		Appearance	Functions	Model	
				NPN output	PNP output
Advanced models	Twin-output models		Area output, open circuit detection, differential operation	E2C-EDA6	E2C-EDA8
	External-input models			E2C-EDA7	E2C-EDA9

Amplifier Unit Connectors (Order Separately)

Note: Protector seals provided. [Refer to E3X-DA-S/MDA.]

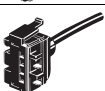
Item	Appearance	Cable length	No. of conductors	Model
Master Connector		2 m	4	E3X-CN21
Slave Connector			2	E3X-CN22

Ordering Precautions for Amplifier Units with Connectors

A Connector is not provided with the Amplifier Unit.





Refer to the following tables when ordering.

Amplifier Unit			Applicable Connector (Order Separately)	
Model	NPN output	PNP output	Master Connector	Slave Connector
Advanced models	E2C-EDA6	E2C-EDA8	+	E3X-CN21
	E2C-EDA7	E2C-EDA9		

When Using 5 Amplifier Units

Amplifier Units (5 Units)	+	1 Master Connector	4 Slave Connectors
---------------------------	---	--------------------	--------------------

Mobile Console (Order Separately) [Refer to E3X-DA-S/MDA.]

Appearance	Model	Remarks
	E3X-MC11-SV2 (model number of set)	Mobile Console with Head, Cable, and AC adapter provided as accessories
	E3X-MC11-C1-SV2	Mobile Console
	E3X-MC11-H1	Head
	E39-Z12-1	Cable (1.5 m)

Note: Use the E3X-MC11-SV2 Mobile Console with E2C-EDA-series Amplifier Units. If you use a Mobile Console like the E3X-MC11-S, some functions may not operate. For details, refer to *Ratings and Specifications* for E3X-DA-S/MDA.

Accessories (Order Separately)

Mounting Bracket

A Mounting Bracket is not provided with the Amplifier Unit. Order a Mounting Bracket separately if required.

[Refer to E39-L, F39-L, E39-S, and E39-R.]

Appearance	Model	Quantity
	E39-L143	1

End Plate

An End Plate is not provided with the Amplifier Unit. Order an End Plate separately if required.

[Refer to PFP-□.]

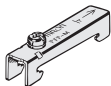
Appearance	Model	Quantity
	PFP-M	1

Extension Cables between Sensor Head and Amplifier Unit

A Mounting Bracket is not provided with the Amplifier Unit. Order an Extension Cable separately if required.

[Refer to Dimensions on page 12.]

Cable length	Model	Quantity
2 m	E22-XC2R	1
7 m	E22-XC7R	

Rating and Specifications

Sensor Heads

Item	Model	E2C-EDR6-F	E2C-ED01(-□)	E2C-ED02(-□)	E2C-EM02(-□)	E2C-EM07(-□)	E2C-EV05(-□)	E2C-EM02H	
		3 dia. × 18 mm	5.4 dia. × 18 mm	8 dia. × 22 mm	M10 × 22 mm	M18 × 46.3 mm	30 × 14 × 4.8 mm	M12 × 22 mm	
Sensing distance		0.6 mm	1 mm	2 mm		7 mm	5 mm	2 mm	
Sensing object		Magnetic metal (The sensing distance will decrease when sensing non-magnetic metal. Refer to <i>Engineering Data</i> on page 5.)							
Standard sensing object		5 × 5 × 3 mm		10 × 10 × 3 mm		22 × 22 × 3 mm	15 × 15 × 3 mm	20 × 20 × 3 mm	
		Material: iron (S50C)							
Repeat accuracy *1		1 μm		2 μm		5 μm	2 μm		
Hysteresis distance		Variable							
Temperature characteristic *1	Sensor Head	0.3%/°C	0.08%/°C				0.04%/°C	0.2%/°C	
	Preamplifier and Amplifier	0.08%/°C							
Ambient temperature *2	Operating	-10°C to 60°C (with no icing or condensation)						-10°C to 200°C *3	
	Storage	-10°C to 60°C (with no icing or condensation)	-20°C to 70°C (with no icing or condensation)						
Ambient humidity		Operating/storage: 35% to 85% (with no condensation)							
Insulation resistance		50 MΩ min. (at 500 VDC)							
Dielectric strength		1,000 VAC at 50/60 Hz for 1 min between current carry parts and case							
Vibration resistance		Destruction: 10 to 55 Hz, 1.5-mm double amplitude for 2 hours each in X, Y, and Z directions							
Shock resistance		Destruction: 500 m/s ² for 3 times each in X, Y, and Z directions							
Degree of protection		IEC60529 IP67						IEC60529 IP60 *4	
Connection method		Connector (standard cable length: 2.5 m (2 m between Head and Preamplifier) “-F” model cable length: 3.5 m (0.5 m between Head and Preamplifier)							
Weight (packed state)		Approx. 120 g (Models with protective spiral tube (“-S” models) are approx. 90 g heavier.)							
Material	Sensor Head	Case	Brass	Stainless steel	Brass			Zinc	Brass
		Sensing surface	Heat-resistant ABS						PEEK
		Clamping nut	---			Nickel-plated brass		---	Nickel-plated brass
		Toothed washer	---			Zinc-plated iron		---	Zinc-plated iron
	Preamplifier	PES							
Accessories		Preamplifier Mounting Brackets, Instruction Manual							

*1 The repeat accuracy and temperature characteristic are for a standard sensing object positioned midway through the rated sensing distance.

*2 A sudden temperature rise even within the rated temperature range may degrade characteristics.

*3 For the Sensor Head only without the preamplifier (-10 to 60°C). With no icing or condensation.

*4 Do not operate in areas exposed to water vapor because the enclosure is not waterproof.

Amplifier Units

Item	Type		Advanced Models with Twin Outputs		Advanced Models with External Inputs	
	Model	NPN output	E2C-EDA11	E2C-EDA6	E2C-EDA21	E2C-EDA7
		PNP output	E2C-EDA41	E2C-EDA8	E2C-EDA51	E2C-EDA9
Supply voltage			12 to 24 VDC \pm 10%, ripple (p-p): 10% max.			
Power consumption			1,080 mW max. (current consumption: 45 mA at power supply voltage of 24 VDC)			
Control output			Load power supply voltage: 26.4 VDC max.; NPN/PNP open collector output; load current: 50 mA max. (residual voltage: 1 V max.)			
Response time	Super-high-speed mode *		150 μ s for operation and reset respectively			
	High-speed mode		300 μ s for operation and reset respectively			
	Standard mode		1 ms for operation and reset respectively			
	High-resolution mode		4 ms for operation and reset respectively			
Functions	Differential detection		Switchable between single edge and double edge detection mode Single edge: Can be set to 300 μ s, 500 μ s, 1 ms, 10 ms, or 100 ms Double edge: Can be set to 500 μ s, 1 ms, 2 ms, 20 ms, or 200 ms.			
	Timer function		Select from OFF-delay, ON-delay, or one-shot timer. 1 ms to 5 s (1 to 20 ms set in 1-ms increments, 20 to 200 ms set in 10-ms increments, 200 ms to 1 s set in 100-ms increments, and 1 to 5 s set in 1 s-increments)			
	Zero-reset		Negative values can be displayed. (Threshold is not shifted.)			
	Initial reset		Settings can be returned to defaults as required.			
	Mutual interference prevention		Possible for up to 5 Units. * Intermittent oscillation method (Response time = (number of Units connected + 1) \times 15 ms)			
	Hysteresis settings		Setting range: 10 to 4,000			
	I/O settings		Output setting (Select from channel 2 output, area output, self-diagnosis, or open circuit detection.)		Input setting (Select from teaching, fine positioning, zero-reset, synchronous detection.)	
Digital display			Select from the following: Incident level + threshold, incident level percentage + threshold, incident light peak level + incident light bottom level (updated with output), long bar display, incident level + peak hold, incident level + channel			
Display orientation			Switching between normal/reversed display is possible.			
Ambient temperature			Operating: When connecting 1 to 2 Units: -10°C to 55°C When connecting 3 to 5 Units: -10°C to 50°C When connecting 6 to 16 Units: -10°C to 45°C When used in combination with an EDR6-F When connecting 3 to 4 Units: -10°C to 50°C When connecting 5 to 8 Units: -10°C to 45°C When connecting 9 to 16 Units: -10°C to 40°C Storage: -20°C to 70°C (with no icing)			
Ambient humidity			Operating/storage: 35% to 85% (with no condensation)			
Insulation resistance			20 M Ω min. (at 500 VDC)			
Dielectric strength			1,000 VAC at 50/60 Hz for 1 min			
Vibration resistance			Destruction: 10 to 55 Hz, 1.5-mm double amplitude for 2 hours each in X, Y, and Z directions			
Shock resistance			Destruction: 500 m/s ² for 3 times each in X, Y, and Z directions			
Degree of protection			IEC60529 IP50			
Connection method			Prewired	Connector	Prewired	Connector
Weight (packed state)			Approx. 100 g	Approx. 55 g	Approx. 100 g	Approx. 55 g
Material	Case		PBT (polybutylene terephthalate)			
	Cover		Polycarbonate			

* Communications are disabled if the detection mode is selected during super-high-speed sensing mode, and the communications functions for mutual interference prevention and the Mobile Console will not function.

Engineering Data

Sensing Distance vs. Display Values

E2C-EDR6-F

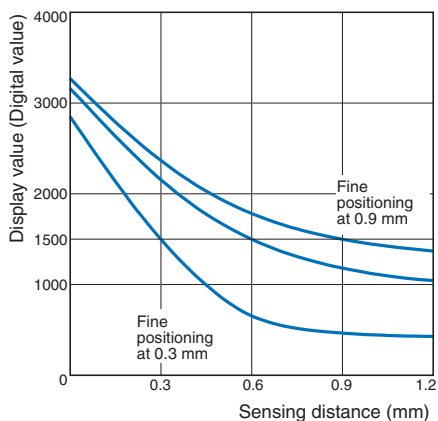

E2C-ED01(-□)

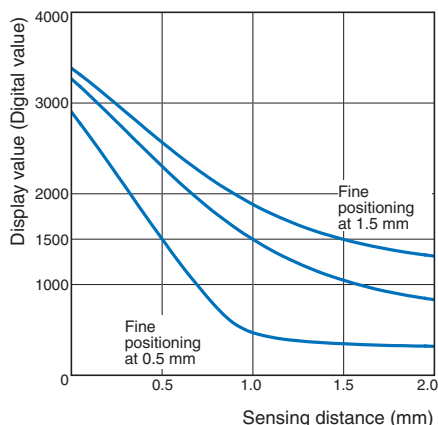

E2C-ED02(-□)/EM02(-□)

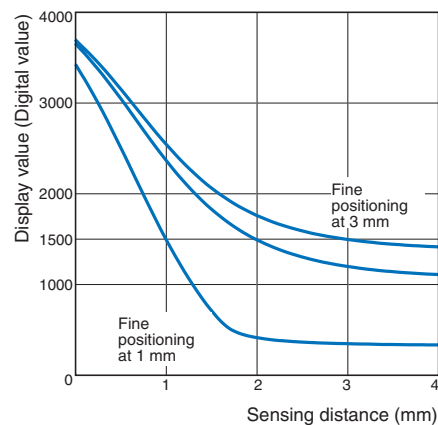

E2C-EM07(-□)

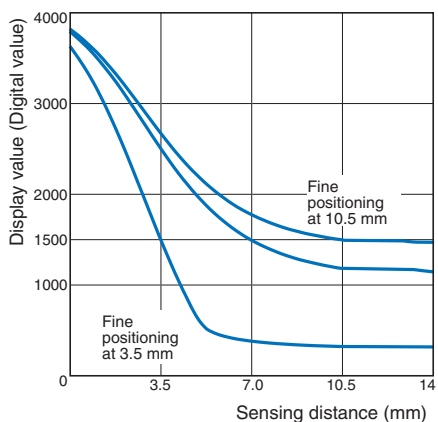

E2C-EV05(-□)

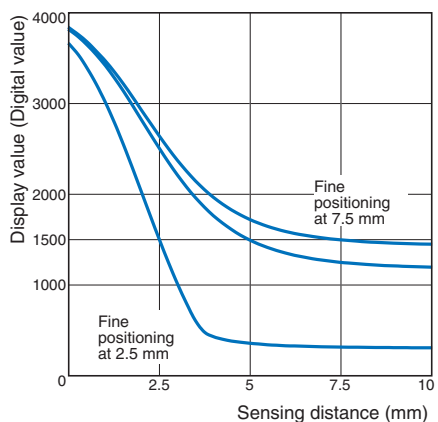

E2C-EM02H

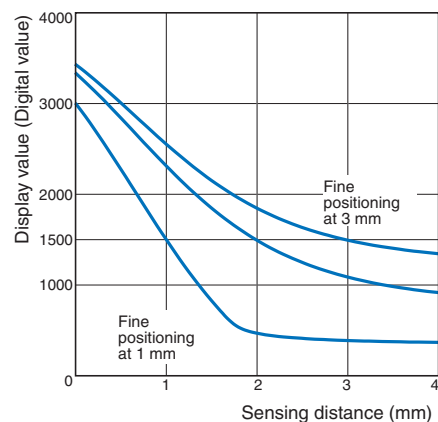

Influence of Sensing Object Size and Material

E2C-EDR6-F

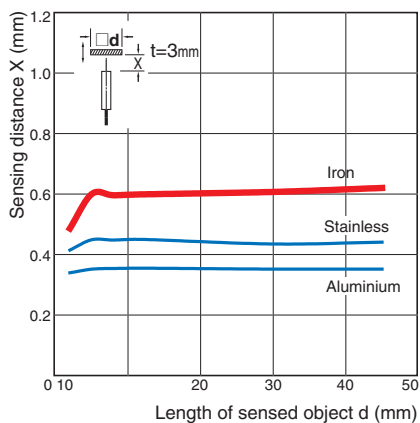

E2C-ED01(-□)

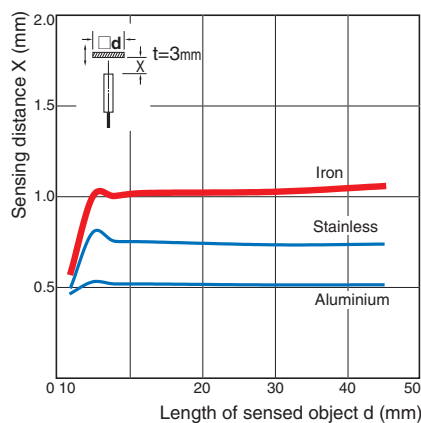

E2C-ED02(-□)/EM02(-□)

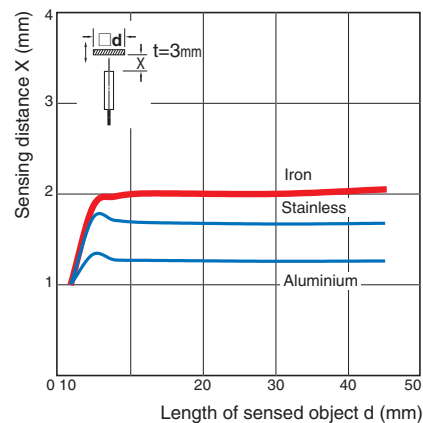

E2C-EM07(-□)

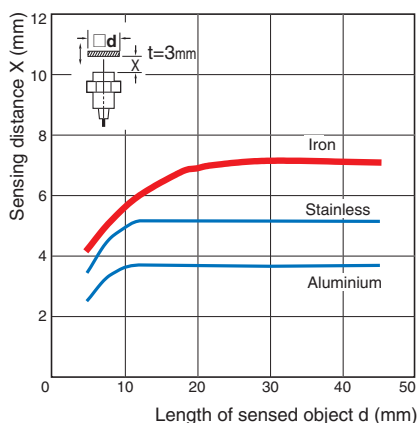

E2C-EV05(-□)

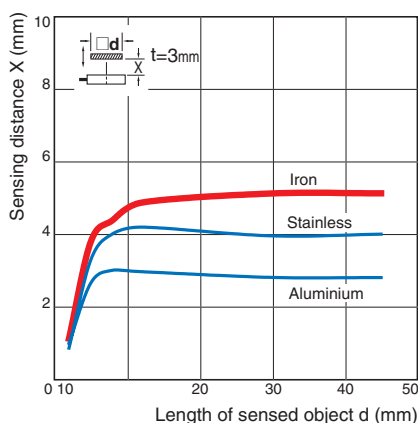

E2C-EM02H

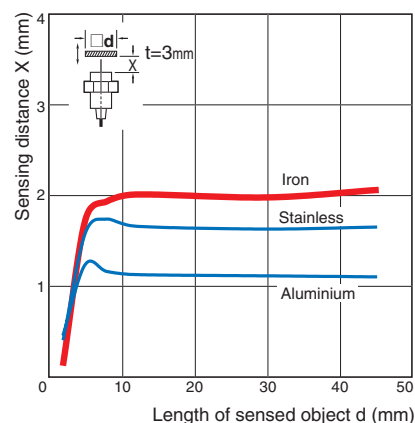

Influence of Sensor Head Temperature

E2C-EDR6-F

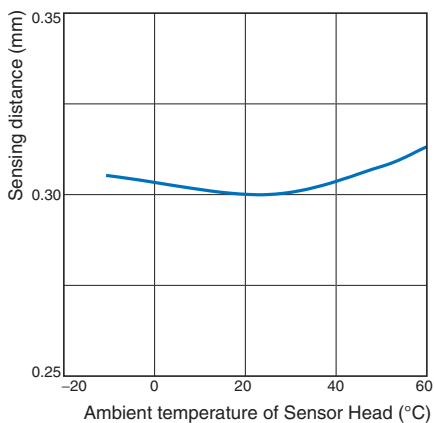

E2C-ED01(-□)

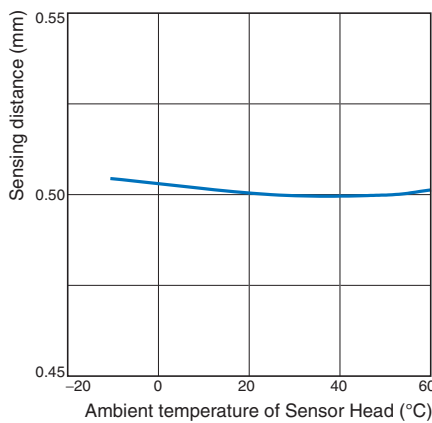

E2C-ED02(-□)/EM02(-□)

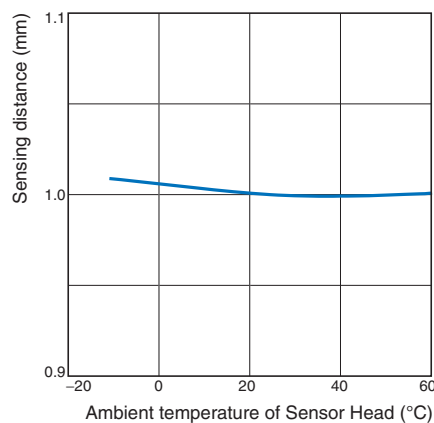

E2C-EM07(-□)

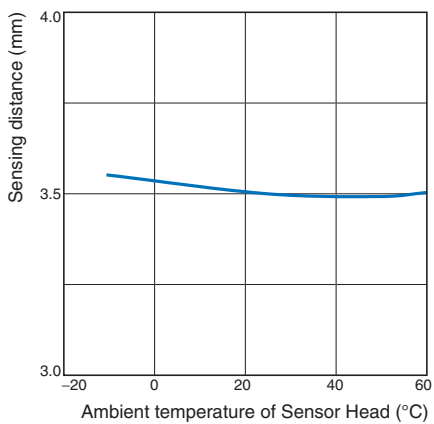

E2C-EV05(-□)

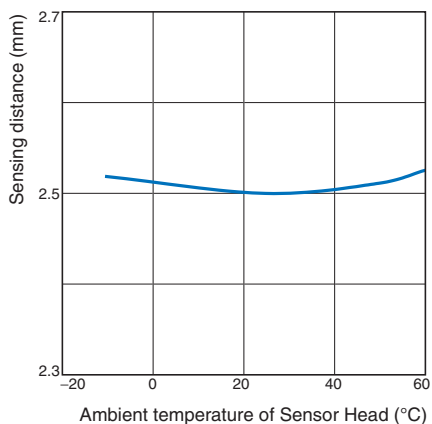

E2C-EM02H

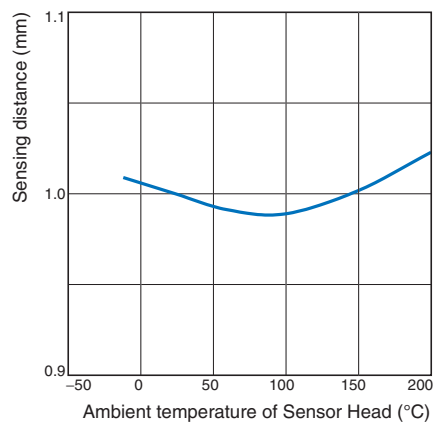

I/O Circuit Diagrams

NPN Output

Model	Operation mode	Timing chart	Mode selector	Output circuit
E2C-EDA11 E2C-EDA6	NO (Normally open)	Sensing object: Yes (ON), No (OFF) Operation indicator (orange): Lit (ON), Not lit (OFF) Output transistor: ON (ON), OFF (OFF) Load (relay, etc.): Operate (ON), Reset (OFF) (Between brown and black lines)	NO	
	NC (Normally closed)	Sensing object: Yes (OFF), No (ON) Operation indicator (orange): Lit (OFF), Not lit (ON) Output transistor: ON (OFF), OFF (ON) Load (relay, etc.): Operate (OFF), Reset (ON) (Between brown and black lines)	NC	
E2C-EDA21 E2C-EDA7	NO (Normally open)	Sensing object: Yes (ON), No (OFF) Operation indicator (orange): Lit (ON), Not lit (OFF) Output transistor: ON (ON), OFF (OFF) Load (relay, etc.): Operate (ON), Reset (OFF) (Between brown and black lines)	NO	
	NC (Normally closed)	Sensing object: Yes (OFF), No (ON) Operation indicator (orange): Lit (OFF), Not lit (ON) Output transistor: ON (OFF), OFF (ON) Load (relay, etc.): Operate (OFF), Reset (ON) (Between brown and black lines)	NC	

- Note: 1.** Setting Areas for Twin-output Models
 Normally open:ON between the thresholds for Channel 1 and Channel 2
 Normally closed: ..OFF between the thresholds for Channel 1 and Channel 2
- 2.** Timing Charts for Timer Settings (T: Set Time)

ON delay	OFF delay	One shot

PNP Output

Model	Operation mode	Timing chart	Mode selector	Output circuit
E2C-EDA41 E2C-EDA8	NO (Normally open)	Sensing object: Yes (ON), No (OFF) Operation indicator (orange): Lit (ON), Not lit (OFF) Output transistor: ON (ON), OFF (OFF) Load (relay, etc.): Operate (ON), Reset (OFF) (Between blue and black lines)	NO	
	NC (Normally closed)	Sensing object: Yes (OFF), No (ON) Operation indicator (orange): Lit (OFF), Not lit (ON) Output transistor: ON (OFF), OFF (ON) Load (relay, etc.): Operate (OFF), Reset (ON) (Between blue and black lines)	NC	
E2C-EDA51 E2C-EDA9	NO (Normally open)	Sensing object: Yes (ON), No (OFF) Operation indicator (orange): Lit (ON), Not lit (OFF) Output transistor: ON (ON), OFF (OFF) Load (relay, etc.): Operate (ON), Reset (OFF) (Between blue and black lines)	NO	
	NC (Normally closed)	Sensing object: Yes (OFF), No (ON) Operation indicator (orange): Lit (OFF), Not lit (ON) Output transistor: ON (OFF), OFF (ON) Load (relay, etc.): Operate (OFF), Reset (ON) (Between blue and black lines)	NC	

Note: 1. Setting Areas for Twin-output Models
 Normally open:ON between the thresholds for Channel 1 and Channel 2
 Normally closed: ..OFF between the thresholds for Channel 1 and Channel 2
2. Timing Charts for Timer Settings (T: Set Time)

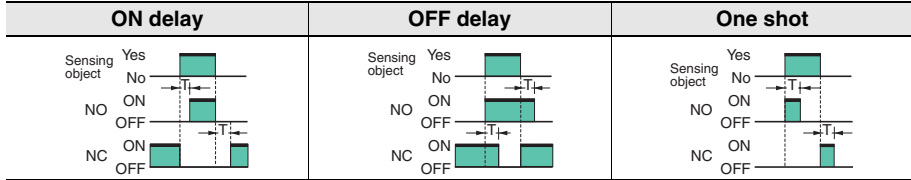

Nomenclature

Amplifier Units

Twin-output Models (E2C-EDA11/EDA41/EDA6/EDA8)

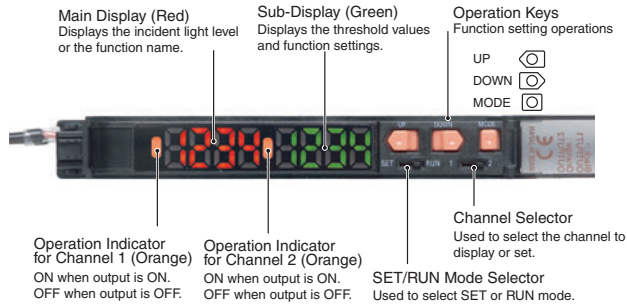

External-input Models (E2C-EDA21/EDA51/EDA7/EDA9)

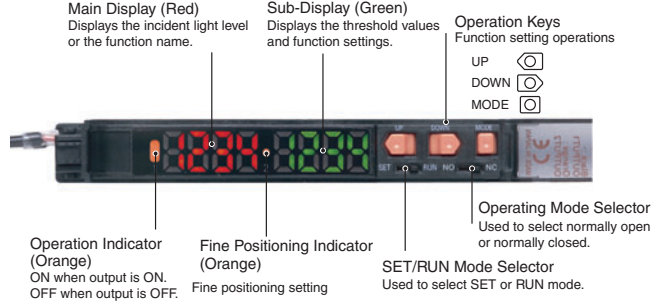

Safety Precautions

Refer to *Warranty and Limitations of Liability*.

⚠ WARNING

Do not use this product in any safety device used for the protection of human lives.



Precautions for Correct Use

Do not use this product in operating atmospheres or environments outside the specified ratings.

Amplifier Units

Design

Power ON

The Sensor is ready to sense an object within 200 ms after turning the power ON. If the load and Sensor are connected to different power supplies, always turn ON the Sensor power first.

Cable

Use an external power cable of cross-section of 0.3 mm² or more for the Amplifier, and the total length of the cable must be 30 m or less.

Connecting Sensor Heads

Connecting and Disconnecting Sensor Heads

1. Open the protective cover.
2. Making sure that the lock button is up, insert the fibers all the way to the back of the Connector insertion opening.

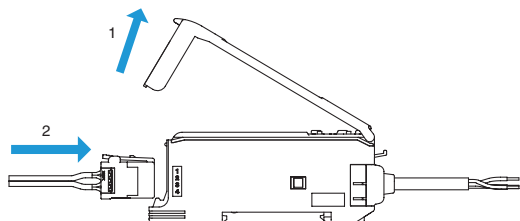

To disconnect the Sensor Head, pull out the fibers while pressing on the lock button.

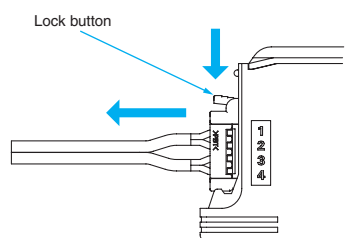

Connecting and Disconnecting Connectors

<Connecting Connectors>

1. Insert the Master or Slave Connector into the Amplifier Unit until it clicks into place.

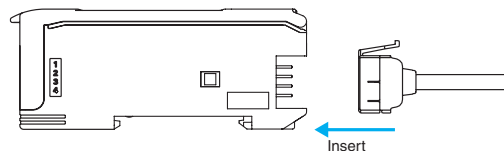

2. Apply the supplied seal to the non-connection surface of the Master/Slave Connector.

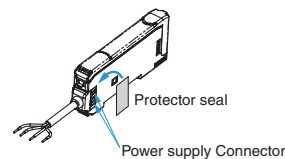

Note: Apply the seal to the grooved side.

<Disconnecting Connectors>

1. Slide the Slave Amplifier Unit.
2. After the Amplifier Unit has been separated, press down on the lever on the Connector and remove it. (Do not attempt to remove Connectors without separating them from other Amplifier Units first.)

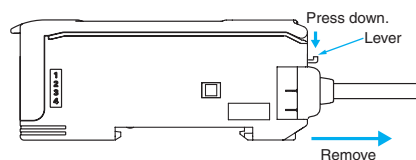

Installing and Removing Amplifier Units

<Installing Amplifier Units>

1. Install the Units one by one to the DIN rail.

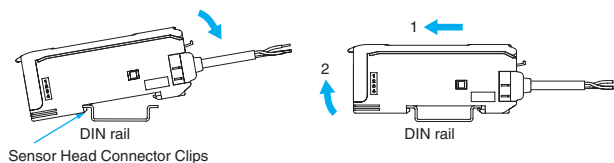

2. Slide one Unit toward the other, match the clips at the front ends, and then bring them together until they "click."

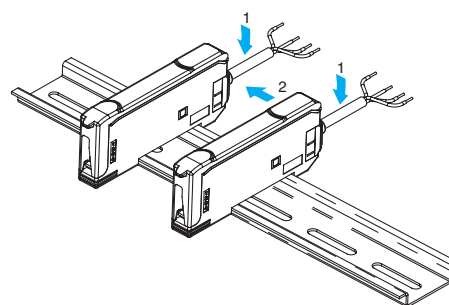

<Removing Amplifier Units>

Slide one Unit away from the other and remove them one by one. (Do not remove the connected Units together from the DIN rail.)

- Note:**
1. When the Amplifier Units are connected to each other, the operable ambient temperature changes depending on the number of connected Amplifier Units. Check Specifications.
 2. Before connecting or disconnecting the Units, always switch power OFF.

End Plate Mounting (PFP-M)

Mount End Plates on Amplifier Units to avoid movement due to vibration. When a Mobile Console is installed, mount the End Plate facing as shown in the following diagram.

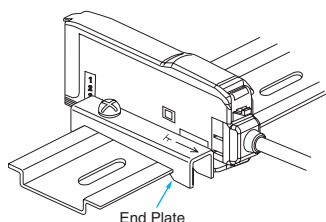

Mounting a Communications Head for the Mobile Console

Leave a space of at least 20 mm on the left side of the Units for a Mobile Console Communications Head.

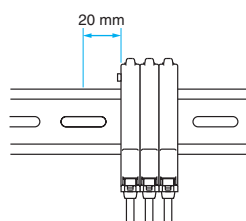

EEPROM Write Error

If the data is not written to the EEPROM correctly due to a power failure or static-electric noise, initialize the settings using the keys on the Amplifier Unit.

Optical Communications

When using more than one Amplifier Unit, mount the Units side-by-side. Do not slide or remove Units while they are in use.

Miscellaneous

Protective Cover

Be sure to put on the Protective Cover before use.

Mobile Console

Use the E3X-MC11-SV2 Mobile Console for E2C-EDA-series Amplifier Units. Other Mobile Consoles, such as the E3X-MC11, cannot be used.

Sensor Head and Amplifier Unit Connection

Be sure to use only specified Sensor Head and Amplifier Unit combinations. The E3C-LDA-series Photoelectric Sensor with Separate Digital Amplifier is not compatible, and the E2C-EDA must not be used with products from that series.

Warm-up

The digital display will slowly change until the circuits stabilize after the power is turned ON. It takes about 30 minutes after the power is turned ON before the E2C-EDA is ready to sense.

Maintenance Inspection

- Be sure to turn OFF the power before adjusting, connecting, or disconnecting the Sensor Head.
- Do not use thinner, benzene, acetone, or kerosene to clean the Sensor Head or Amplifier Unit.

Sensor Heads

Mounting

Mounting Sensor Heads

- Use the dimensions from the following table to mount unthreaded cylindrical models (E2C-ED-□□). Do not tighten screws with torque exceeding 0.2 N·m when mounting Sensor Heads.

Model	Tightening range A
E2C-EDR6-F	9 to 18 mm
E2C-ED01□□	9 to 18 mm
E2C-ED02□□	11 to 12 mm

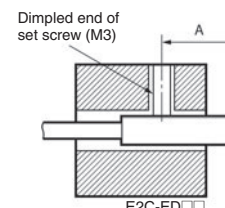

- Use the torque given in the following table to tighten threaded cylindrical models (E2C-EM□□).

Model	Tightening torque
E2C-EM02□□	15 N·m max.
E2C-EM07M□□	15 N·m max.
E2C-EM02H□□	5.9 N·m max.

- Do not use torque exceeding 0.5 N·m to tighten screws when mounting flat models (E2C-EV□□).
- Use a bending radius of at least 8 mm for the Sensor Head cable.
- Use only the special extension cable to extend the cable between the Sensor Head and the Amplifier Unit.

Model	Cable length
E22-XC2R	2 m
E22-XC7R	7 m

Effects of Surrounding Metal

- Provide a minimum distance between the Sensor and the surrounding metal as shown in the table below.

Effects of Surrounding Metal (Units: mm)

Model	Counterbore A	Protrusion B
E2C-EDR6-F	3.1	0
E2C-ED01□□	5.4	0
E2C-ED02□□	8	0
E2C-EM02□□	10	0
E2C-EM07M□□	35	20
E2C-EV05□□	14 × 30	4.8
E2C-EM02H□□	12	0

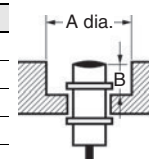

Mutual Interference

- If more than one Sensor Head is installed face to face or in parallel, make sure that the distances between two Units adjacent to each other are the same as or larger than the corresponding values shown in the following table.
- The distance between Sensor Heads may be narrower than specified with these Sensors because the Mutual Interference Prevention Function is used for optical communications between the Amplifier Units.

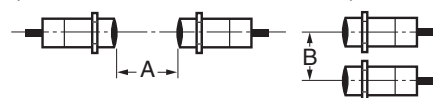

Mutual Interference

(Units: mm)

Model	Face-to-face arrangement A	Parallel arrangement B	Face-to-face arrangement using the Mutual Interference Prevention Function A'	Parallel arrangement using the Mutual Interference Prevention Function B'
E2C-EDR6-F	14	10	3.5	3.1
E2C-ED01□□	45	20	9	5.4
E2C-ED02□□	35	30	21	8
E2C-EM02□□	36	30	21	10
E2C-EM07M□□	140	120	35	18
E2C-EV05□□	65	30	21	14
E2C-EM02H□□	45	30	21	12

Dimensions

Tolerance class IT16 applies to dimensions in this data sheet unless otherwise specified.

Sensors

E2C-EDR6-F

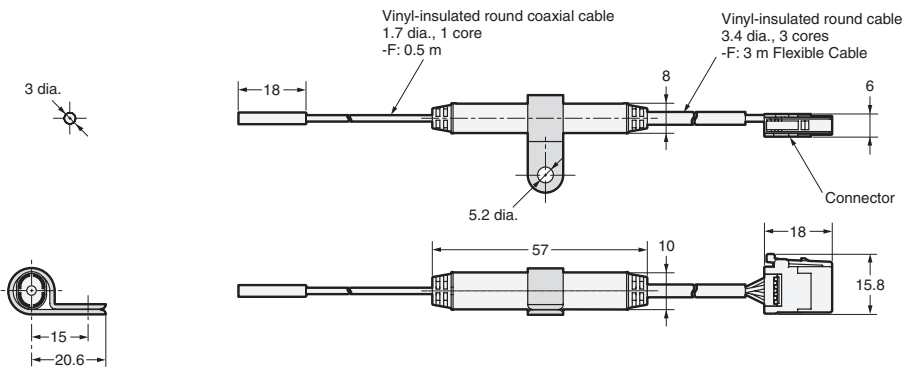

E2C-ED01(-F)

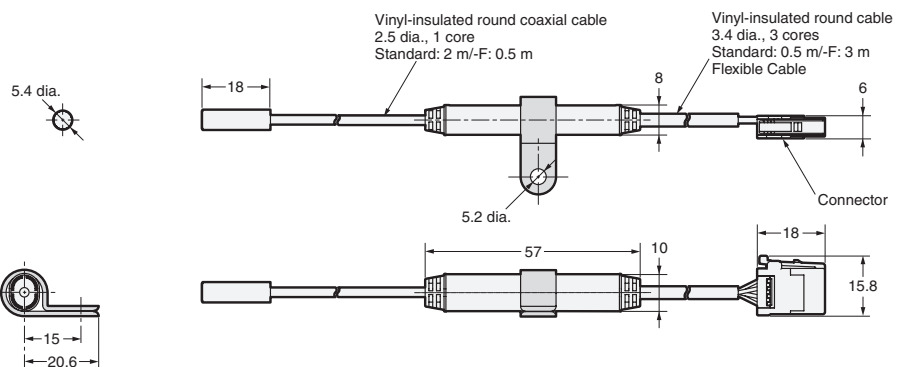

E2C-ED02(-F)

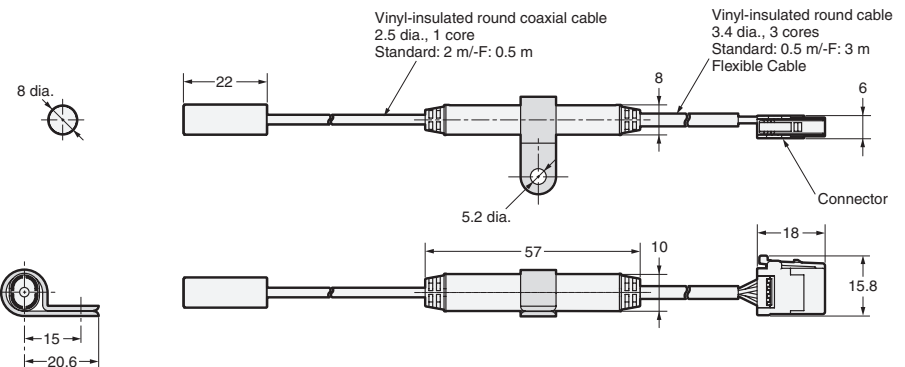

E2C-EM02(-F)

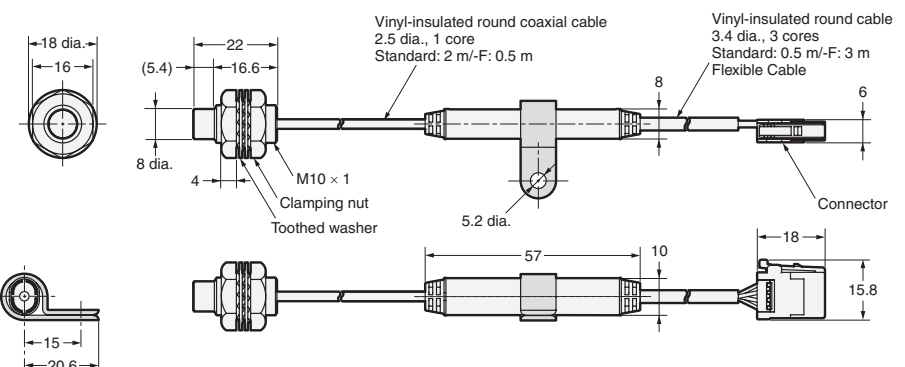

E2C-EM07M(-F)

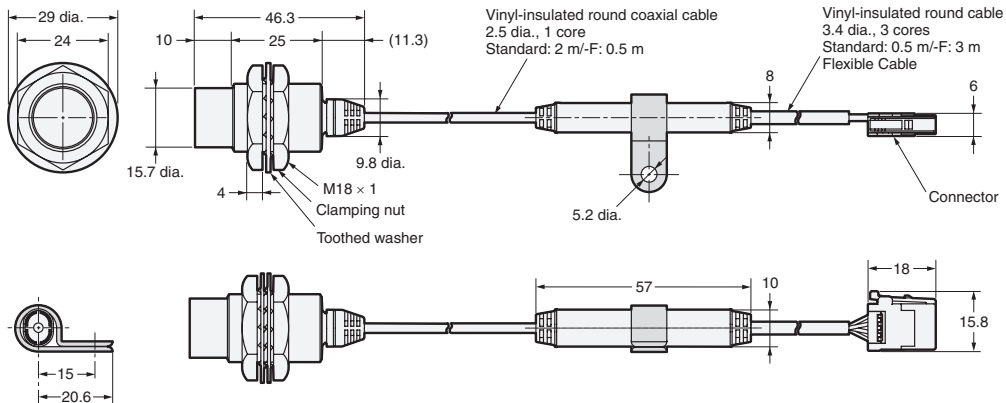

E2C-EV05(-F)

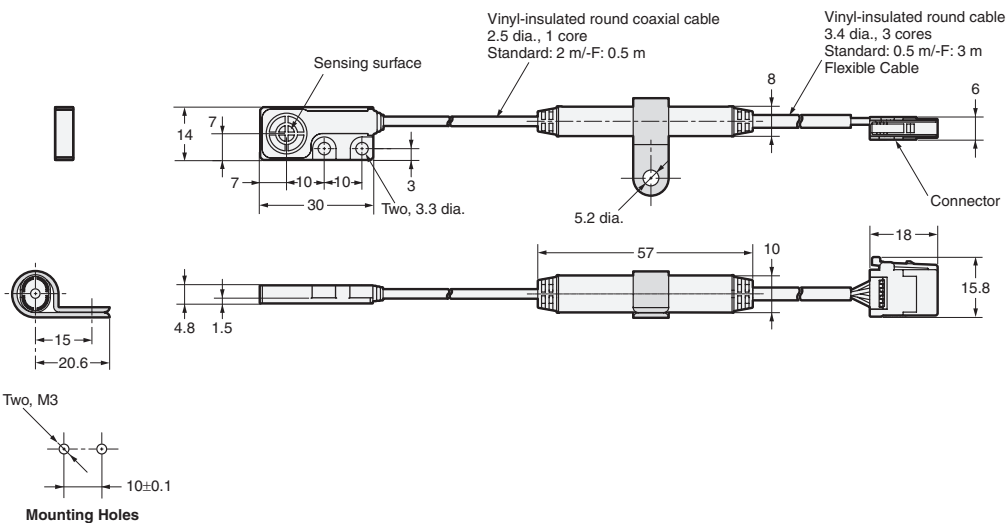

Mounting Holes

E2C-EM02H

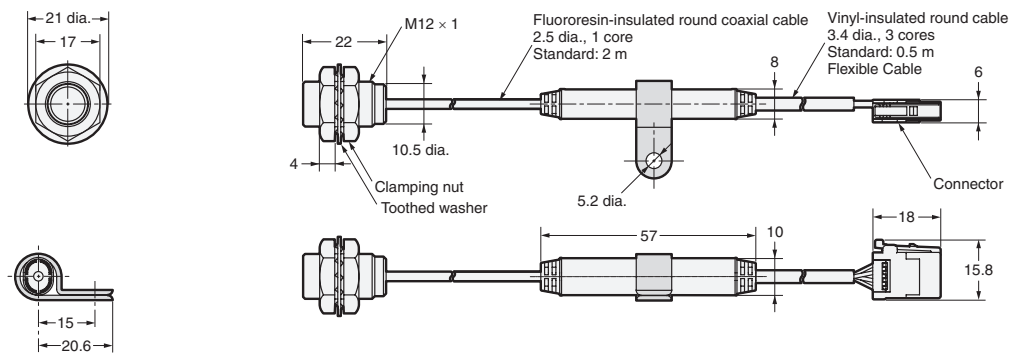

E22-XC2R E22-XC7R

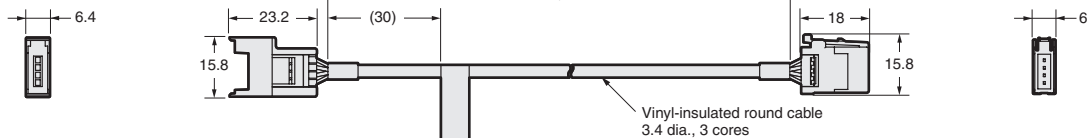

* Cable Specifications

Specifications	L
2 m	2,000 ⁺⁵⁰ ₀
7 m	7,000 ⁺²⁰⁰ ₀

Amplifier Units

Amplifier Units with Cables

- E2C-EDA11
- E2C-EDA21
- E2C-EDA41
- E2C-EDA51

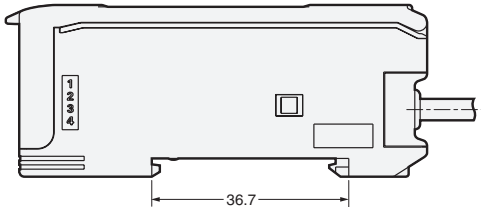
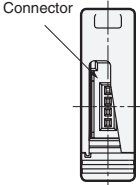
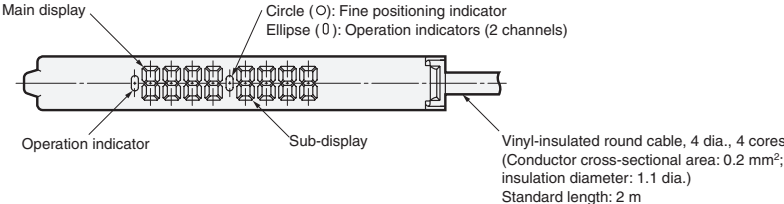

With Mounting Bracket Attached

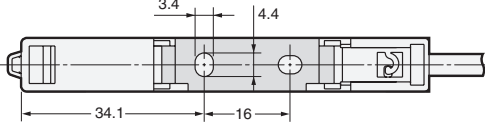
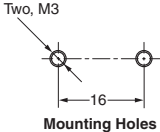
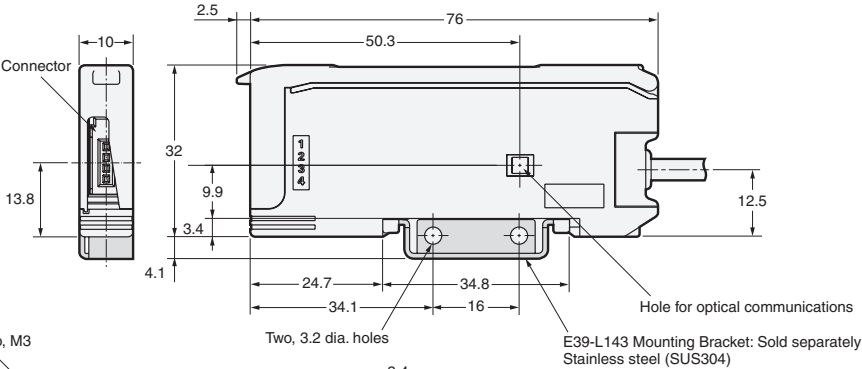
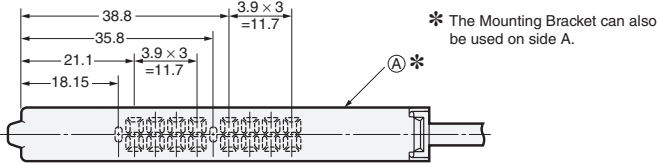

Amplifier Units with Connectors

- E2C-EDA6
- E2C-EDA7
- E2C-EDA8
- E2C-EDA9

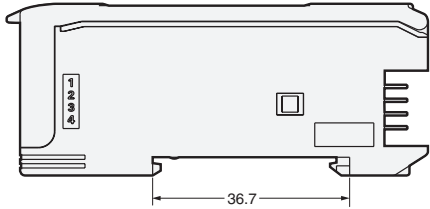
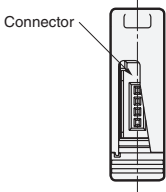
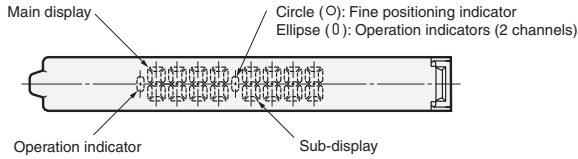

With Mounting Bracket Attached

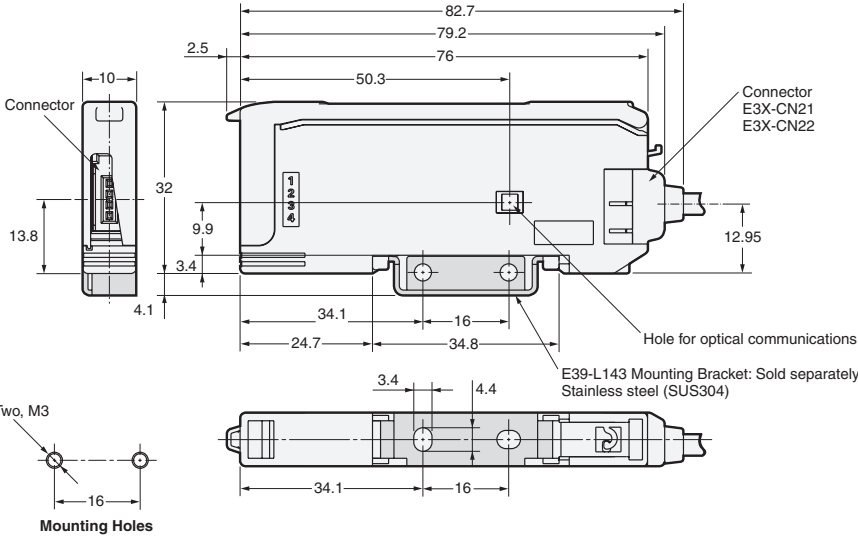
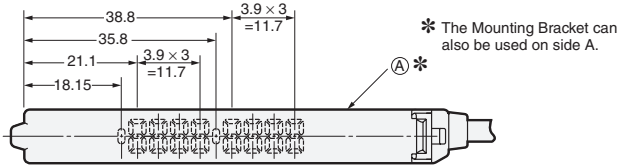

Amplifier Unit Connectors

Refer to E3X-DA-S/MDA for details.

Mobile Console

Refer to E3X-DA-S/MDA for details.

Accessories (Order Separately)

Mounting Brackets

Refer to E39-L/F39-L for details.

End Plate

Refer to DIN rail for details.

Read and Understand This Catalog

Please read and understand this catalog before purchasing the products. Please consult your OMRON representative if you have any questions or comments.

Warranty and Limitations of Liability

WARRANTY

OMRON's exclusive warranty is that the products are free from defects in materials and workmanship for a period of one year (or other period if specified) from date of sale by OMRON.

OMRON MAKES NO WARRANTY OR REPRESENTATION, EXPRESS OR IMPLIED, REGARDING NON-INFRINGEMENT, MERCHANTABILITY, OR FITNESS FOR PARTICULAR PURPOSE OF THE PRODUCTS. ANY BUYER OR USER ACKNOWLEDGES THAT THE BUYER OR USER ALONE HAS DETERMINED THAT THE PRODUCTS WILL SUITABLY MEET THE REQUIREMENTS OF THEIR INTENDED USE. OMRON DISCLAIMS ALL OTHER WARRANTIES, EXPRESS OR IMPLIED.

LIMITATIONS OF LIABILITY

OMRON SHALL NOT BE RESPONSIBLE FOR SPECIAL, INDIRECT, OR CONSEQUENTIAL DAMAGES, LOSS OF PROFITS OR COMMERCIAL LOSS IN ANY WAY CONNECTED WITH THE PRODUCTS, WHETHER SUCH CLAIM IS BASED ON CONTRACT, WARRANTY, NEGLIGENCE, OR STRICT LIABILITY.

In no event shall the responsibility of OMRON for any act exceed the individual price of the product on which liability is asserted.

IN NO EVENT SHALL OMRON BE RESPONSIBLE FOR WARRANTY, REPAIR, OR OTHER CLAIMS REGARDING THE PRODUCTS UNLESS OMRON'S ANALYSIS CONFIRMS THAT THE PRODUCTS WERE PROPERLY HANDLED, STORED, INSTALLED, AND MAINTAINED AND NOT SUBJECT TO CONTAMINATION, ABUSE, MISUSE, OR INAPPROPRIATE MODIFICATION OR REPAIR.

Application Considerations

SUITABILITY FOR USE

OMRON shall not be responsible for conformity with any standards, codes, or regulations that apply to the combination of products in the customer's application or use of the products.

At the customer's request, OMRON will provide applicable third party certification documents identifying ratings and limitations of use that apply to the products. This information by itself is not sufficient for a complete determination of the suitability of the products in combination with the end product, machine, system, or other application or use.

The following are some examples of applications for which particular attention must be given. This is not intended to be an exhaustive list of all possible uses of the products, nor is it intended to imply that the uses listed may be suitable for the products:

- Outdoor use, uses involving potential chemical contamination or electrical interference, or conditions or uses not described in this catalog.
- Nuclear energy control systems, combustion systems, railroad systems, aviation systems, medical equipment, amusement machines, vehicles, safety equipment, and installations subject to separate industry or government regulations.
- Systems, machines, and equipment that could present a risk to life or property.

Please know and observe all prohibitions of use applicable to the products.

NEVER USE THE PRODUCTS FOR AN APPLICATION INVOLVING SERIOUS RISK TO LIFE OR PROPERTY WITHOUT ENSURING THAT THE SYSTEM AS A WHOLE HAS BEEN DESIGNED TO ADDRESS THE RISKS, AND THAT THE OMRON PRODUCTS ARE PROPERLY RATED AND INSTALLED FOR THE INTENDED USE WITHIN THE OVERALL EQUIPMENT OR SYSTEM.

PROGRAMMABLE PRODUCTS

OMRON shall not be responsible for the user's programming of a programmable product, or any consequence thereof.

Disclaimers

CHANGE IN SPECIFICATIONS

Product specifications and accessories may be changed at any time based on improvements and other reasons.

It is our practice to change model numbers when published ratings or features are changed, or when significant construction changes are made. However, some specifications of the products may be changed without any notice. When in doubt, special model numbers may be assigned to fix or establish key specifications for your application on your request. Please consult with your OMRON representative at any time to confirm actual specifications of purchased products.

DIMENSIONS AND WEIGHTS

Dimensions and weights are nominal and are not to be used for manufacturing purposes, even when tolerances are shown.

PERFORMANCE DATA

Performance data given in this catalog is provided as a guide for the user in determining suitability and does not constitute a warranty. It may represent the result of OMRON's test conditions, and the users must correlate it to actual application requirements. Actual performance is subject to the OMRON Warranty and Limitations of Liability.

ERRORS AND OMISSIONS

The information in this document has been carefully checked and is believed to be accurate; however, no responsibility is assumed for clerical, typographical, or proofreading errors, or omissions.

2011.9

In the interest of product improvement, specifications are subject to change without notice.

OMRON Corporation
Industrial Automation Company

<http://www.ia.omron.com/>

(c)Copyright OMRON Corporation 2011 All Right Reserved.