

## Surface Mount Super Fast Recovery Rectifier

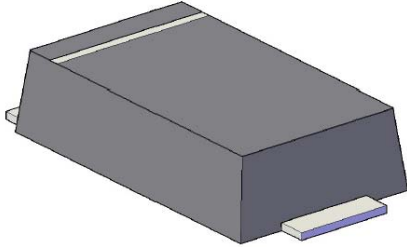

### Features

- Low profile package
- Ideal for automated placement
- Glass passivated chip junction
- High forward surge capability
- Super Fast reverse recovery time
- Meets MSL level 1, per J-STD-020, LF maximum peak of 260 °C

### Typical Applications

For use in high frequency rectification of power supplies, inverters, converters, and freewheeling diodes for consumer, and telecommunication.

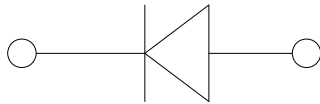

### Mechanical Data

- **Package:** SOD-123HE  
Molding compound meets UL 94 V-0 flammability rating, RoHS-compliant, halogen-free
- **Terminals:** Tin plated leads, solderable per J-STD-002 and JESD22-B102
- **Polarity:** Cathode line denotes the cathode end

### ■ Maximum Ratings ( $T_a=25^\circ\text{C}$ Unless otherwise specified)

PARAMETER	SYMBOL	UNIT	E2AE	E2BE	E2CE	E2DE	E2FE	E2GE	E2HE	E2JE	E2KE
Device marking code			E2AE	E2BE	E2CE	E2DE	E2FE	E2GE	E2HE	E2JE	E2KE
Maximum Repetitive Peak Reverse Voltage	$V_{RRM}$	V	50	100	150	200	300	400	500	600	800
Maximum RMS Voltage	$V_{RMS}$	V	35	70	105	140	210	280	350	420	560
Maximum DC blocking Voltage	$V_{DC}$	V	50	100	150	200	300	400	500	600	800
Average rectified output current @60Hz sine wave, resistance load, TL (Fig.1)	$I_o$	A	2.0								
Forward Surge Current (Non-repetitive) @60Hz Half-sine wave, 1 cycle, $T_j=25^\circ\text{C}$	$I_{FSM}$	A	50								
Forward Surge Current (Non-repetitive) @1ms, square wave, 1 cycle, $T_j=25^\circ\text{C}$			100								
Current squared time @1ms≤t≤8.3ms $T_j=25^\circ\text{C}$	$I^2t$	$A^2s$	10.375								
Storage temperature	$T_{stg}$	$^\circ\text{C}$	-55 ~ +150								
Junction temperature	$T_j$	$^\circ\text{C}$	-55 ~ +150								



# E2AE THRU E2KE

## ■ Electrical Characteristics (T<sub>a</sub>=25°C Unless otherwise specified)

PARAMETER	SYMBOL	UNIT	TEST CONDITIONS	E2AE	E2BE	E2CE	E2DE	E2FE	E2GE	E2HE	E2JE	E2KE
Maximum instantaneous forward voltage	V <sub>F</sub>	V	I <sub>FM</sub> =2.0A	1.0				1.3	1.7		1.85	
Maximum reverse recovery time	t <sub>rr</sub>	ns	I <sub>F</sub> =0.5A, I <sub>R</sub> =1.0A, I <sub>rr</sub> =0.25A	35								
Maximum DC reverse current at rated DC blocking voltage	I <sub>R</sub>	μA	T <sub>j</sub> =25°C	5.0								
			T <sub>j</sub> =125°C	100								
Typical junction capacitance	C <sub>j</sub>	pF	Measured at 1MHz and Applied Reverse Voltage of 4.0 V.D.C	30			16	12		12		

## ■ Thermal Characteristics (T<sub>a</sub>=25°C Unless otherwise specified)

PARAMETER	SYMBOL	UNIT	E2AE	E2BE	E2CE	E2DE	E2FE	E2GE	E2HE	E2JE	E2KE
Typical Thermal resistance	R <sub>θJ-A</sub> <sup>(1)</sup>	°C/W	90								
	R <sub>θJ-L</sub> <sup>(1)</sup>		30								

Note:  
 (1) Thermal resistance from junction to ambient and from junction to lead mounted on P.C.B. with 0.2" x 0.2" (5.0 mm x 5.0 mm) copper pad areas

## ■ Characteristics (Typical)

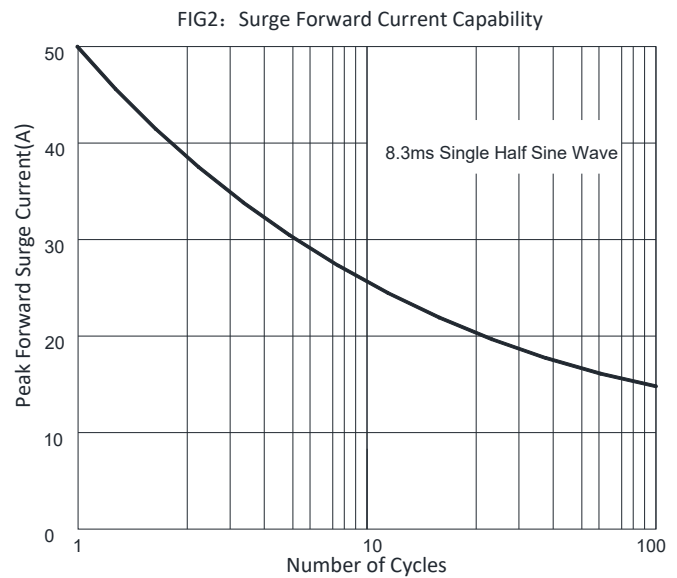
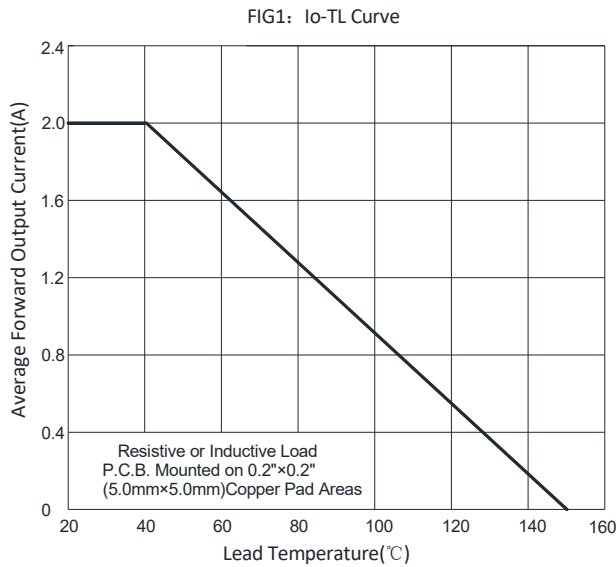



# E2AE THRU E2KE

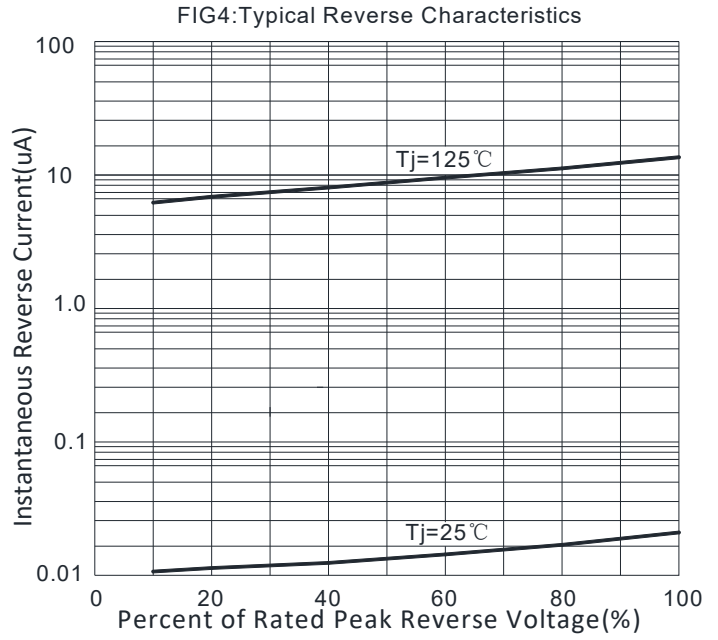
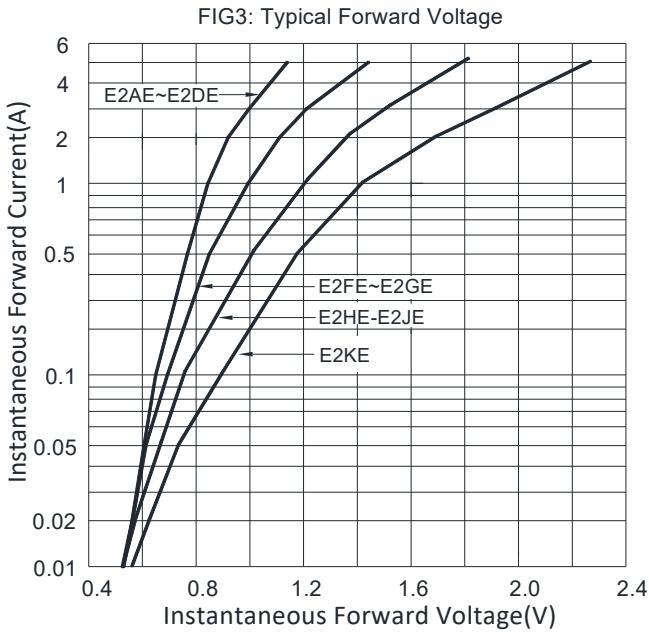
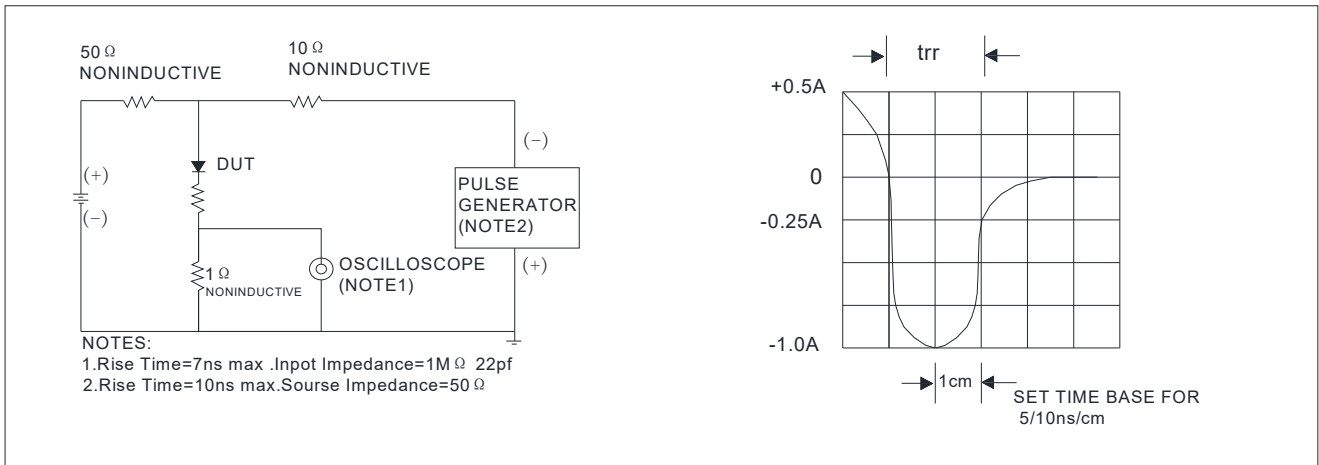

FIG.5: Diagram of circuit and Testing wave form of reverse recovery time





## E2AE THRU E2KE

### ■ Outline Dimensions

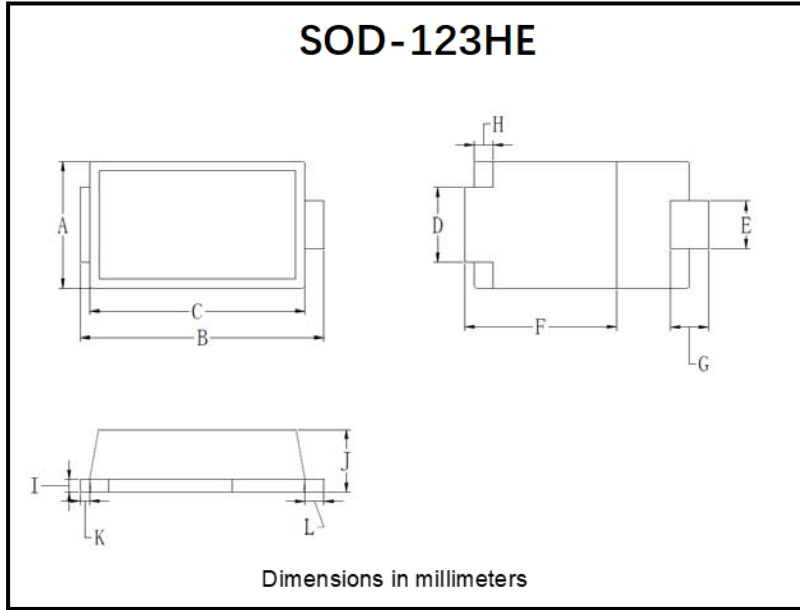

SOD-123HE		
Dim	Min	Max
A	1.88	2.18
B	3.70	4.00
C	3.19	3.61
D	1.05	1.35
E	0.61	0.91
F	2.20	2.90
G	0.40	0.80
H	0.30 TYP	
I	0.10	0.30
J	0.85	1.15
K	0.00	0.30
L	0.15	0.45

### ■ Suggested pad layout

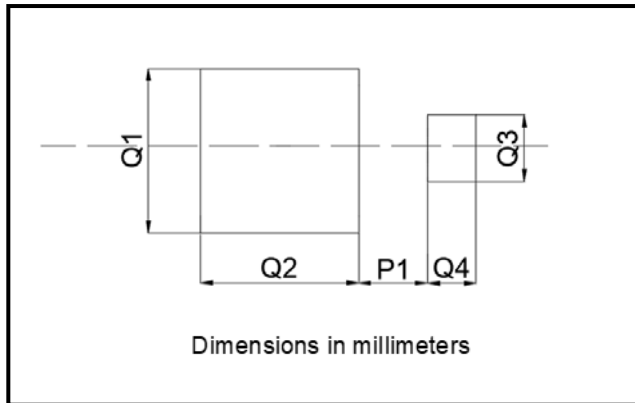

SOD-123HE	
Dim	Millimeters
P1	0.64
Q1	2.54
Q2	2.67
Q3	1.27
Q4	0.76



## E2AE THRU E2KE

---

### Disclaimer

The information presented in this document is for reference only. Yangzhou Yangjie Electronic Technology Co., Ltd. reserves the right to make changes without notice for the specification of the products displayed herein to improve reliability, function or design or otherwise.

The product listed herein is designed to be used with ordinary electronic equipment or devices, and not designed to be used with equipment or devices which require high level of reliability and the malfunction of which would directly endanger human life (such as medical instruments, transportation equipment, aerospace machinery, nuclear-reactor controllers, fuel controllers and other safety devices), Yangjie or anyone on its behalf, assumes no responsibility or liability for any damages resulting from such improper use of sale.

This publication supersedes & replaces all information previously supplied. For additional information, please visit our website [http:// www.21yangjie.com](http://www.21yangjie.com) , or consult your nearest Yangjie's sales office for further assistance.