

# DELPHI SERIES



## FEATURES

- ◆ High efficiency: 96.5% @ 9.6V/25A
- ◆ Size: 58.4mm x 22.8mm x 11.3mm  
(2.28" x 0.90" x 0.44")
- ◆ Industry standard pinout
- ◆ Fully protected: Input UVLO, OVP, Output OCP and OTP
- ◆ 240W constant power output
- ◆ Parallelable for higher output power
- ◆ 2250V isolation
- ◆ Basic insulation
- ◆ Monotonic startup
- ◆ No minimum load required
- ◆ ISO 9001, TL 9000, ISO 14001, QS9000, OHSAS18001 certified manufacturing facility
- ◆ UL/cUL 60950 (US & Canada) Recognized, and TUV (EN60950) Certified
- ◆ CE mark meets 73/23/EEC and 93/68/EEC directives

## Delphi Series E48SB, 240W Eighth Brick Bus Converter DC/DC Power Modules: 48Vin, 9.6V/25A out

Delta Electronics, Inc., a world leader in power systems technology and manufacturing, has introduced the E48SB, eighth brick sized 240W bus converter, into their Delphi Series of board mounted DC/DC power converters to support the intermediate bus architecture to power multiple downstream non-isolated point-of-load (POL) converters. The E48SB product family features an input voltage of 38V to 55V, and provides up to 240W (9.6V and above) of power in an industry standard eighth brick footprint. Typical efficiency of 9.6V module is 96.5%. With optimized component placement, creative design topology, and numerous patented technologies, the E48SB bus converters deliver outstanding electrical and thermal performance. An optional heatsink is available for harsh thermal requirements.

## OPTIONS

- ◆ Positive On/Off logic
- ◆ Short pin lengths
- ◆ Heatsink available for extended operation
- ◆ OTP and OCP mode (Auto re-restart or latch)

## APPLICATIONS

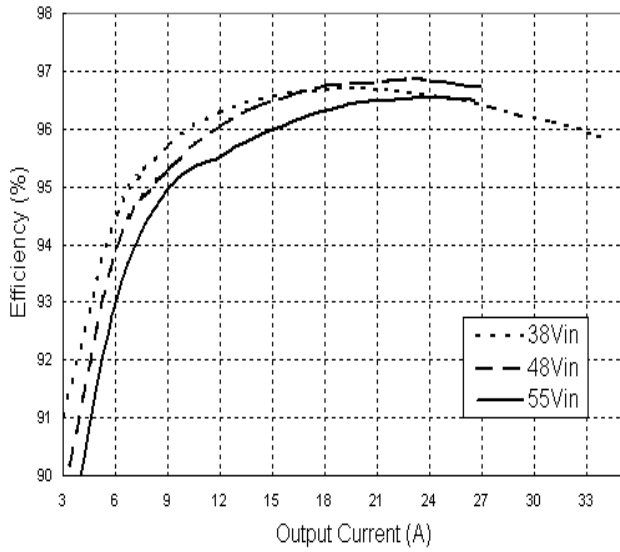
- ◆ Datacom / Networking
- ◆ Wireless Networks
- ◆ Optical Network Equipment
- ◆ Server and Data Storage
- ◆ Industrial/Testing Equipment

# TECHNICAL SPECIFICATIONS

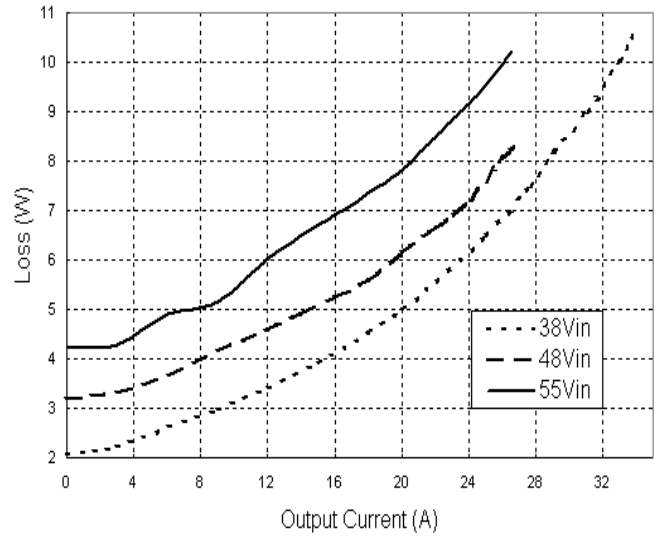
( $T_A=25^{\circ}\text{C}$ , airflow rate=300 LFM,  $V_{in}=48\text{Vdc}$ , nominal  $V_{out}$  unless otherwise noted.)

PARAMETER	NOTES and CONDITIONS	E48SB9R625 (Standard)			
		Min.	Typ.	Max.	Units
<b>ABSOLUTE MAXIMUM RATINGS</b>					
Input Voltage					
Continuous				60	Vdc
Operating Temperature	Refer to Figure 17 for the measuring point, Tc	-40		117	$^{\circ}\text{C}$
Storage Temperature		-55		125	$^{\circ}\text{C}$
Input/Output Isolation Voltage				2250	Vdc
<b>INPUT CHARACTERISTICS</b>					
Operating Input Voltage		38	48	55	Vdc
Input Under-Voltage Lockout					
Turn-On Voltage Threshold		35	36.5	38	Vdc
Turn-Off Voltage Threshold		33	34.5	36	Vdc
Lockout Hysteresis Voltage		1	2	3	Vdc
Input Over-Voltage Lockout					
Turn-Off Voltage Threshold		58	60	62	Vdc
Turn-On Voltage Threshold		57	58.5	60	Vdc
Lockout Hysteresis Voltage		1	1.5	2.5	Vdc
Maximum Input Current	38V $V_{in}$ , 100% Load			6.65	A
No-Load Input Current			80	120	mA
Off Converter Input Current			7	15	mA
Inrush Current ( $I^2t$ )				0.03	$\text{A}^2\text{s}$
Input Reflected-Ripple Current	P-P thru 12 $\mu\text{H}$ inductor, 5Hz to 20MHz		15	25	mA
<b>OUTPUT CHARACTERISTICS</b>					
Output Voltage Set Point	$V_{in}=48\text{V}$ , $I_o=\text{no load}$ , $T_a=25^{\circ}\text{C}$		9.5		Vdc
Output Voltage Regulation					
Over Load	$I_o=I_{o,\text{min}}$ to $I_{o,\text{max}}$		300	400	mV
Over Line	$V_{in}=38\text{V}$ to $55\text{V}$		3.4	3.6	V
Over Temperature	$T_c=-40^{\circ}\text{C}$ to $100^{\circ}\text{C}$			200	mV
Total Output Voltage Range	Over sample load, line and temperature	7.0		11	V
Output Voltage Ripple and Noise	5Hz to 20MHz bandwidth				
Peak-to-Peak	Full Load, 1 $\mu\text{F}$ ceramic, 10 $\mu\text{F}$ tantalum		100	150	mV
RMS	Full Load, 1 $\mu\text{F}$ ceramic, 10 $\mu\text{F}$ tantalum		25	40	mV
Operating Output Power Range	Full input voltage range	0		240	W
Output DC Power-Limit Inception	Full input voltage range	110%		140%	W
Current share accuracy (2 units in parallel)	% of rated output current		10		%
<b>DYNAMIC CHARACTERISTICS</b>					
Output Voltage Current Transient	48V, 10 $\mu\text{F}$ Tan & 1 $\mu\text{F}$ Ceramic load cap, 0.1A/ $\mu\text{s}$				
Positive Step Change in Output Current	50% $I_{o,\text{max}}$ to 75% $I_{o,\text{max}}$		80	150	mV
Negative Step Change in Output Current	75% $I_{o,\text{max}}$ to 50% $I_{o,\text{max}}$		80	150	mV
Settling Time (within 1% $V_{out}$ nominal)			90	120	us
Turn-On Transient					
Start-Up Time, From On/Off Control		8	15	25	ms
Start-Up Time, From Input		15	20	30	ms
Maximum Output Capacitance				3000	$\mu\text{F}$
<b>EFFICIENCY</b>					
100% Load	$V_{in}=48\text{V}$		96.5		%
60% Load	$V_{in}=48\text{V}$		96.0		%
<b>ISOLATION CHARACTERISTICS</b>					
Input to Output				2250	Vdc
Isolation Resistance			10		$\text{M}\Omega$
Isolation Capacitance			1000		pF
<b>FEATURE CHARACTERISTICS</b>					
Switching Frequency			130		kHz
ON/OFF Control, Negative Remote On/Off logic					
Logic Low (Module On)	$V_{on/off}$	-0.7		0.8	V
Logic High (Module Off)	$V_{on/off}$	2		18	V
ON/OFF Control, Positive Remote On/Off logic					
Logic Low (Module Off)	$V_{on/off}$	-0.7		0.8	V
Logic High (Module On)	$V_{on/off}$	2		18	V
ON/OFF Current (for both remote on/off logic)	$I_{on/off}$ at $V_{on/off}=0.0\text{V}$		0.25	0.3	mA
Leakage Current (for both remote on/off logic)	Logic High, $V_{on/off}=15\text{V}$			30	uA
<b>GENERAL SPECIFICATIONS</b>					
MTBF	$I_o=80\%$ of $I_{o,\text{max}}$ ; $T_a=25^{\circ}\text{C}$		1.86		M hours
Weight			31.76		grams
Over-Temperature Shutdown	Refer to Figure 17 for the measuring point, Tc		122		$^{\circ}\text{C}$

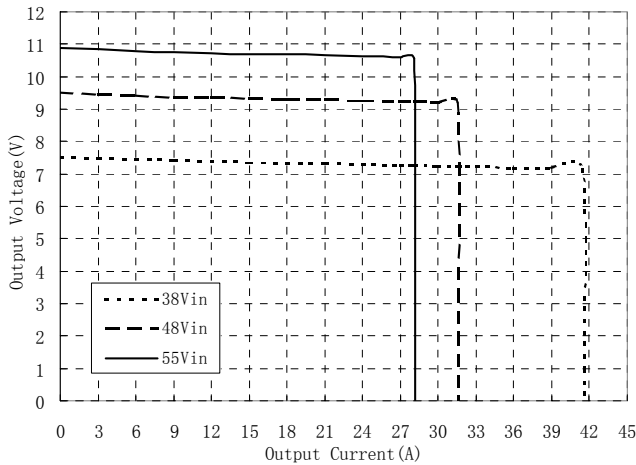
# ELECTRICAL CHARACTERISTICS CURVES



**Figure 1:** Efficiency vs. load current for minimum, nominal, and maximum input voltage at 25°C



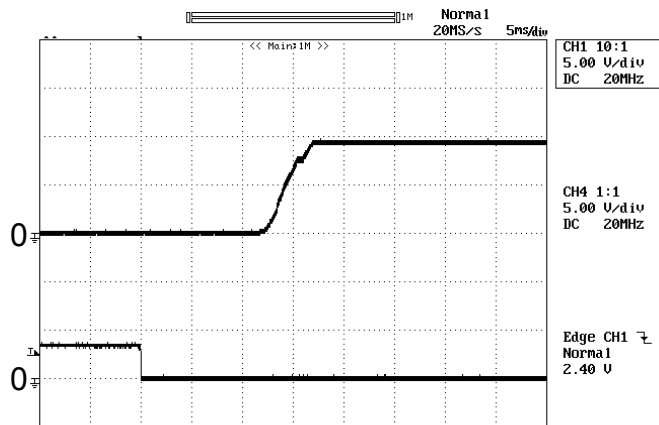
**Figure 2:** Power loss vs. load current for minimum, nominal, and maximum input voltage at 25°C.



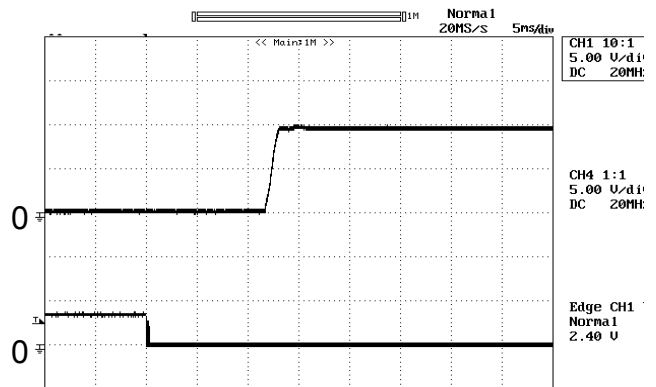
**Figure 3:** Output voltage regulation vs load current showing typical current limit curves and converter shutdown points for minimum, nominal, and maximum input voltage at room temperature .

# ELECTRICAL CHARACTERISTICS CURVES

## For Negative Remote On/Off Turn on Waveform

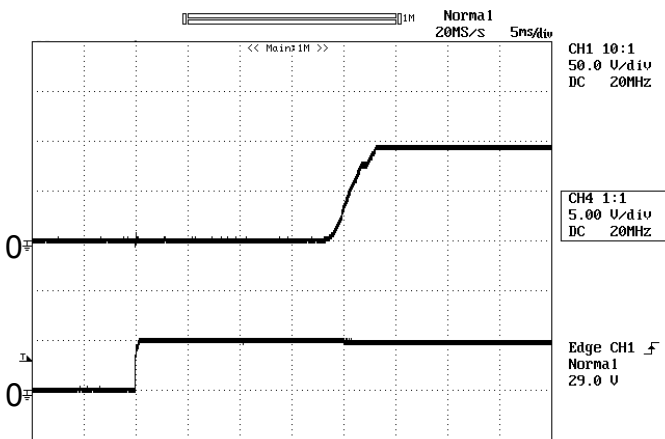


**Figure 4:** Turn-on transient at full rated load current (5 ms/div). Top Trace: Vout; 5V/div; Bottom Trace: ON/OFF input: 2V/div

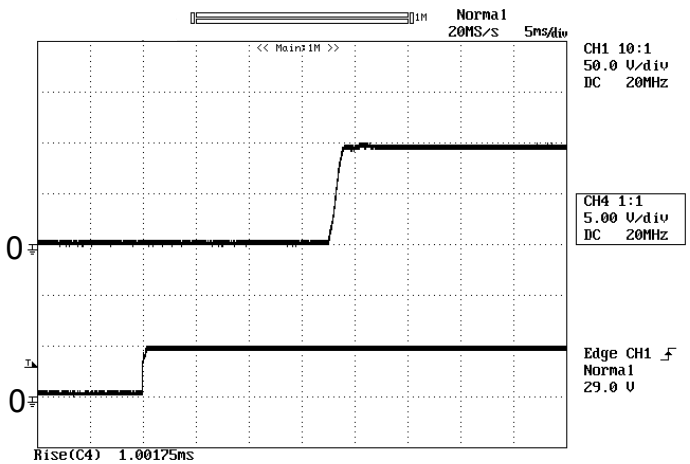


**Figure 5:** Turn-on transient at zero load current (5 ms/div). Top Trace: Vout: 5V/div; Bottom Trace: ON/OFF input: 2V/div

## For Vin Input Turn on Waveform

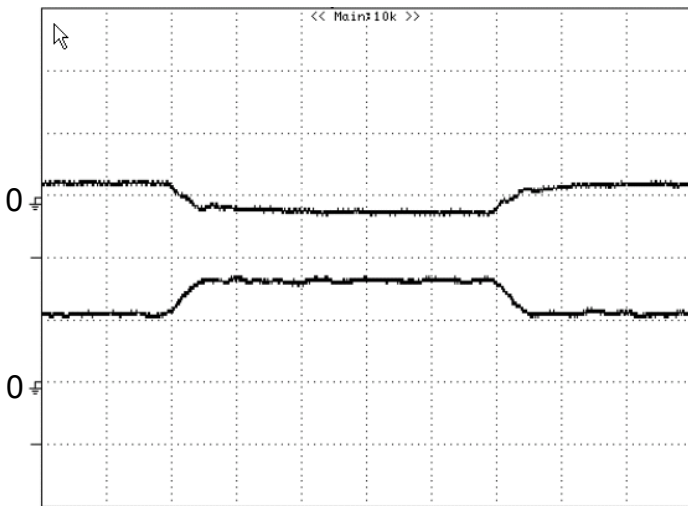


**Figure 6:** Turn-on transient at full rated load current (5 ms/div). Top Trace: Vout; 5V/div; Bottom Trace: Vin; 50V/div.

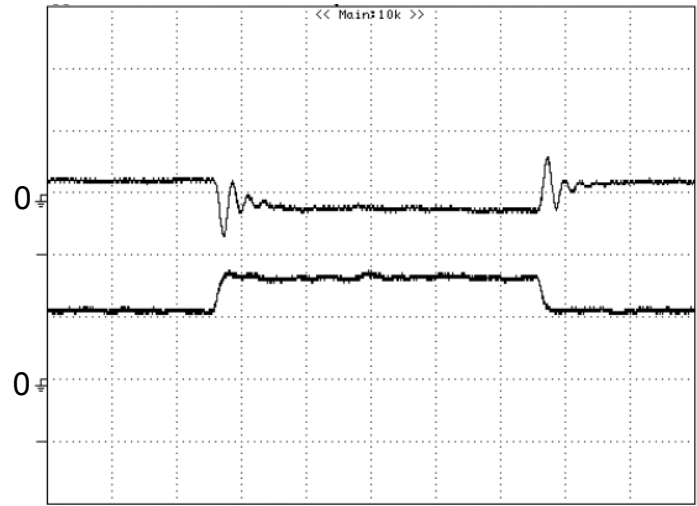


**Figure 7:** Turn-on transient at zero load current (5 ms/div). Top Trace: Vout: 5V/div; Bottom Trace: Vin; 50V/div.

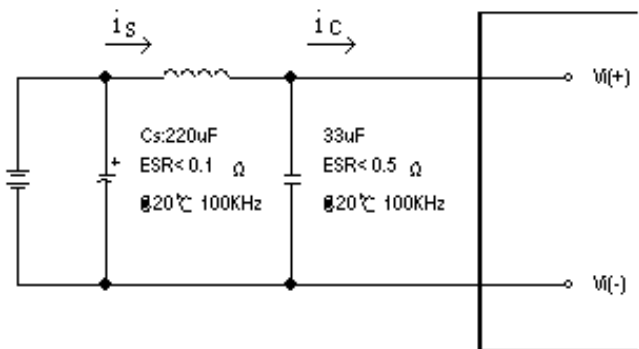
## ELECTRICAL CHARACTERISTICS CURVES



**Figure 8:** Output voltage response to step-change in load current (50%-75%-50% of  $I_{o,max}$ ;  $di/dt = 0.1A/\mu s$ ). Load cap:  $10\mu F$ , tantalum capacitor and  $1\mu F$  ceramic capacitor. Top Trace:  $V_{out}$  (100mV/div, 100us/div), Bottom Trace:  $I_{out}$  (10A/div). Scope measurement should be made using a BNC cable (length shorter than 20 inches). Position the load between 51 mm to 76 mm (2 inches to 3 inches) from the module.



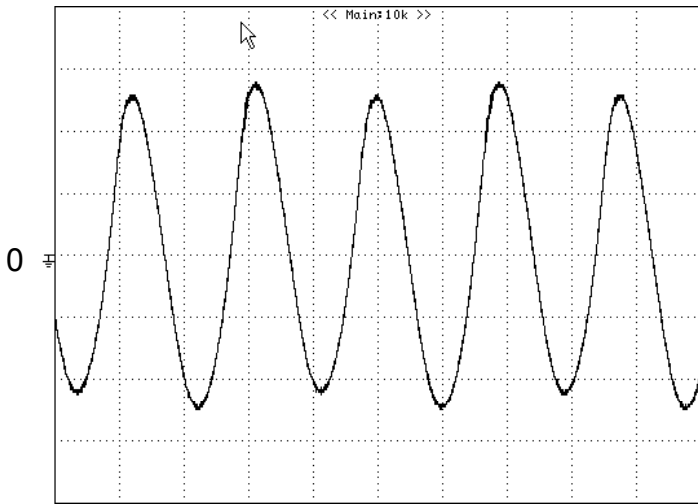
**Figure 9:** Output voltage response to step-change in load current (50%-75%-50% of  $I_{o,max}$ ;  $di/dt = 1A/\mu s$ ). Load cap:  $10\mu F$ , tantalum capacitor and  $1\mu F$  ceramic capacitor. Top Trace:  $V_{out}$  (200mV/div, 100us/div), Bottom Trace:  $I_{out}$  (5A/div). Scope measurement should be made using a BNC cable (length shorter than 20 inches). Position the load between 51 mm to 76 mm (2 inches to 3 inches) from the module.



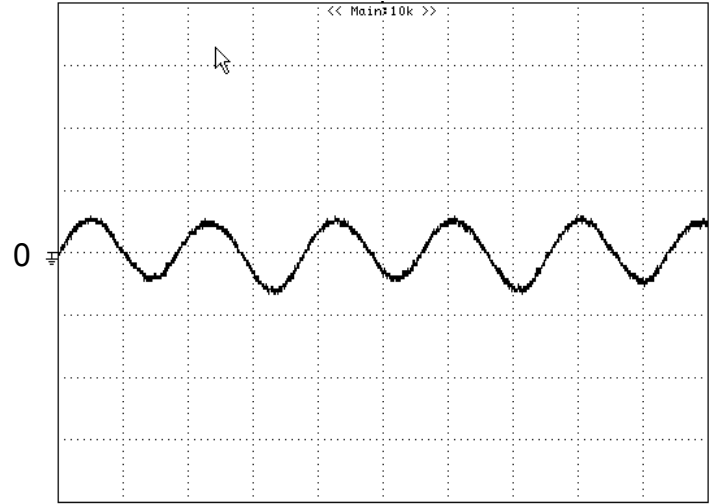
**Figure 10:** Test set-up diagram showing measurement points for Input Terminal Ripple Current and Input Reflected Ripple Current.

Note: Measured input reflected-ripple current with a simulated source Inductance ( $L_{TEST}$ ) of  $12\mu H$ . Capacitor  $C_s$  offset possible battery impedance. Measure current as shown below

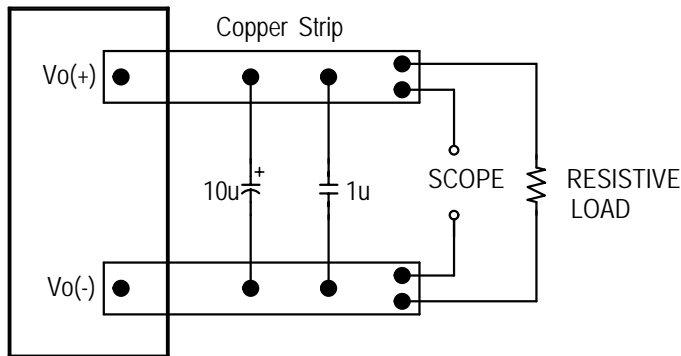
## ELECTRICAL CHARACTERISTICS CURVES



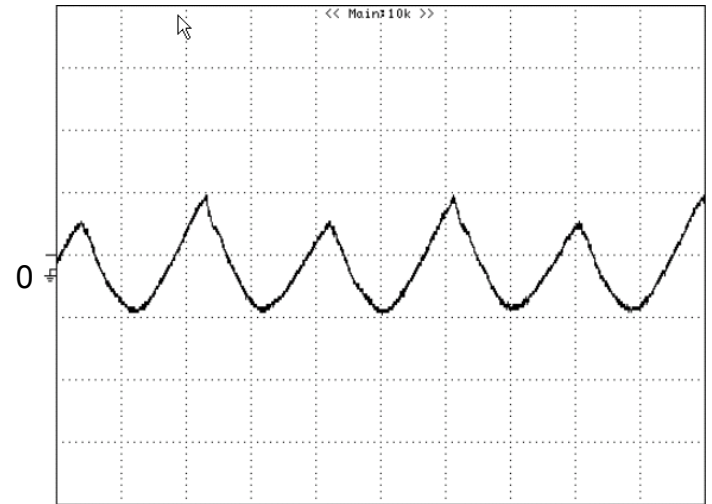
**Figure 11:** Input Terminal Ripple Current,  $i_c$ , at full rated output current and nominal input voltage with  $10\mu\text{H}$  source impedance and  $47\mu\text{F}$  electrolytic capacitor (200 mA/div, 2 us/div).



**Figure 12:** Input reflected ripple current,  $i_s$ , through a  $10\mu\text{H}$  source inductor at nominal input voltage and rated load current (20 mA/div, 2 us/div).



**Figure 13:** Output voltage noise and ripple measurement test setup.



**Figure 14:** Output voltage ripple at nominal input voltage and rated load current (50 mV/div, 2 us/div). Load capacitance:  $1\mu\text{F}$  ceramic capacitor and  $10\mu\text{F}$  tantalum capacitor. Bandwidth: 20 MHz. Scope measurement should be made using a BNC cable (length shorter than 20 inches). Position the load between 51 mm to 76 mm (2 inches to 3 inches) from the module.



## DESIGN CONSIDERATIONS

### Input Source Impedance

The impedance of the input source connecting to the DC/DC power modules will interact with the modules and affect the stability. A low ac-impedance input source is recommended. If the source inductance is more than a few  $\mu\text{H}$ , we advise adding a 33 to 220 $\mu\text{F}$  electrolytic capacitor (ESR < 0.5  $\Omega$  at 100 kHz) mounted close to the input of the module to improve the stability.

### Layout and EMC Considerations

Delta's DC/DC power modules are designed to operate in a wide variety of systems and applications. For design assistance with EMC compliance and related PWB layout issues, please contact Delta's technical support team. An external input filter module is available for easier EMC compliance design. Application notes to assist designers in addressing these issues are pending release.

### Soldering and Cleaning Considerations

Post solder cleaning is usually the final board assembly process before the board or system undergoes electrical testing. Inadequate cleaning and/or drying may lower the reliability of a power module and severely affect the finished circuit board assembly test. Adequate cleaning and/or drying is especially important for un-encapsulated and/or open frame type power modules. For assistance on appropriate soldering and cleaning procedures, please contact Delta's technical support team.

## FEATURES DESCRIPTIONS

### Over-Current Protection

The modules include an internal output over-current protection circuit, which will endure current limiting for an unlimited duration during output overload. If the output current exceeds the OCP set point, the modules will automatically shut down, and enter hiccup mode or latch mode, which is optional.

For hiccup mode, the module will try to restart after shutdown. If the overload condition still exists, the module will shut down again. This restart trial will continue until the overload condition is corrected.

For latch mode, the module will latch off once it shutdown. The latch is reset by either cycling the input power or by toggling the on/off signal for one second.

### Over-Temperature Protection

The over-temperature protection consists of circuitry that provides protection from thermal damage. If the temperature exceeds the over-temperature threshold the module will shut down, and enter in auto-restart mode or latch mode, which is optional.

For auto-restart mode, the module will monitor the module temperature after shutdown. Once the temperature is within the specification, the module will be auto-restart.

For latch mode, the module will latch off once it shutdown. The latch is reset by either cycling the input power or by toggling the on/off signal for one second.

### Remote On/Off

The remote on/off feature on the module can be either negative or positive logic. Negative logic turns the module on during a logic low and off during a logic high. Positive logic turns the modules on during a logic high and off during a logic low.

Remote on/off can be controlled by an external switch between the on/off terminal and the  $V_i(-)$  terminal. The switch can be an open collector or open drain.

For negative logic if the remote on/off feature is not used, please short the on/off pin to  $V_i(-)$ . For positive logic if the remote on/off feature is not used, please leave the on/off pin floating.

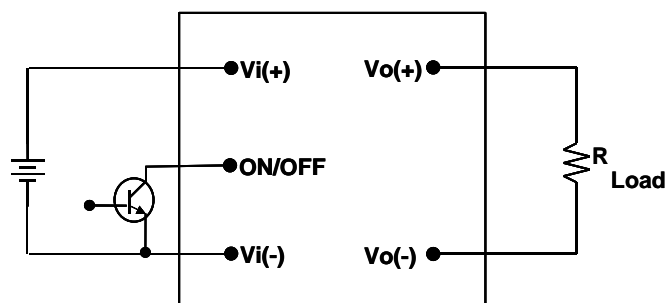


Figure 15: Remote on/off implementation

## DESIGN CONSIDERATIONS

### Current Sharing

The modules are capable of operating in parallel without any external current sharing circuitry.

For a normal parallel operation, the following precautions must be observed:

1. The current sharing accuracy calculation equation is:

$$\text{Current sharing accuracy} = ((I_{\text{load}}/n) - I) * 100\% / I_{\text{rated}}$$

Where,  $I_{\text{load}}$  = Total load current;

$I$  = Output current of per converter;

$I_{\text{rated}}$  = Converter's rated output current at different  $V_{\text{in}}$ ;

$n$  = the number of parallel modules

2. The maximum load current for N converters is

$$I_{\text{max}} = (1 - X\%) * N * I_{\text{rated}}$$

Where, X% is current sharing load accuracy.

$I_{\text{rated}}$  is 100% load for different  $V_{\text{in}}$

This unit has been tested with up to 2 units in parallel.

3. To ensure a better steady current sharing accuracy, below design guideline should be followed:
  - a) The inputs of the converters must be connected to the same voltage source
  - b) The PCB trace resistance from Input voltage source to  $V_{\text{in+}}$  and  $V_{\text{in-}}$  of each converter should be as equalize as possible.
  - c) The PCB trace resistance from each converter's output to the load should be equalized as much as possible.
4. To ensure a better transient current sharing, and the monotonic startup of the parallel module
  - a) The ON/OFF pin of the converters should be connected together to keep the parallel modules start up at the approximately same time.
  - b) The under voltage lockout point will slightly vary from unit to unit. The  $dv/dt$  of the rising edge of the input source voltage must be greater than 1V/ms to ensure that the parallel can start up at the approximately same time.



## THERMAL CONSIDERATIONS

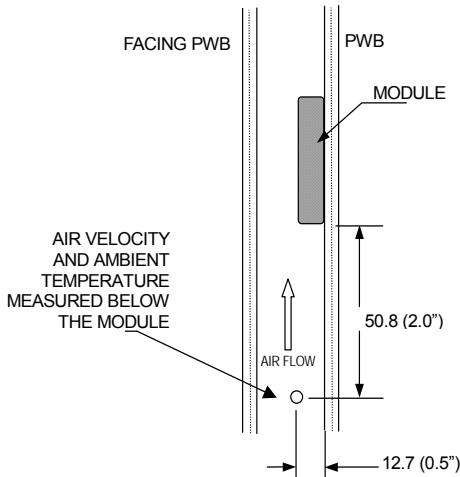
Thermal management is an important part of the system design. To ensure proper, reliable operation, sufficient cooling of the power module is needed over the entire temperature range of the module. Convection cooling is usually the dominant mode of heat transfer.

Hence, the choice of equipment to characterize the thermal performance of the power module is a wind tunnel.

### Thermal Testing Setup

Delta's DC/DC power modules are characterized in heated vertical wind tunnels that simulate the thermal environments encountered in most electronics equipment. This type of equipment commonly uses vertically mounted circuit cards in cabinet racks in which the power modules are mounted.

The following figure shows the wind tunnel characterization setup. The power module is mounted on a test PWB and is vertically positioned within the wind tunnel. The space between the neighboring PWB and the top of the power module is constantly kept at 6.35mm (0.25").



Note: Wind Tunnel Test Setup Figure Dimensions are in millimeters and (Inches)

Figure 16: Wind tunnel test setup

### Thermal Derating

Heat can be removed by increasing airflow over the module. To enhance system reliability, the power module should always be operated below the maximum operating temperature. If the temperature exceeds the maximum module temperature, reliability of the unit may be affected.

## THERMAL CURVES

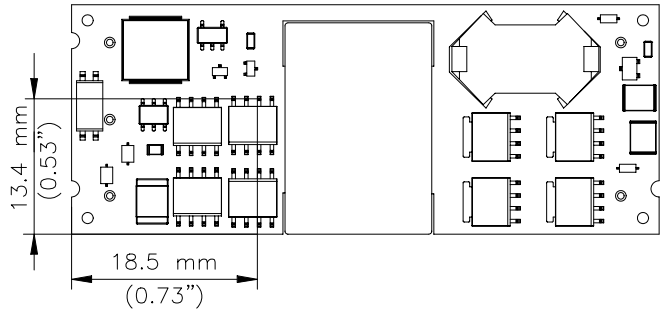


Figure 17: Temperature measurement location  
The allowed maximum hot spot temperature is defined at 117°C

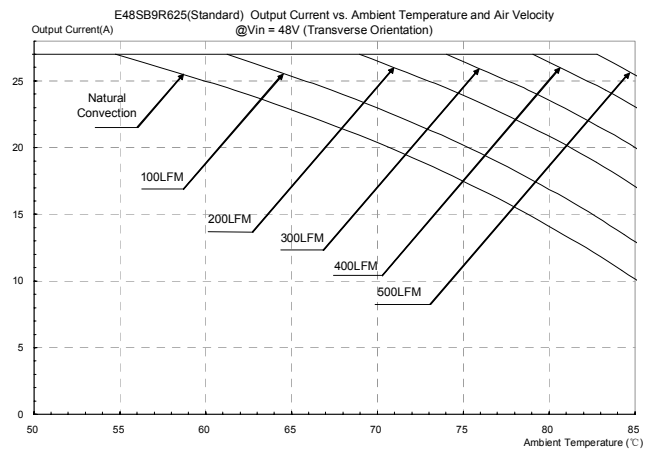
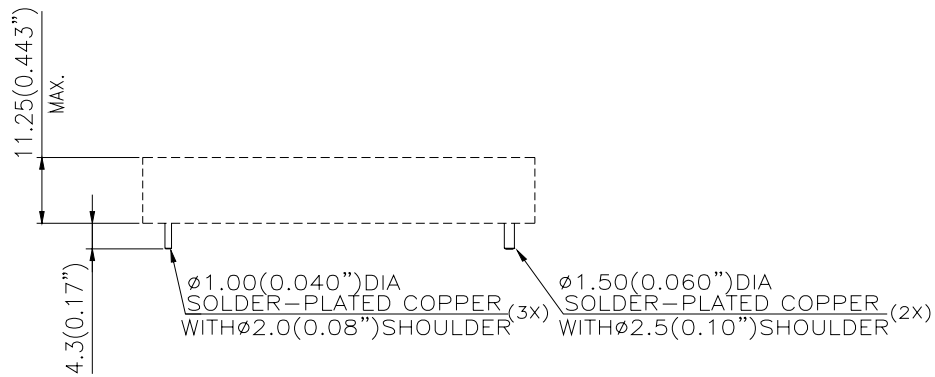
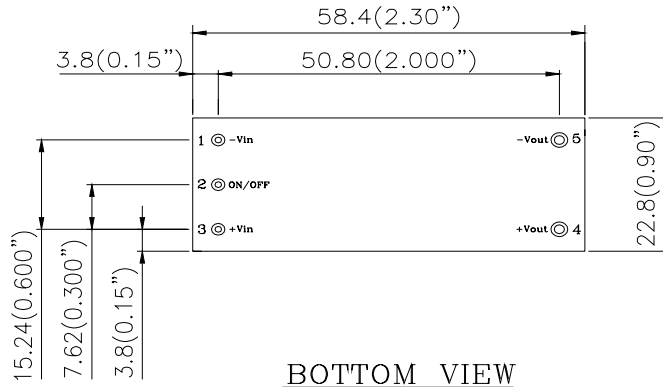


Figure 18: Output current vs. ambient temperature and air velocity @  $V_{in}=48V$  (Transverse Orientation).

# MECHANICAL DRAWING



NOTES:  
 DIMENSIONS ARE IN MILLIMETERS AND (INCHES)  
 TOLERANCES: X.Xmm±0.5mm(X.XX in.±0.02 in.)  
 X.XXmm±0.25mm(X.XXX in.±0.010 in.)

<u>Pin No.</u>	<u>Name</u>	<u>Function</u>
1	-Vin	Negative input voltage
2	ON/OFF	Remote ON/OFF
3	+Vin	Positive input voltage
4	+Vout	Positive output voltage
5	-Vout	Negative output voltage

### Pin Specification:

Pins 1-3 1.0mm (0.040") diameter

Pins 4-5 1.5mm (0.060") diameter

All pins are copper with Tin plating (Pb free)

## PART NUMBERING SYSTEM

E	48	S	B	9R6	25	N	R	F	A
Type of Product	Input Voltage	Number of Outputs	Product Series	Output Voltage	Output Current	ON/OFF Logic	Pin Length		Option Code
E- Eighth Brick	48- 38V~55V	S- Single	B- Bus Converter	9R6- 9.6V	25- 25A	N- Negative P- Positive	R- 0.170" N- 0.145" K- 0.110"	F- RoHS 6/6 (Lead Free)	A- OCP, OTP hiccup B- OCP, OTP latch-up

## MODEL LIST

MODEL NAME	INPUT		OUTPUT			EFF @ 100% LOAD
E48SB9R625NRFA	38V~55V	6.65A	9.6V	25A	240W	96.5%
E48SB12020NRFA	38V~55V	6.5A	12V	20A	240W	96.3%

Note:

1. Default remote on/off logic is negative;
2. Default Pin length is 0.170";
3. Default OTP and output OVP, OCP mode is auto-restart.
4. For different option, please refer to part numbering system above or contact your local sales office.

**CONTACT:** [www.delta.com.tw/dc dc](http://www.delta.com.tw/dc dc)

### USA:

Telephone:  
East Coast: (888) 335 8201  
West Coast: (888) 335 8208  
Fax: (978) 656 3964  
Email: [DCDC@delta-corp.com](mailto:DCDC@delta-corp.com)

### Europe:

Telephone: +41 31 998 53 11  
Fax: +41 31 998 53 53  
Email: [DCDC@delta-es.tw](mailto:DCDC@delta-es.tw)

### Asia & the rest of world:

Telephone: +886 3 4526107 x 6220  
Fax: +886 3 4513485  
Email: [DCDC@delta.com.tw](mailto:DCDC@delta.com.tw)

## WARRANTY

Delta offers a two (2) year limited warranty. Complete warranty information is listed on our web site or is available upon request from Delta.

Information furnished by Delta is believed to be accurate and reliable. However, no responsibility is assumed by Delta for its use, nor for any infringements of patents or other rights of third parties, which may result from its use. No license is granted by implication or otherwise under any patent or patent rights of Delta. Delta reserves the right to revise these specifications at any time, without notice.