

New 48 x 24-mm Basic Temperature Controller with Enhanced Functions and Performance. Improved Indication Accuracy and Preventive Maintenance Function.



E5GN
Models with Screw Terminal
Blocks
48 x 24 mm

E5GN-C
Models with Screwless Clamp
Terminal Blocks
48 x 24 mm



- Indication Accuracy
Thermocouple input: $\pm 0.3\%$ of PV (previous models: $\pm 0.5\%$)
Pt input: $\pm 0.2\%$ of PV (previous models: $\pm 0.5\%$)
Analog input: $\pm 0.2\%$ FS (previous models: $\pm 0.5\%$)
- Models are available with screw terminal blocks or screwless clamp terminal blocks.
- A PV/SV-status display function can be set to automatically alternate between displaying the status of the Temperature Controller (auto/manual, RUN/STOP, and alarms) and the PV or SV.
- Preventive maintenance for relays in the Temperature Controller using a Control Output ON/OFF Counter.
- Switch the PV display between three colors.
- Compatible with Support Software (CX-Thermo version 4.2 or higher).
- Eleven-segment displays.
- Models are available with one or two alarm outputs.

Refer to *Safety Precautions for E5□N/E5□N-H*.

Refer to *Operation for E5□N/E5□N-H* for operating procedures.

Main I/O Functions

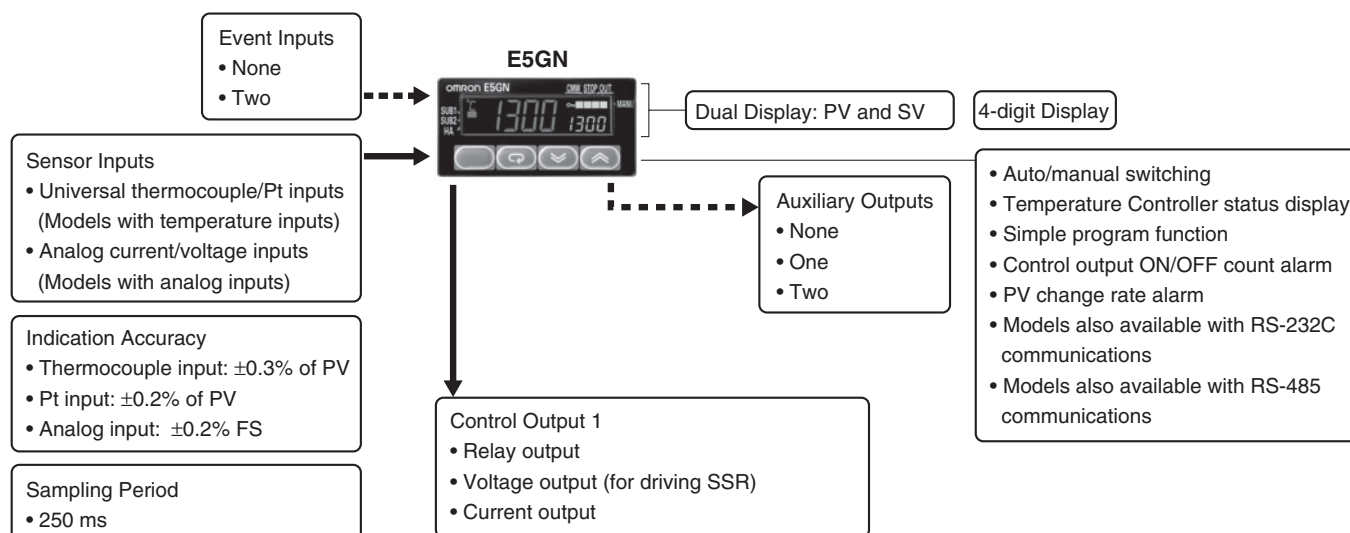

This datasheet is provided as a guideline for selecting products. Be sure to refer to the following user manuals for application precautions and other information required for operation before attempting to use the product.

E5CN/E5AN/E5EN/E5GN Digital Temperature Controllers User's Manual Basic Type (Cat. No. H156)

E5CN/E5AN/E5EN/E5GN Digital Temperature Controllers Communications Manual Basic Type (Cat. No. H158)

Lineup

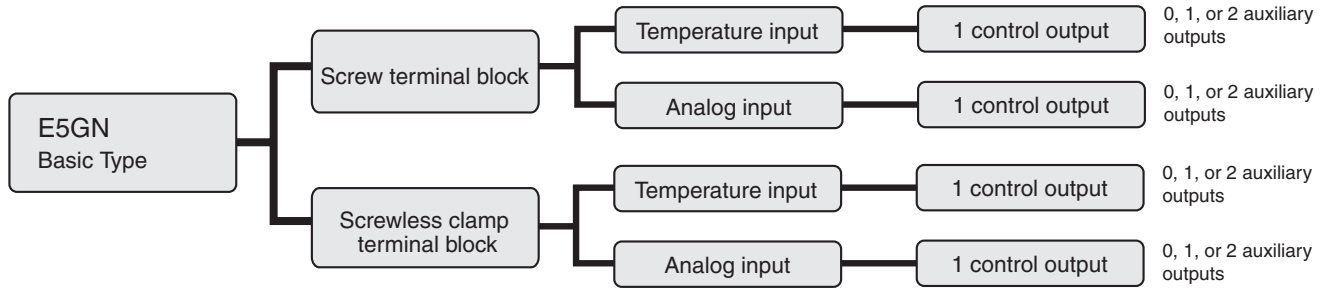

Note: Models with one control output and one or two auxiliary outputs can be used for heating/cooling control.

Model Number Structure

Model Number Legend

Controllers

E5GN-□□□□□-□-□-□
 1 2 3 4 5 6 7 8

1. Control Output 1

R: Relay output
 Q: Voltage output (for driving SSR)
 C: Linear current output

2. Auxiliary Outputs

Blank: None
 1: One output
 2: Two outputs

3. Option

Blank: None
 01: RS-232C communications
 03: RS-485 communications
 B: Two event inputs
 H: Heater burnout/Heater short/Heater overcurrent detection (CT1)

Note: Models cannot be made for all combinations of options that are possible in the model number legend. Confirm model availability in *Ordering Information* before ordering.

* Auxiliary outputs are relay outputs that can be used to output alarms or processing results.

4. Input Type

T: Universal thermocouple/platinum resistance thermometer input
 L: Analog current/voltage input

5. Power Supply Voltage

Blank: 100 to 240 VAC
 D: 24 VAC/VDC

6. Terminal Type

Blank: Models with screw terminal block
 C: Models with screwless clamp terminal block

7. Case Color

Blank: Black

8. Communications Protocol

Blank: None
 FLK: CompoWay/F communications

Ordering Information

Controllers with Screw Terminal Blocks

Models with Temperature Inputs

Models with One Control Output and a 100 to 240-VAC Power Supply

Case color	Control output	Control mode *1	No. of auxiliary outputs	Detection of heater burnout, SSR failure, and heater overcurrent	No. of event inputs	Transfer output *2	Communi-cations	Previous model		New model			
								Thermocouple input	Resistance thermometer input				
Black	Relay output	Standard	---	---	---	---	---	E5GN-RTC	E5GN-RP	E5GN-RT			
		Standard or heating/cooling	1		---			2	---	---	E5GN-R1TC	E5GN-R1P	E5GN-R1T
					---			---	---	---	---	---	E5GN-R1BT
					---			---	RS-232C	---	---	---	E5GN-R101T-FLK
					---			---	RS-485	E5GN-R03TC-FLK	E5GN-R03P-FLK	---	E5GN-R103T-FLK
					---			---	---	---	---	---	E5GN-R2T
					---			---	---	---	---	---	E5GN-R2HT
			2		---			2	---	---	---	E5GN-R2BT	
					---			---	---	---	---	---	E5GN-R203T-FLK
					---			---	---	---	---	---	---
					---			---	---	---	---	---	---
		Voltage output (for driving SSR)	Standard		---			---	---	---	---	---	E5GN-QTC
	Standard or heating/cooling		1	---	2	---	---		E5GN-Q1TC	E5GN-Q1P			E5GN-Q1T
				---	---	---	---		---	---			E5GN-Q1BT
				---	---	RS-232C	---		---	---			E5GN-Q101T-FLK
				---	---	RS-485	E5GN-Q03TC-FLK		E5GN-Q03P-FLK	---			E5GN-Q103T-FLK
				---	---	---	---		---	---			E5GN-Q2T
				---	---	---	---		---	---			E5GN-Q2HT
			2	---	2	---	---		---	E5GN-Q2BT			
				---	---	---	---		---	---			---
				---	---	---	---		---	---			---
				---	---	---	---		---	---			---
	Current output		Standard or heating/cooling	1	---	---	---		Transfer output using control output	---			---
		2				---	---	---			E5GN-C1BT		
---		---				---	---	---			---	---	
---		---				RS-232C	---	---			---	E5GN-C101T-FLK	
---		---				RS-485	---	---			---	E5GN-C103T-FLK	
---		---				---	---	---			---	---	

*1. If heating/cooling control mode is used, an auxiliary output is used as a control output for the cooling side. The number of auxiliary outputs that can be used will decrease by one. Also, the signal for the control output for the cooling side will be a relay output.

*2. A current control output can be used as the transfer output. In that case, an auxiliary output is used as the control output. (This is not possible for models without an auxiliary output.) The control output will be a relay output. The number of auxiliary outputs that can be used will decrease by one.

Models with One Control Output and a 24-VAC/VDC Power Supply

Case color	Control output	Control mode *1	No. of auxiliary outputs	Detection of heater burnout, SSR failure, and heater overcurrent	No. of event inputs	Transfer output *2	Communi-cations	Previous model		New model			
								Thermocou-ple input	Resistance thermome-ter input				
Black	Relay output	Standard	---	---	---	---	---	E5GN-RTC	E5GN-RP	E5GN-RTD			
		Standard or heating/cooling	1		---			---	E5GN-R1TC	E5GN-R1P	E5GN-R1TD		
					---			---	---	---	E5GN-R1BTD		
					---			---	---	---	E5GN-R101TD-FLK		
			2		Detection for single-phase heaters			---	---	---	---	E5GN-R103TD-FLK	
								---	---	---	---	E5GN-R2TD	
								---	---	---	---	E5GN-R2HTD	
					---			---	---	---	---	---	E5GN-R2BTD
								---	---	---	---	---	E5GN-R203TD-FLK
								---	---	---	---	---	---
	Voltage output (for driving SSR)	Standard	---	---	---	---	---	E5GN-QTC	E5GN-QP	E5GN-QTD			
		Standard or heating/cooling	1		---			---	E5GN-Q1TC	E5GN-Q1P	E5GN-Q1TD		
					---			---	---	---	E5GN-Q1BTD		
					---			---	---	---	E5GN-Q101TD-FLK		
			2		Detection for single-phase heaters			---	---	---	---	E5GN-Q103TD-FLK	
								---	---	---	---	E5GN-Q2TD	
								---	---	---	---	E5GN-Q2HTD	
					---			---	---	---	---	---	E5GN-Q2BTD
								---	---	---	---	---	E5GN-Q203TD-FLK
								---	---	---	---	---	---
								---	---	---	---	---	---
Current output	Standard or heating/cooling	1	---	---	---	Transfer output using control output	---	---	---	E5GN-C1TD			
				---			---	---	---	E5GN-C1BTD			
				---			---	---	---	---			
				---			---	---	---	---	E5GN-C101TD-FLK		
				---			---	---	---	---	E5GN-C103TD-FLK		

*1. If heating/cooling control mode is used, an auxiliary output is used as a control output for the cooling side. The number of auxiliary outputs that can be used will decrease by one. Also, the signal for the control output for the cooling side will be a relay output.

*2. A current control output can be used as the transfer output. In that case, an auxiliary output is used as the control output. (This is not possible for models without an auxiliary output.) The control output will be a relay output. The number of auxiliary outputs that can be used will decrease by one.

Models with Analog Inputs

Models with One Control Output and a 100 to 240-VAC Power Supply

Case color	Control output	Control mode *1	No. of auxiliary outputs	Detection of heater burnout, SSR failure, and heater overcurrent	No. of event inputs	Transfer output *2	Communi-cations	Previous model		New model
								Thermocou-ple input	Resistance thermome-ter input	
Black	Relay output	Standard or heating/cooling	1	---	---	---	RS-485	---	---	E5GN-R103L-FLK
	Voltage output (for driving SSR)							---	---	E5GN-Q103L-FLK
	Current output					Transfer output using control output	---	---	E5GN-C1L	

Note: Models with analog inputs do not display the temperature unit.

*1. If heating/cooling control mode is used, an auxiliary output is used as a control output for the cooling side. The number of auxiliary outputs that can be used will decrease by one. Also, the signal for the control output for the cooling side will be a relay output.

*2. A current control output can be used as the transfer output. In that case, an auxiliary output is used as the control output. (This is not possible for models without an auxiliary output.) The control output will be a relay output. The number of auxiliary outputs that can be used will decrease by one.

Models with One Control Output and a 24-VAC/VDC Power Supply

Case color	Control output	Control mode *1	No. of auxiliary outputs	Detection of heater burnout, SSR failure, and heater overcurrent	No. of event inputs	Transfer output *2	Communi-cations	Previous model		New model
								Thermocou-ple input	Resistance thermome-ter input	
Black	Relay output	Standard or heating/cooling	1	---	---	---	RS-485	---	---	E5GN-R103LD-FLK
	Voltage output (for driving SSR)							---	---	E5GN-Q103LD-FLK
	Current output					Transfer output using control output	---	---	E5GN-C1LD	

*1. If heating/cooling control mode is used, an auxiliary output is used as a control output for the cooling side. The number of auxiliary outputs that can be used will decrease by one. Also, the signal for the control output for the cooling side will be a relay output.

*2. A current control output can be used as the transfer output. In that case, an auxiliary output is used as the control output. (This is not possible for models without an auxiliary output.) The control output will be a relay output. The number of auxiliary outputs that can be used will decrease by one.

Controllers with Screwless Clamp Terminal Blocks

Models with Temperature Inputs

Models with One Control Output and a 100 to 240-VAC Power Supply

Case color	Control output	Control mode *1	No. of auxiliary outputs	Detection of heater burnout, SSR failure, and heater overcurrent	No. of event inputs	Transfer output *2	Communications	Previous model		New model					
								Thermocouple input	Resistance thermometer input						
Black	Relay output	Standard	---	---	---	---	---	E5GN-RTC	E5GN-RP	E5GN-RT-C					
		Standard or heating/cooling	1		---			---	E5GN-R1TC	E5GN-R1P	E5GN-R1T-C				
					---			---	---	---	E5GN-R1BT-C				
		Standard or heating/cooling	2		Detection for single-phase heaters			---	---	RS-232C	---	---	E5GN-R101T-C-FLK		
								---	---	RS-485	E5GN-R03TC-FLK	E5GN-R03P-FLK	E5GN-R103T-C-FLK		
		Standard or heating/cooling	2		---			---	---	---	---	---	E5GN-R2T-C		
								---	---	---	---	E5GN-R2HT-C			
		Standard or heating/cooling	2		---			2	---	---	---	---	E5GN-R2BT-C		
								---	---	RS-485	---	---	E5GN-R203T-C-FLK		
		Voltage output (for driving SSR)	Standard		---			---	---	---	---	---	E5GN-QTC	E5GN-QP	E5GN-QT-C
			Standard or heating/cooling		1				---	---			E5GN-Q1TC	E5GN-Q1P	E5GN-Q1T-C
									---	---			---	---	E5GN-Q1BT-C
	Standard or heating/cooling		2	Detection for single-phase heaters	---	---	RS-232C		---	---			E5GN-Q101T-C-FLK		
					---	---	RS-485		E5GN-Q03TC-FLK	E5GN-Q03P-FLK			E5GN-Q103T-C-FLK		
	Standard or heating/cooling		2	---	---	---	---		---	---			E5GN-Q2T-C		
					---	---	---		---	E5GN-Q2HT-C					
	Standard or heating/cooling		2	---	2	---	---		---	---			E5GN-Q2BT-C		
					---	---	RS-485		---	---			E5GN-Q203T-C-FLK		
	Current output		Standard or heating/cooling	1	---	---	---		Transfer output using control output	---			---	---	E5GN-C1T-C
						2	---						---	---	E5GN-C1BT-C
						---	---						RS-232C	---	---
		---				---	RS-485	---			---	E5GN-C103T-C-FLK			
		---				---	---	---			---	---			
		---				---	---	---			---	---			

*1. If heating/cooling control mode is used, an auxiliary output is used as a control output for the cooling side. The number of auxiliary outputs that can be used will decrease by one. Also, the signal for the control output for the cooling side will be a relay output.

*2. A current control output can be used as the transfer output. In that case, an auxiliary output is used as the control output. (This is not possible for models without an auxiliary output.) The control output will be a relay output. The number of auxiliary outputs that can be used will decrease by one.

Models with One Control Output and a 24-VAC/VDC Power Supply

Case color	Control output	Control mode *1	No. of auxiliary outputs	Detection of heater burnout, SSR failure, and heater overcurrent	No. of event inputs	Transfer output *2	Communications	Previous model		New model			
								Thermocouple input	Resistance thermometer input				
Black	Relay output	Standard	---	---	---	---	---	E5GN-RTC	E5GN-RP	E5GN-RTD-C			
					2			E5GN-R1TC	E5GN-R1P	E5GN-R1TD-C			
					---			---	E5GN-R1BTD-C				
		Standard or heating/cooling	1	---	---	---	---	---	RS-232C	---	---	E5GN-R101TD-C-FLK	
									RS-485	E5GN-R03TC-FLK	E5GN-R03P-FLK	E5GN-R103TD-C-FLK	
									---	---	---	E5GN-R2TD-C	
			2	---	---	Detection for single-phase heaters	---	---	---	---	---	---	E5GN-R2HTD-C
										2	---	---	E5GN-R2BTD-C
										---	---	---	E5GN-R203TD-C-FLK
			Voltage output (for driving SSR)	Standard	---	---	---	---	---	---	E5GN-QTC	E5GN-QP	E5GN-QTD-C
								2			E5GN-Q1TC	E5GN-Q1P	E5GN-Q1TD-C
								---			---	---	E5GN-Q1BTD-C
	Standard or heating/cooling	1		---	---	---	---	---	RS-232C	---	---	E5GN-Q101TD-C-FLK	
									RS-485	E5GN-Q03TC-FLK	E5GN-Q03P-FLK	E5GN-Q103TD-C-FLK	
									---	---	---	E5GN-Q2TD-C	
		2		---	---	Detection for single-phase heaters	---	---	---	---	---	---	E5GN-Q2HTD-C
										2	---	---	E5GN-Q2BTD-C
										---	---	---	E5GN-Q203TD-C-FLK
	Current output	Standard or heating/cooling	1	---	---	---	Transfer output using control output	---	---	---	E5GN-C1TD-C		
						2			---	---	E5GN-C1BTD-C		
						---			---	---	E5GN-C101TD-C-FLK		
						---			---	---	E5GN-C103TD-C-FLK		
						RS-232C			---	---	E5GN-C101TD-C-FLK		
						RS-485			---	---	E5GN-C103TD-C-FLK		

*1. If heating/cooling control mode is used, an auxiliary output is used as a control output for the cooling side. The number of auxiliary outputs that can be used will decrease by one. Also, the signal for the control output for the cooling side will be a relay output.

*2. A current control output can be used as the transfer output. In that case, an auxiliary output is used as the control output. (This is not possible for models without an auxiliary output.) The control output will be a relay output. The number of auxiliary outputs that can be used will decrease by one.

Models with Analog Inputs

Models with One Control Output and a 100 to 240-VAC Power Supply

Case color	Control output	Control mode *1	No. of auxiliary outputs	Detection of heater burnout, SSR failure, and heater overcurrent	No. of event inputs	Transfer output *2	Communications	Previous model		New model
								Thermocouple input	Resistance thermometer input	
Black	Current output	Standard or heating/cooling	1	---	---	Transfer output using control output	---	---	---	E5GN-C1L-C

Note: Models with analog inputs do not display the temperature unit.

*1. If heating/cooling control mode is used, an auxiliary output is used as a control output for the cooling side. The number of auxiliary outputs that can be used will decrease by one. Also, the signal for the control output for the cooling side will be a relay output.

*2. A current control output can be used as the transfer output. In that case, an auxiliary output is used as the control output. (This is not possible for models without an auxiliary output.) The control output will be a relay output. The number of auxiliary outputs that can be used will decrease by one.

Models with One Control Output and a 24-VAC/VDC Power Supply

Case color	Control output	Control mode *1	No. of auxiliary outputs	Detection of heater burnout, SSR failure, and heater overcurrent	No. of event inputs	Transfer output *2	Communications	Previous model		New model
								Thermocouple input	Resistance thermometer input	
Black	Current output	Standard or heating/cooling	1	---	---	Transfer output using control output	---	---	---	E5GN-C1LD-C

*1. If heating/cooling control mode is used, an auxiliary output is used as a control output for the cooling side. The number of auxiliary outputs that can be used will decrease by one. Also, the signal for the control output for the cooling side will be a relay output.

*2. A current control output can be used as the transfer output. In that case, an auxiliary output is used as the control output. (This is not possible for models without an auxiliary output.) The control output will be a relay output. The number of auxiliary outputs that can be used will decrease by one.

Accessories (Order Separately)

USB-Serial Conversion Cable

Model
E58-CIFQ1

Waterproof Packing

Model
Y92S-32

Current Transformers (CTs)

Hole diameter	Model
5.8 dia.	E54-CT1
12.0 dia.	E54-CT3

CX-Thermo Support Software

Model
EST2-2C-MV4

Note: The E5GN is supported by CX-Thermo version 4.2 and higher.

Specifications

Ratings



Power supply voltage		No D in model number: 100 to 240 VAC, 50/60 Hz D in model number: 24 VAC, 50/60 Hz; 24 VDC
Operating voltage range		85% to 110% of rated supply voltage
Power consumption	E5GN Screw terminal block	100 to 240 VAC: 5.5 VA (max.) 24 VAC/VDC: 3 VA/2 W (max.)
	E5GN-□-C Screwless clamp terminal block	100 to 240 VAC: 5.5 VA (max.) 24 VAC/VDC: 3 VA/2 W (max.)
Sensor input		Models with temperature inputs Thermocouple: K, J, T, E, L, U, N, R, S, B, W, or PL II Platinum resistance thermometer: Pt100 or JPt100 Infrared temperature sensor: 10 to 70°C, 60 to 120°C, 115 to 165°C, or 140 to 260°C Voltage input: 0 to 50 mV
		Models with analog inputs Current input: 4 to 20 mA or 0 to 20 mA Voltage input: 1 to 5 V, 0 to 5 V, or 0 to 10 V
Input impedance		Current input: 150 Ω max., Voltage input: 1 MΩ min. (Use a 1:1 connection when connecting the ES2-HB.)
Control method		ON/OFF control or 2-PID control (with auto-tuning)
Control outputs	Relay output	SPST-NO, 250 VAC, 2 A (resistive load), electrical life: 100,000 operations, minimum applicable load: 5 V, 10 mA
	Voltage output (for driving SSR)	Output voltage: 12 VDC ±15% (PNP), max. load current: 21 mA, with short-circuit protection circuit
	Current output	4 to 20 mA DC/0 to 20 mA DC, load: 500 Ω max., resolution: approx. 10,000
Auxiliary outputs	Number of outputs	1 or 2 max. (Depends on the model.)
	Output specifications	Relay output: SPST-NO, 250 VAC, 2 A (resistive load), electrical life: 100,000 operations, minimum applicable load: 5 V, 10 mA
Event inputs	Number of inputs	2
	External contact input specifications	Contact input: ON: 1 kΩ max., OFF: 100 kΩ min.
		Non-contact input: ON: Residual voltage: 1.5 V max., OFF: Leakage current: 0.1 mA max. Current flow: Approx. 7 mA per contact
Setting method		Digital setting using front panel keys
Indication method		11-segment digital display and individual indicators (7-segment display also possible) Character height: PV: 7.5 mm, SV: 3.6 mm
Multi SP		Up to four set points (SP0 to SP3) can be saved and selected using event inputs, key operations, or serial communications.
Bank switching		Not supported
Other functions		Manual output, heating/cooling control, loop burnout alarm, SP ramp, other alarm functions, heater burnout detection, 40% AT, 100% AT, MV limiter, input digital filter, self-tuning, temperature input shift, run/stop, protection functions, control output ON/OFF counter, extraction of square root, MV change rate limit, logic operations, PV/SV status display, simple program, automatic cooling coefficient adjustment
Ambient operating temperature		-10 to 55°C (with no condensation or icing), for 3-year warranty: -10 to 50°C
Ambient operating humidity		25% to 85%
Storage temperature		-25 to 65°C (with no condensation or icing)

Alarm Outputs

Each alarm can be independently set to one of the following 13 alarm types. The default is 2: *Upper limit*.

Auxiliary outputs are allocated for alarms. ON delays and OFF delays (0 to 999 s) can also be specified.

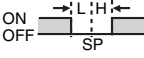
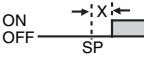
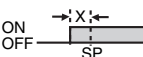
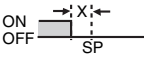
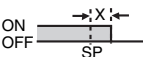
Note: For models with heater burnout, SSR failure, and heater overcurrent detection, alarm 1 will be an OR output of the alarm selected from the following alarm types and the alarms for heater burnout, SSR failure, and heater overcurrent. To output only a heater burnout alarm, SSR failure alarm, and heater overcurrent alarm for alarm 1, set the alarm type to 0 (i.e., no alarm function).

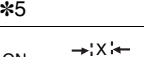
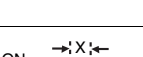
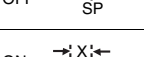
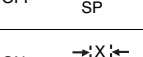
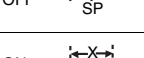
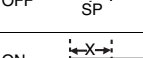
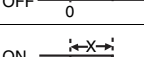
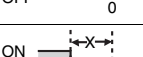
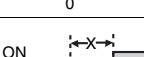
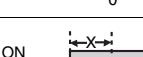
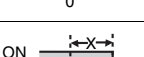
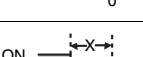
Set value	Alarm type	Alarm output operation		Description of function
		When alarm value X is positive	When alarm value X is negative	
0	Alarm function OFF	Output OFF		No alarm
1 *1	Upper- and lower-limit	ON OFF 	*2	Set the deviation in the set point by setting the alarm upper limit (H) and alarm lower limit (L).
2	Upper-limit	ON OFF 	ON OFF 	Set the upward deviation in the set point by setting the alarm value (X).
3	Lower-limit	ON OFF 	ON OFF 	Set the downward deviation in the set point by setting the alarm value (X).
4 *1	Upper- and lower-limit range	ON OFF 	*3	Set the deviation in the set point by setting the alarm upper limit (H) and alarm lower limit (L).
5 *1	Upper- and lower-limit with standby sequence	ON OFF 	*4	A standby sequence is added to the upper- and lower-limit alarm (1). *6
6	Upper-limit with standby sequence	ON OFF 	ON OFF 	A standby sequence is added to the upper-limit alarm (2). *6
7	Lower-limit with standby sequence	ON OFF 	ON OFF 	A standby sequence is added to the lower-limit alarm (3). *6
8	Absolute-value upper-limit	ON OFF 	ON OFF 	The alarm will turn ON if the process value is larger than the alarm value (X) regardless of the set point.
9	Absolute-value lower-limit	ON OFF 	ON OFF 	The alarm will turn ON if the process value is smaller than the alarm value (X) regardless of the set point.
10	Absolute-value upper-limit with standby sequence	ON OFF 	ON OFF 	A standby sequence is added to the absolute-value upper-limit alarm (8). *6
11	Absolute-value lower-limit with standby sequence	ON OFF 	ON OFF 	A standby sequence is added to the absolute-value lower-limit alarm (9). *6
12	LBA (alarm 1 type only)	---		*7
13	PV change rate alarm	---		*8

*1. With set values 1, 4 and 5, the upper and lower limit values can be set independently for each alarm type, and are expressed as "L" and "H."

*2. Set value: 1, Upper- and lower-limit alarm

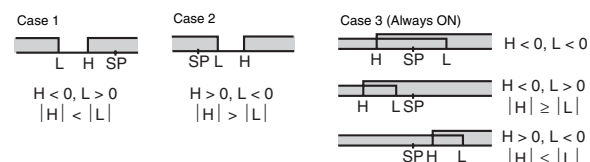

*3. Set value: 4, Upper- and lower-limit range

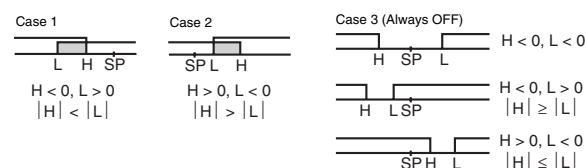

*4. Set value: 5, Upper- and lower-limit with standby sequence
For Upper- and Lower-Limit Alarm Described Above

• Case 1 and 2

Always OFF when the upper-limit and lower-limit hysteresis overlaps.

• Case 3: Always OFF

*5. Set value: 5, Upper- and lower-limit with standby sequence
Always OFF when the upper-limit and lower-limit hysteresis overlaps.

*6. Refer to the *E5CN/E5AN/E5EN/E5GN Digital Temperature Controllers User's Manual Basic Type* (Cat. No. H156) for information on the operation of the standby sequence.

*7. Refer to the *E5CN/E5AN/E5EN/E5GN Digital Temperature Controllers User's Manual Basic Type* (Cat. No. H156) for information on the loop burnout alarm (LBA).

*8. Refer to the *E5CN/E5AN/E5EN/E5GN Digital Temperature Controllers User's Manual Basic Type* (Cat. No. H156) for information on the PV change rate alarm.

Characteristics

Indication accuracy	Thermocouple: *1 ($\pm 0.3\%$ of indicated value or $\pm 1^\circ\text{C}$, whichever is greater) ± 1 digit max. Platinum resistance thermometer input: ($\pm 0.2\%$ of indicated value or $\pm 0.8^\circ\text{C}$, whichever is greater) ± 1 digit max. Analog input: $\pm 0.2\%$ FS ± 1 digit max. CT input: $\pm 5\%$ FS ± 1 digit max.	
Influence of temperature *2	Thermocouple input (R, S, B, W, PL II): ($\pm 1\%$ of PV or $\pm 10^\circ\text{C}$, whichever is greater) ± 1 digit max. Other thermocouple input: *3 ($\pm 1\%$ of PV or $\pm 4^\circ\text{C}$, whichever is greater) ± 1 digit max.	
Influence of voltage *2	Platinum resistance thermometer input: ($\pm 1\%$ of PV or $\pm 2^\circ\text{C}$, whichever is greater) ± 1 digit max. Analog input: ($\pm 1\%$ FS) ± 1 digit max.	
Input sampling period	250 ms	
Hysteresis	Models with thermocouple/platinum resistance thermometer input (universal input): 0.1 to 999.9 EU (in units of 0.1 EU) *4 Models with analog input: 0.01 to 99.99% FS (in units of 0.01% FS)	
Proportional band (P)	Models with thermocouple/platinum resistance thermometer input (universal input): 0.1 to 999.9 EU (in units of 0.1 EU) *4 Models with analog input: 0.1 to 999.9% FS (in units of 0.1% FS)	
Integral time (I)	0 to 3999 s (in units of 1 s)	
Derivative time (D)	0 to 3999 s (in units of 1 s) *5	
Control period	0.5, 1 to 99 s (in units of 1 s)	
Manual reset value	0.0 to 100.0% (in units of 0.1%)	
Alarm setting range	-1999 to 9999 (decimal point position depends on input type)	
Affect of signal source resistance	Thermocouple: $0.1^\circ\text{C}/\Omega$ max. (100 Ω max.) Platinum resistance thermometer: $0.1^\circ\text{C}/\Omega$ max. (10 Ω max.)	
Insulation resistance	20 M Ω min. (at 500 VDC)	
Dielectric strength	2,300 VAC, 50 or 60 Hz for 1 min (between terminals with different charge)	
Vibration resistance	Malfunction	10 to 55 Hz, 20 m/s ² for 10 min each in X, Y, and Z directions
	Destruction	10 to 55 Hz, 0.75-mm single amplitude for 2 hrs each in X, Y, and Z directions
Shock resistance	Malfunction	100 m/s ² , 3 times each in X, Y, and Z directions
	Destruction	300 m/s ² , 3 times each in X, Y, and Z directions
Weight	Controller: Approx. 90 g, Mounting Bracket: Approx. 10 g	
Degree of protection	Front panel: IP66, Rear case: IP20, Terminals: IP00	
Memory protection	Non-volatile memory (number of writes: 1,000,000 times)	
Setup Tool	CX-Thermo version 4.2 or higher	
Setup Tool port	Provided on the side of the E5GN. Connect this port to the computer when using the Setup Tool. An E58-CIFQ1 USB-Serial Conversion Cable is required to connect the computer to the port on the side of the E5GN. *6	
Standards	Approved standards	UL 61010-1, CSA C22.2 No. 1010-1
	Conformed standards	EN 61010-1 (IEC 61010-1): Pollution level 2, overcurrent category II
EMC	EMI: Radiated Interference Electromagnetic Field Strength: EN 55011 Group 1, class A Noise Terminal Voltage: EN 55011 Group 1, class A EMS: ESD Immunity: EN 61000-4-2 Electromagnetic Field Immunity: EN 61000-4-3 Burst Noise Immunity: EN 61000-4-4 Conducted Disturbance Immunity: EN 61000-4-6 Surge Immunity: EN 61000-4-5 Power Frequency Magnetic Field Immunity: EN 61000-4-8 Voltage Dip/Interrupting Immunity: EN 61000-4-11	

*1. The indication accuracy of K thermocouples in the -200 to 1300°C range, T and N thermocouples at a temperature of -100°C max., and U and L thermocouples at any temperatures is $\pm 2^\circ\text{C} \pm 1$ digit max. The indication accuracy of the B thermocouple at a temperature of 400°C max. is not specified. The indication accuracy of B thermocouples in the 400 to 800°C range is $\pm 3^\circ\text{C}$ max. The indication accuracy of the R and S thermocouples at a temperature of 200°C max. is $\pm 3^\circ\text{C} \pm 1$ digit max. The indication accuracy of W thermocouples is ± 0.3 of PV or $\pm 3^\circ\text{C}$, whichever is greater, ± 1 digit max. The indication accuracy of PL II thermocouples is ± 0.3 of PV or $\pm 2^\circ\text{C}$, whichever is greater, ± 1 digit max.

*2. Ambient temperature: -10°C to 23°C to 55°C, Voltage range: -15% to 10% of rated voltage

*3. K thermocouple at -100°C max.: $\pm 10^\circ$ max.

*4. "EU" stands for Engineering Unit and is used as the unit after scaling. For a temperature sensor, the EU is °C or °F.

*5. When robust tuning (RT) is ON, the differential time is 0.0 to 999.9 (in units of 0.1 s).

*6. External serial communications (RS-232C or RS-485) and cable communications for the Setup Tool can be used at the same time.

USB-Serial Conversion Cable

Applicable OS	Windows 2000, XP, or Vista
Applicable software	CX-Thermo version 4 or higher
Applicable models	E5AN/E5EN/E5CN/E5CN-U/E5AN-H/ E5EN-H/E5CN-H/E5GN
USB interface standard	Conforms to USB Specification 1.1.
DTE speed	38400 bps
Connector specifications	Computer: USB (type A plug) Temperature Controller: Setup Tool port (on bottom of Controller)
Power supply	Bus power (Supplied from USB host controller.)
Power supply voltage	5 VDC
Current consumption	70 mA
Ambient operating temperature	0 to 55°C (with no condensation or icing)
Ambient operating humidity	10% to 80%
Storage temperature	-20 to 60°C (with no condensation or icing)
Storage humidity	10% to 80%
Altitude	2,000 m max.
Weight	Approx. 100 g

Note: A driver must be installed in the personal computer. Refer to installation information in the operation manual for the Conversion Cable.

Communications Specifications

Transmission line connection method	RS-485: Multipoint RS-232C: Point-to-point
Communications	RS-485 (two-wire, half duplex), RS-232C
Synchronization method	Start-stop synchronization
Protocol	CompoWay/F, SYSWAY, or Modbus
Baud rate	1200, 2400, 4800, 9600, 19200, 38400, or 57600 bps
Transmission code	ASCII
Data bit length *	7 or 8 bits
Stop bit length *	1 or 2 bits
Error detection	Vertical parity (none, even, odd) Frame check sequence (FCS) with SYSWAY Block check character (BCC) with CompoWay/F or CRC-16 Modbus
Flow control	None
Interface	RS-485, RS-232C
Retry function	None
Communications buffer	217 bytes
Communications response wait time	0 to 99 ms Default: 20 ms

* The baud rate, data bit length, stop bit length, and vertical parity can be individually set using the Communications Setting Level.

Current Transformer (Order Separately) Ratings

Dielectric strength	1,000 VAC for 1 min
Vibration resistance	50 Hz, 98 m/s ²
Weight	E54-CT1: Approx. 11.5 g, E54-CT3: Approx. 50 g
Accessories (E54-CT3 only)	Armatures (2) Plugs (2)

Heater Burnout Alarms, SSR Failure Alarms, and Heater Overcurrent Alarms

CT input (for heater current detection)	Models with detection for single-phase heaters: One input
Maximum heater current	50 A AC
Input current indication accuracy	±5% FS ±1 digit max.
Heater burnout alarm setting range *1	0.1 to 49.9 A (in units of 0.1 A) Minimum detection ON time: 100 ms
SSR failure alarm setting range *2	0.1 to 49.9 A (in units of 0.1 A) Minimum detection OFF time: 100 ms
Heater overcurrent alarm setting range *3	0.1 to 49.9 A (in units of 0.1 A) Minimum detection ON time: 100 ms

- *1. For heater burnout alarms, the heater current will be measured when the control output is ON, and the output assigned to the alarm 1 function will turn ON if the heater current is lower than the set value (i.e., heater burnout detection current value).
- *2. For SSR failure alarms, the heater current will be measured when the control output is OFF, and the output assigned to the alarm 1 function will turn ON if the heater current is higher than the set value (i.e., SSR failure detection current value).
- *3. For heater overcurrent alarms, the heater current will be measured when the control output is ON, and the output assigned to the alarm 1 function will turn ON if the heater current is higher than the set value (i.e., heater overcurrent detection current value).

Electrical Life Expectancy Curve for Relays (Reference Values)

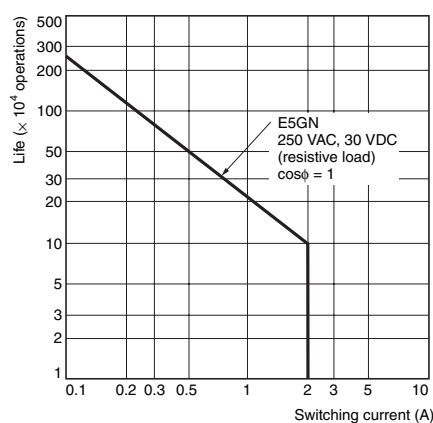

External Connections

- A voltage output (control output, for driving SSR) is not electrically insulated from the internal circuits. When using a grounding thermocouple, do not connect any of the control output terminals to

ground. (If the control output terminals are connected to ground, errors will occur in the measured temperature values as a result of leakage current.)

E5GN

Controllers

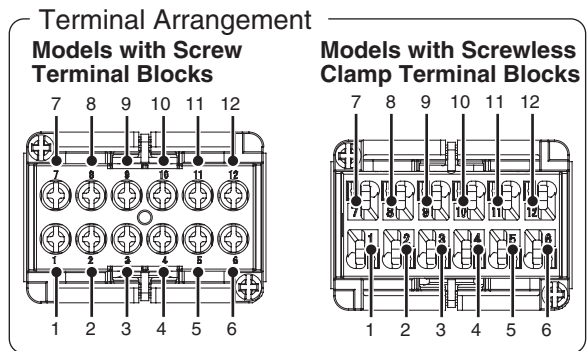
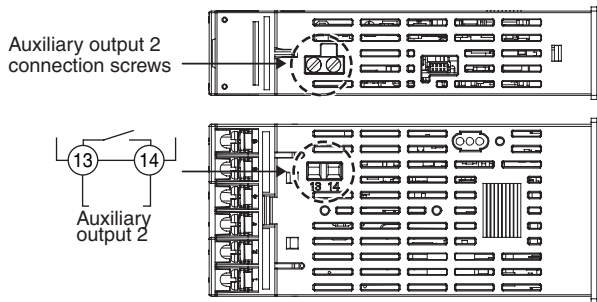
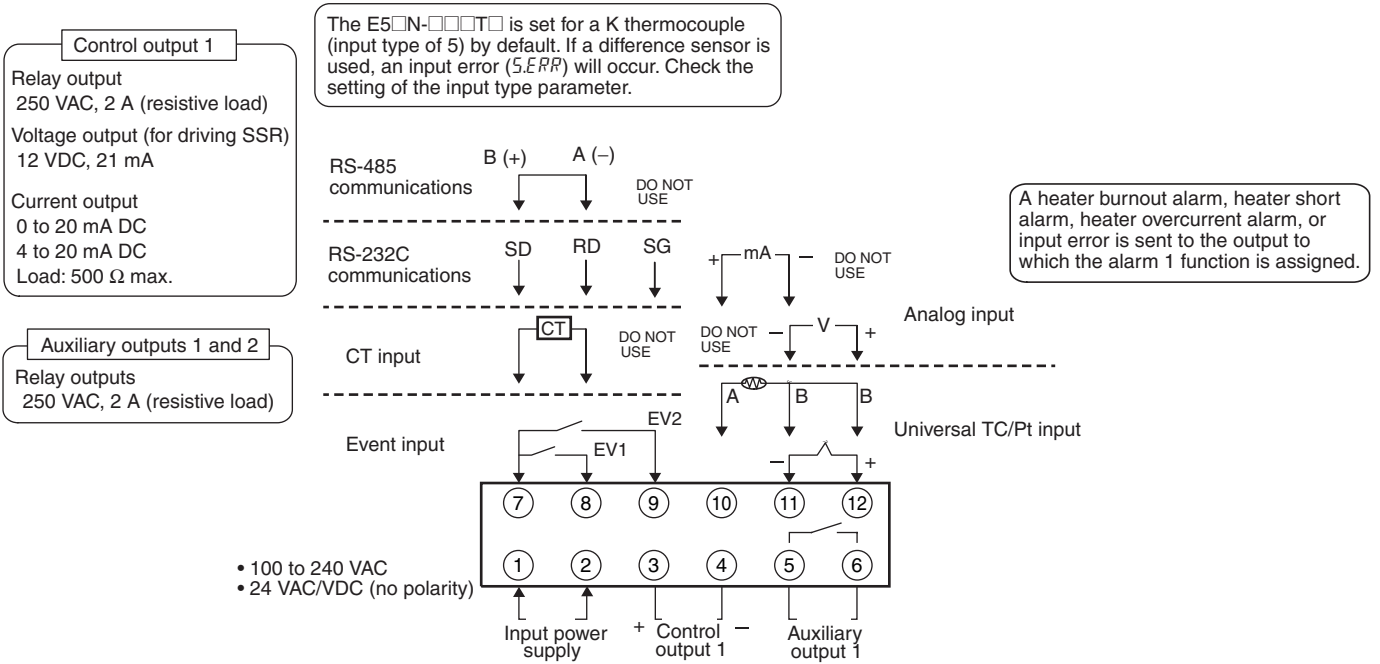

Wiring

E5GN

Models with Screw Terminal Blocks (M3 Screws)

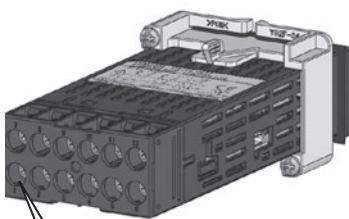

M3 Screw Terminal Blocks

- Crimp terminal shape: Forked or round
- Tightening torque for all terminals: 0.5 N·m

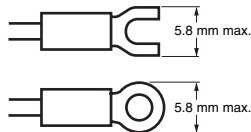

E5GN-□-C

Models with Screwless Clamp Terminal Blocks

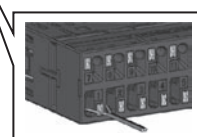
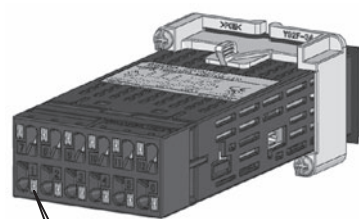

Models with Screwless Clamp Terminal Blocks

- Wire stripping: 10 mm
- Ferrules: 8 to 12 mm

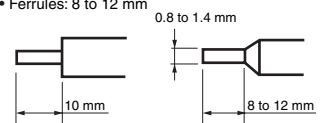

Nomenclature

E5GN

The front panel is the same for the E5GN.

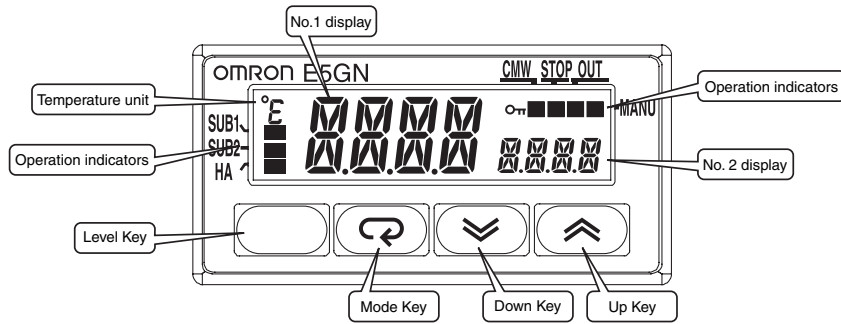

Dimensions

(Unit: mm)

E5GN Models with Screw Terminal Blocks

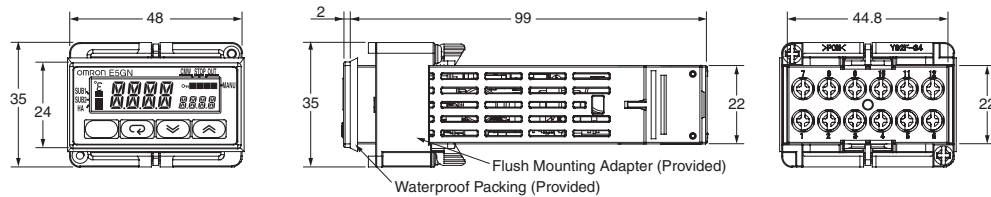

Panel Cutout

Mounted Separately

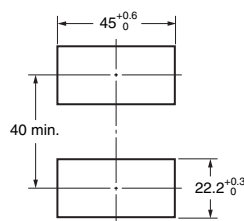

Group Mounted

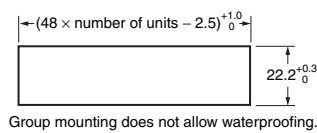

- Recommended panel thickness is 1 to 5 mm.
- Group mounting is not possible in the vertical direction. (Maintain the specified mounting space between Controllers.)
- To mount the Controller so that it is waterproof, insert the waterproof packing onto the Controller.
- When two or more Controllers are mounted, make sure that the surrounding temperature does not exceed the allowable operating temperature specified in the specifications.

E5GN-C Models with Screwless Clamp Terminal Blocks

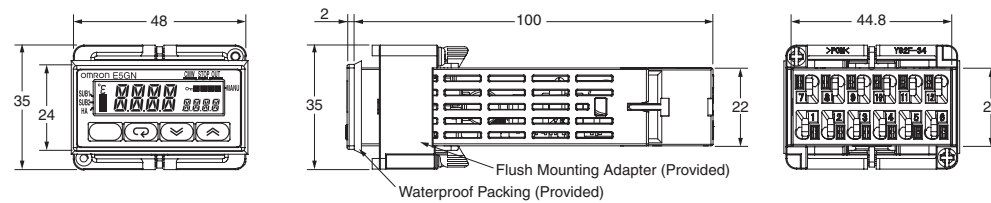

Panel Cutout

Mounted Separately

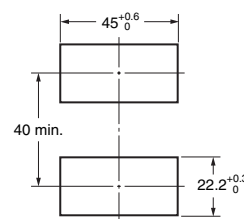

Group Mounted

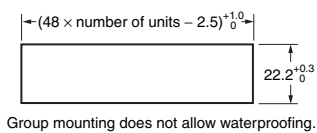

- Recommended panel thickness is 1 to 5 mm.
- Group mounting is not possible in the vertical direction. (Maintain the specified mounting space between Controllers.)
- When two or more Controllers are mounted, make sure that the surrounding temperature does not exceed the allowable operating temperature specified in the specifications.

Accessories (Order Separately)

USB-Serial Conversion Cable

E58-CIFQ1

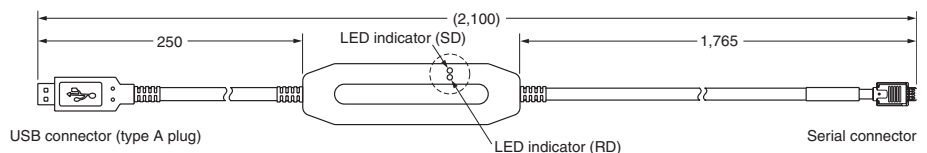

Waterproof Packing
Y92S-32 (for DIN 48 × 24)

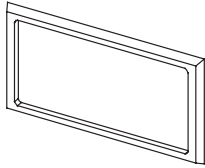

Order the Waterproof Packing separately if it becomes lost or damaged.
The Waterproof Packing can be used to achieve an IP66 degree of protection.
(Deterioration, shrinking, or hardening of the waterproof packing may occur depending on the operating environment. Therefore, periodic replacement is recommended to ensure the level of waterproofing specified in IP66. The time for periodic replacement depends on the operating environment. Be sure to confirm this point at your site. Consider one year a rough standard. OMRON shall not be liable for the level of water resistance if the customer does not perform periodic replacement.)
The Waterproof Packing does not need to be attached if a waterproof structure is not required.

Current Transformers

E54-CT1

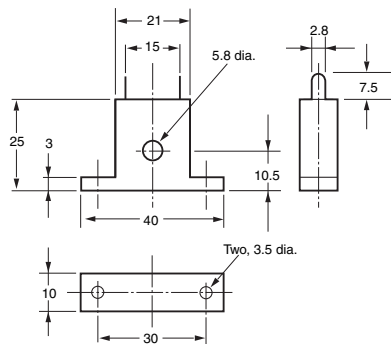
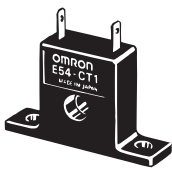

E54-CT1

Thru-current (Io) vs. Output Voltage (Eo) (Reference Values)

Maximum continuous heater current: 50 A (50/60 Hz)
Number of windings: 400±2
Winding resistance: 18±2 Ω

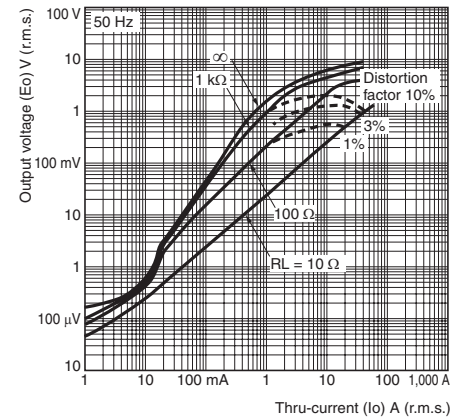

E54-CT3

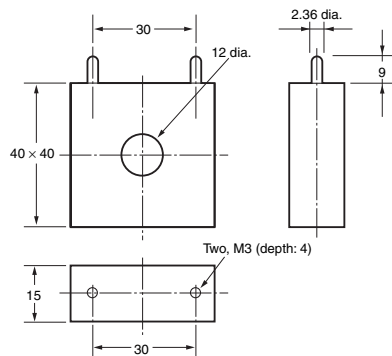

E54-CT3

Thru-current (Io) vs. Output Voltage (Eo) (Reference Values)

Maximum continuous heater current: 120 A (50/60 Hz)
(Maximum continuous heater current for the Temperature Controller is 50 A.)
Number of windings: 400±2
Winding resistance: 8±0.8 Ω

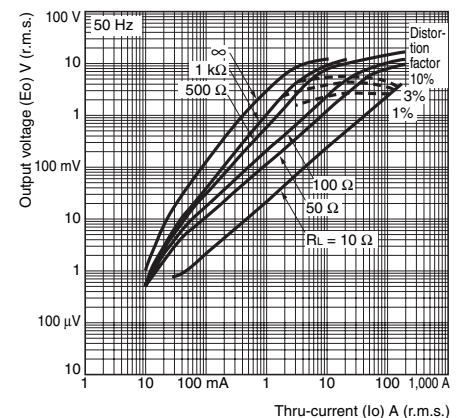

E54-CT3 Accessory

• Armature

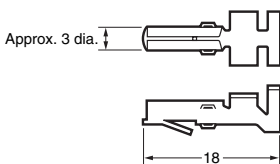

• Plug

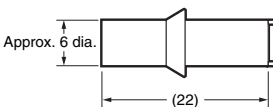

Connection Example

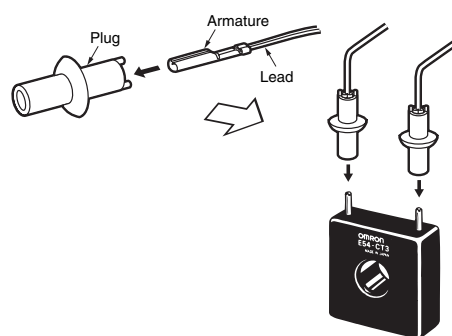

Read and Understand This Catalog

Please read and understand this catalog before purchasing the products. Please consult your OMRON representative if you have any questions or comments.

Warranty and Limitations of Liability

WARRANTY

OMRON's exclusive warranty is that the products are free from defects in materials and workmanship for a period of one year (or other period if specified) from date of sale by OMRON.

OMRON MAKES NO WARRANTY OR REPRESENTATION, EXPRESS OR IMPLIED, REGARDING NON-INFRINGEMENT, MERCHANTABILITY, OR FITNESS FOR PARTICULAR PURPOSE OF THE PRODUCTS. ANY BUYER OR USER ACKNOWLEDGES THAT THE BUYER OR USER ALONE HAS DETERMINED THAT THE PRODUCTS WILL SUITABLY MEET THE REQUIREMENTS OF THEIR INTENDED USE. OMRON DISCLAIMS ALL OTHER WARRANTIES, EXPRESS OR IMPLIED.

LIMITATIONS OF LIABILITY

OMRON SHALL NOT BE RESPONSIBLE FOR SPECIAL, INDIRECT, OR CONSEQUENTIAL DAMAGES, LOSS OF PROFITS OR COMMERCIAL LOSS IN ANY WAY CONNECTED WITH THE PRODUCTS, WHETHER SUCH CLAIM IS BASED ON CONTRACT, WARRANTY, NEGLIGENCE, OR STRICT LIABILITY.

In no event shall the responsibility of OMRON for any act exceed the individual price of the product on which liability is asserted.

IN NO EVENT SHALL OMRON BE RESPONSIBLE FOR WARRANTY, REPAIR, OR OTHER CLAIMS REGARDING THE PRODUCTS UNLESS OMRON'S ANALYSIS CONFIRMS THAT THE PRODUCTS WERE PROPERLY HANDLED, STORED, INSTALLED, AND MAINTAINED AND NOT SUBJECT TO CONTAMINATION, ABUSE, MISUSE, OR INAPPROPRIATE MODIFICATION OR REPAIR.

Application Considerations

SUITABILITY FOR USE

OMRON shall not be responsible for conformity with any standards, codes, or regulations that apply to the combination of products in the customer's application or use of the products.

At the customer's request, OMRON will provide applicable third party certification documents identifying ratings and limitations of use that apply to the products. This information by itself is not sufficient for a complete determination of the suitability of the products in combination with the end product, machine, system, or other application or use.

The following are some examples of applications for which particular attention must be given. This is not intended to be an exhaustive list of all possible uses of the products, nor is it intended to imply that the uses listed may be suitable for the products:

- Outdoor use, uses involving potential chemical contamination or electrical interference, or conditions or uses not described in this catalog.
- Nuclear energy control systems, combustion systems, railroad systems, aviation systems, medical equipment, amusement machines, vehicles, safety equipment, and installations subject to separate industry or government regulations.
- Systems, machines, and equipment that could present a risk to life or property.

Please know and observe all prohibitions of use applicable to the products.

NEVER USE THE PRODUCTS FOR AN APPLICATION INVOLVING SERIOUS RISK TO LIFE OR PROPERTY WITHOUT ENSURING THAT THE SYSTEM AS A WHOLE HAS BEEN DESIGNED TO ADDRESS THE RISKS, AND THAT THE OMRON PRODUCTS ARE PROPERLY RATED AND INSTALLED FOR THE INTENDED USE WITHIN THE OVERALL EQUIPMENT OR SYSTEM.

PROGRAMMABLE PRODUCTS

OMRON shall not be responsible for the user's programming of a programmable product, or any consequence thereof.

Disclaimers

CHANGE IN SPECIFICATIONS

Product specifications and accessories may be changed at any time based on improvements and other reasons.

It is our practice to change model numbers when published ratings or features are changed, or when significant construction changes are made. However, some specifications of the products may be changed without any notice. When in doubt, special model numbers may be assigned to fix or establish key specifications for your application on your request. Please consult with your OMRON representative at any time to confirm actual specifications of purchased products.

DIMENSIONS AND WEIGHTS

Dimensions and weights are nominal and are not to be used for manufacturing purposes, even when tolerances are shown.

PERFORMANCE DATA

Performance data given in this catalog is provided as a guide for the user in determining suitability and does not constitute a warranty. It may represent the result of OMRON's test conditions, and the users must correlate it to actual application requirements. Actual performance is subject to the OMRON Warranty and Limitations of Liability.

ERRORS AND OMISSIONS

The information in this document has been carefully checked and is believed to be accurate; however, no responsibility is assumed for clerical, typographical, or proofreading errors, or omissions.

2009.12

In the interest of product improvement, specifications are subject to change without notice.

OMRON Corporation
Industrial Automation Company

<http://www.ia.omron.com/>