

Absolute Rotary Encoder

E6CP

Absolute Rotary Encoders with Gray Code Output

- Gray code output decreases output errors
- Lightweight plastic housing
- Used with Omron's H8PS Cam Positioner, this encoder detects operation timing of various automatic machines with high precision
- Optical system eliminates brush noise and minimizes errors from temperature fluctuation compared with potentiometers



Ordering Information

■ ENCODERS

The encoder with a "-C" in the part number has a cable that terminates in a connector for Omron's H8PS Cam Positioner.

Resolution (pulses/revolution)	Output code	Output form	Supply voltage	Cable termination	Part number
8-bit (256 pulses/revolution)	Gray code	Open collector	5 to 12 VDC	Wire bundle	E6CP-AG3C
			12 to 24 VDC	Connector	E6CP-AG5C-C

■ ACCESSORIES

Description	Part number
Shaft coupler; fits two 6 mm (0.24 in) dia. shafts	E69-C06B
Extension cable, 5 m (16.40 ft) for E6CP-AG5C-C encoder	E69-DF5

■ REPLACEMENT PARTS

Description	Part number
Mounting brackets (set of 3) supplied with each E6CP encoder	E69-FCA-02

Specifications

Part number		E6CP-AG3C	E6CP-AG5C-C
Supply voltage		5 VDC -5% to 12 VDC +10%; max. 5% ripple peak-to-peak	12 VDC -10% to 24 VDC +15%; max. 5% ripple peak-to-peak
Current consumption		90 mA max.	70 mA max.
Resolution (pulses/revolution)		8-bit (256 pulses/revolution)	
Output code		Gray code (binary)	
Applicable Cam Positioner		—	H8PS
Output form		Open collector output	
Output capacity		Applied voltage: 28 VDC Residual voltage: 0.4 V max. at sink current Sink current: 16 mA max.	
Maximum response frequency		5 kHz	
Logic		Negative (H level: 0, L level: 1)	
Accuracy		Within $\pm 1^\circ$	
Rotation direction		Output code increases in clockwise direction when viewed from shaft	
Output rise and fall times		1.0 μ s max. with 16 V control output voltage, 1 k Ω load resistance and 2 m (6.56 ft) output cable	
Starting torque		10 g-cm (0.14 oz-inch) max.	
Shaft loading	Radial	3 kgf (21.7 ft•lbs)	
	Axial	2 kgf (14.5 ft•lbs)	
Moment of inertia		10 g-cm ² (0.055 oz-inch ²) max.	
Maximum rpm		1,000 rpm	
Electrical connection		Prewired with 2 m (6.56 ft) length cable	Connector
Weight		Approx. 200 g (7 oz)	
Enclosure rating		IEC: IP50	
Ambient temperature	Operating Storage	-10°C to 55°C (14°F to 131°F) -25°C to 80°C (-13°F to 176°F)	
Ambient humidity		35% to 85% RH	
Vibration resistance		Mechanical durability: 10 to 55 Hz, 1.5 mm double amplitude, in X, Y, and Z directions for 2 hours each	
Shock resistance		Mechanical durability: approx. 100 G in X, Y, and Z directions, 3 times each	
Insulation resistance		10 M Ω minimum at 500 VDC between current-carrying part and housing	
Dielectric strength		500 VAC, 50/60 Hz for 1 minute between current-carrying part and housing	

Operation

■ OUTPUT CIRCUIT DIAGRAM

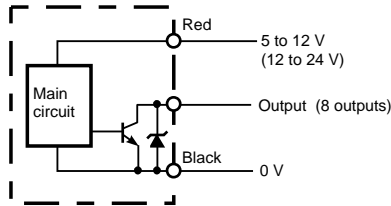

Wiring

Terminal no.	E6CP-AG5C-C	Wire color	EC6P-AG3C
1	—	Red	+ power supply
2	—	Black	0V (common)
3	Output 2 ⁵	Brown	Output 2 ⁰
4	Output 2 ¹	Orange	Output 2 ¹
5	Output 2 ⁰	Yellow	Output 2 ²
6	Output 2 ⁷	Green	Output 2 ³
7	Output 2 ⁴	Blue	Output 2 ⁴
8	Output 2 ²	Purple	Output 2 ⁵
9	Output 2 ³	Gray	Output 2 ⁶
10	Output 2 ⁶	White	Output 2 ⁷
11	GND		
12	Power supply 12 to 24 V		
13	0 V (common)		

Notes:

1. The output of each bit is from the same circuit.
2. Terminals no. 1 and no. 2 are short-circuited.

■ TIMING CHART

Shaft rotation: Clockwise as viewed from the shaft

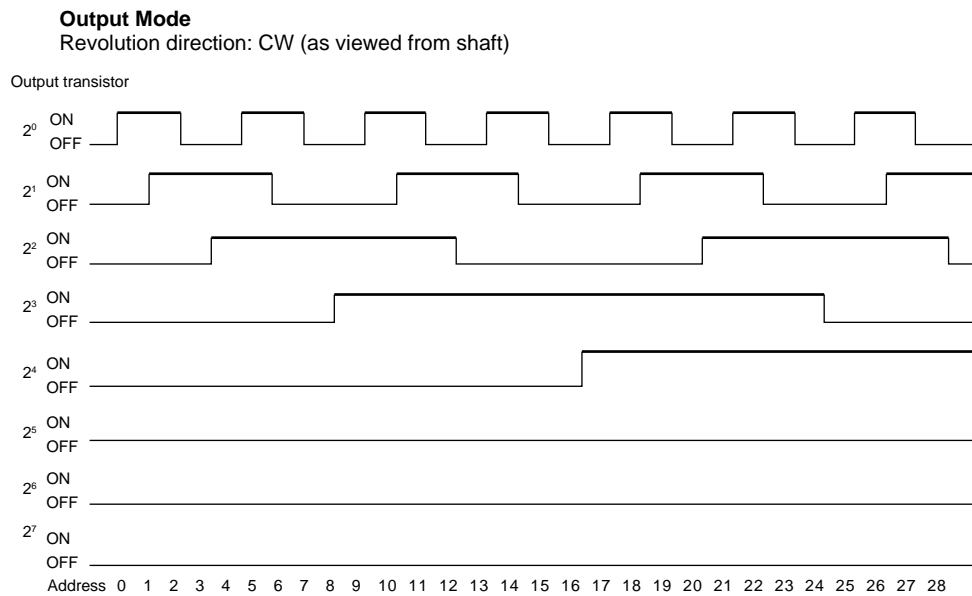

Dimensions

Unit: mm (inch)

ENCODERS

E6CP-AG3C

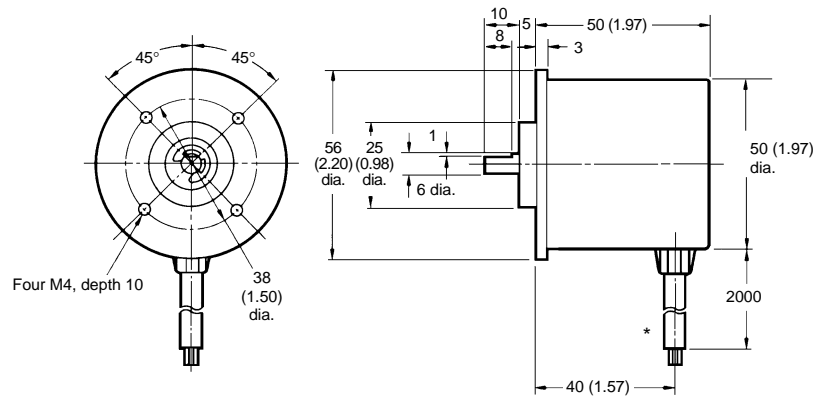
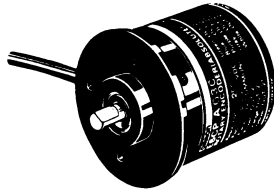

E6CP-AG5C-C

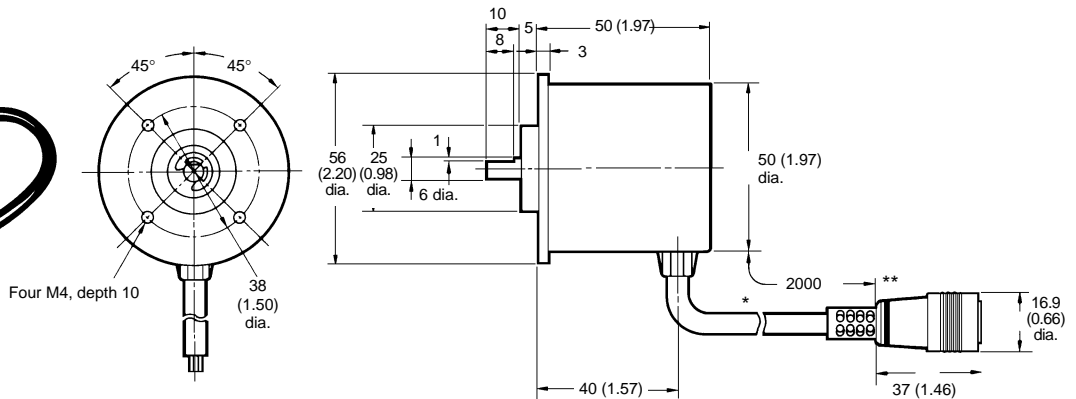
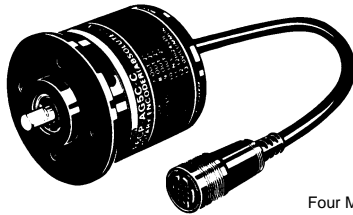

Note:

* Oil-resistant, vinyl-insulated and shielded cable is 2 m (6.56 ft) long. The E6CP-AG3C encoder terminates with a 6 mm OD wire bundle.

**E6CP-AG5C-C encoder terminates in a connector that fits the H8PS Cam Positioner.

MOUNTING BRACKET E69-FCA-02

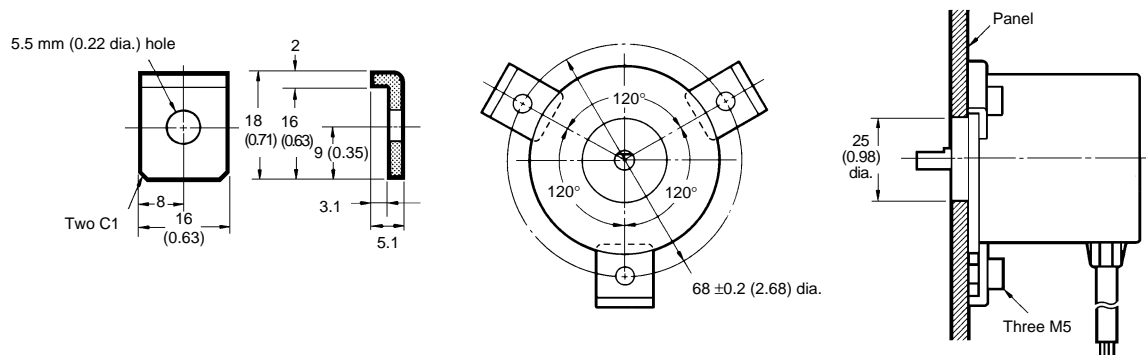

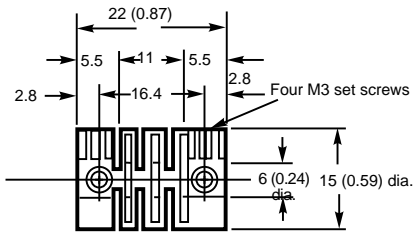
■ ACCESSORIES**Shaft Coupler E69-C06B****Note:**

1. Material: Glass-filled polybutadiene terephthalate (PBT).
2. Each set screw must be tightened to 2.5 kg-cm (2.17 in-lbs.)

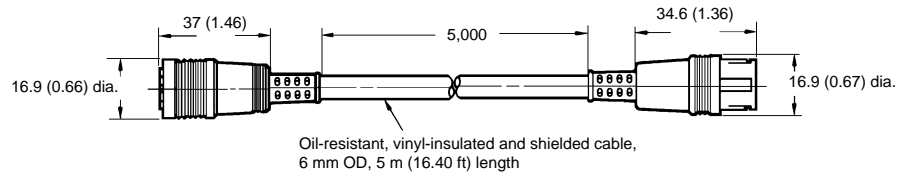
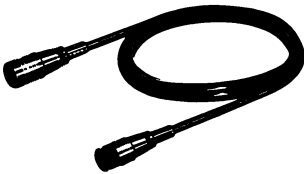
Extension Cable E69-DF5

NOTE: DIMENSIONS ARE SHOWN IN MILLIMETERS. To convert millimeters to inches divide by 25.4.

OMRON

OMRON ELECTRONICS, INC.

One East Commerce Drive
Schaumburg, IL 60173

1-800-55-OMRON

6
Cat. No. CEDSAX3

10/99

Specifications subject to change without notice.

OMRON CANADA, INC.

885 Milner Avenue
Scarborough, Ontario M1B 5V8

416-286-6465

Printed in the U.S.A. www.DataSheet4U.com