

EB 41 Double diode

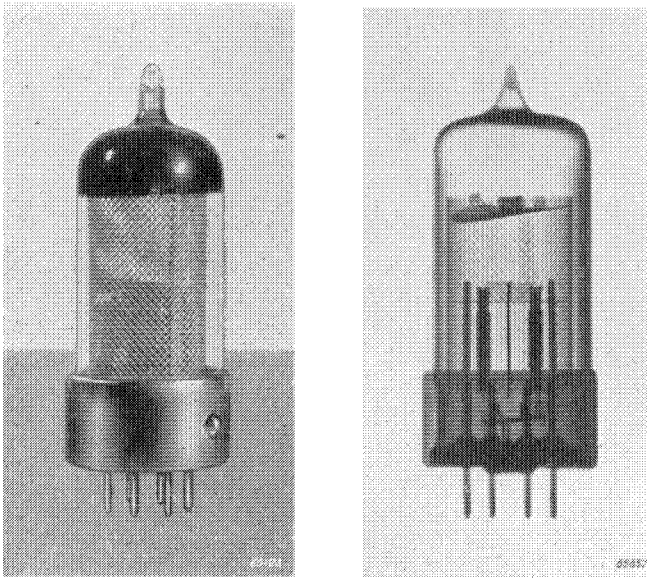

Fig. 1

Normal and X-ray photographs of the EB 41 (approximately actual size).

The EB 41 comprises two separate, indirectly heated diodes screened from each other; only the heaters are interconnected. The advantage of this design is that neither diode in any way affects the other, whilst the low inter-electrode capacitance and low internal resistance render this valve eminently suitable for television and F.M. receivers. For instance, to obtain a television picture with sufficient detail, it is essential that the highest modulation frequencies are not attenuated during detection of the signal; furthermore, to prevent picture distortion, the phase displacement of the detected voltages should be as nearly as possible proportional to the frequency. Both these conditions can be fulfilled if the detector loading resistance is kept low, which means that the internal resistance of the diode must also be low. The EB 41 is therefore an excellent valve for use in such detector circuits. If one diode of the EB 41 is used as detector in a television receiver, the other is still available for use as a so-called D.C. restorer. If the picture signal is detected and amplified in the normal manner, the brightness of the picture appearing on the C.R. tube is not at the correct brightness level. This can be rectified by means of a D.C. voltage, obtained by using the D.C. restorer diode to detect the I.F. signal.

In addition to these applications of the EB 41, it can be used as signal limiter and detector in F.M. receivers, whilst in ordinary broadcast receivers it will give better results than the conventional diodes.

EB 41

TECHNICAL DATA OF THE DOUBLE DIODE EB 41

Heater data

Heating : indirect, A.C. or D.C., series or parallel feed

Heater voltage	V_f	=	6.3 V
Heater current	I_f	=	0.3 A

Capacitances (cold valve)

Anode - cathode, first diode	C_{d1}	=	3.6 pF
Anode - cathode, second diode	C_{d2}	=	3.6 pF
Cathode - other electrodes, first diode	C_{k1}	=	4.5 pF
Cathode - other electrodes, second diode	C_{k2}	=	4.5 pF
Diode anode - diode anode	C_{d1d2}	<	0.03 pF

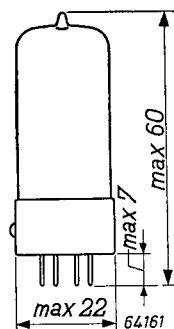
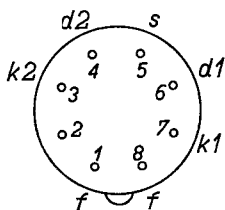
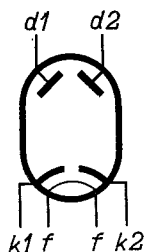

Fig. 2

Electrode arrangement, electrode connections and dimensions (in mm) of the EB 41.

Limiting values for use as half-wave rectifier (for each section)

Transformer voltage	V_{tr}	= max.	150 V_{RMS}
Output current	I_o	= max.	9 mA
Input capacitance of smoothing filter	C_{fnt}	= max.	8 μF
Total resistance in anode circuit	R_t	= min.	300 Ω
Voltage between heater and cathode	V_{fkp} (k pos., f neg.)	= max.	330 V ¹⁾

Limiting values (for each system)

Peak inverse voltage at the diode	$V_{d inv p}$	= max.	420 V
Diode current	I_d	= max.	9 mA
Peak diode current	I_{dp}	= max.	54 mA

¹⁾ Max. 200 V D.C. + max. 165 V A.C. (RMS-value).

Voltage between heater and cathode	V_{fk}	= max. 150 V
Voltage between heater and cathode (cathode positive with respect to heater)	V_{fkp} (k pos., f neg.)	= max. 330 V ¹⁾
External resistance between heater and cathode	R_{fk}	= max. 20 k Ω

¹⁾ Max. 200 V D.C. + max. 165 V A.C. (RMS-value).

Application of the EB 41 in television receivers

In Fig. 3 the diode D_1 is shown connected as a detector in a television receiver ; the load is provided by the resistor R_1 (approx. 4 k Ω), whilst C_1 is the detector capacitor (10 - 20 pF). The coil L_1 , connected in series with R_1 , works in conjunction with coil L_2 to compensate parasitic capacitances, thus making it possible to pass the necessary bandwidth to about 4 Mc/s. The diode D_2 functions as a D.C. restorer. Since the object in this case is to obtain a D.C. voltage, a high RC time constant is permissible. The load is formed by a potentiometer comprising resistors R_2 in parallel with capacitor C_2 , and R_3 in parallel with C_3 . The D.C. voltage across R_3 is applied through L_1 , R_1 and L_2 to the control grid of the next valve and so provides this valve with sufficient bias to ensure correct picture brightness.

In the arrangement shown in Fig. 3 the bias for the next valve is reduced ; if a more negative bias is required the anode and cathode connections of the EB 41 must be interchanged.

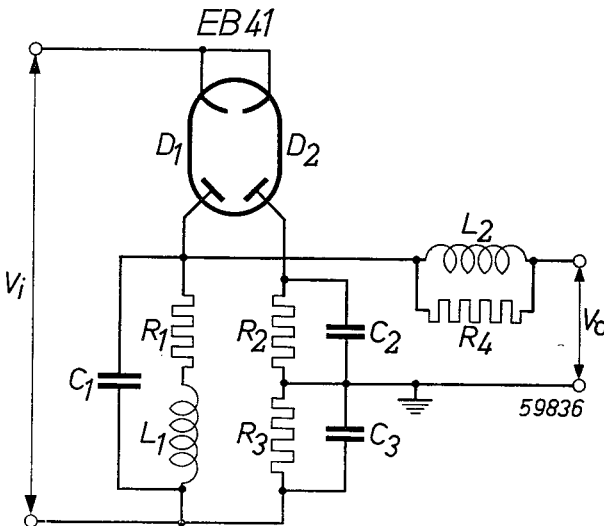

Fig. 3
The EB 41 used as detector diode and D.C. restorer in a television receiver.

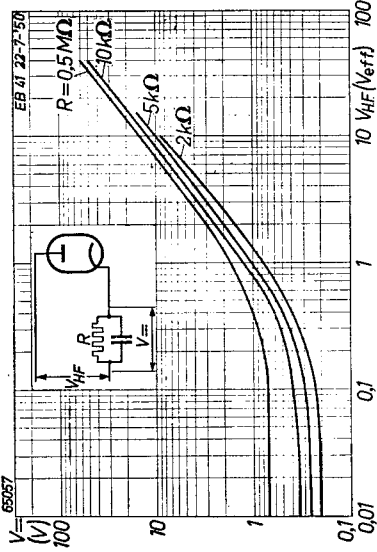

Fig. 5

The detected D.C. voltage ($V =$) of each section of the EB 41, as a function of the H.F. input signal (V_{HF}) for various values of the load resistance (R).

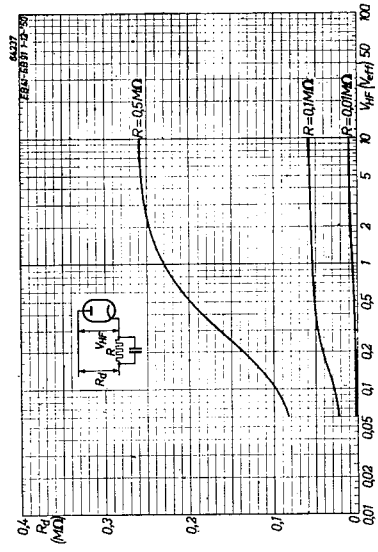

Fig. 6

Diode damping resistance (R_d), as a function of the H.F. input signal (V_{HF}) for various values of the diode load resistance (R).

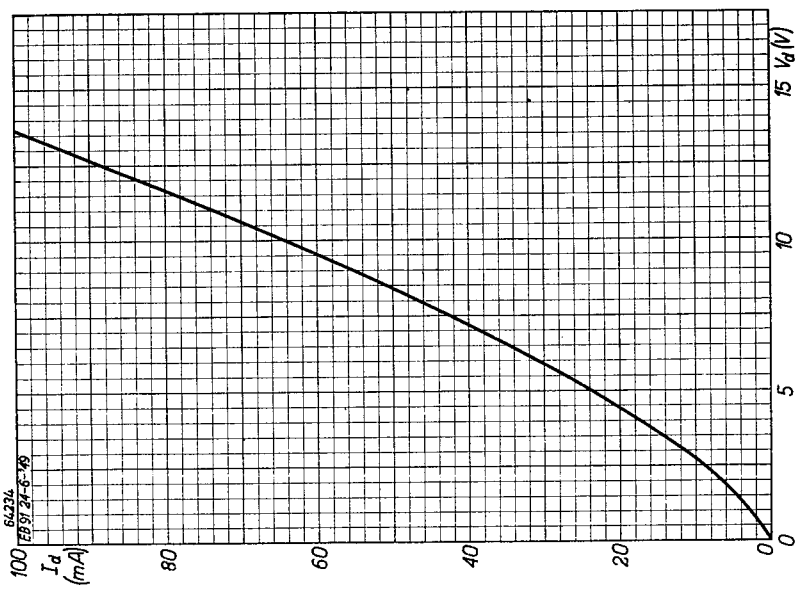

Fig. 4

The current I_d of each system of the EB 41, as a function of the voltage V_d .