

EBF 80 Double diode-variable-mu pentode

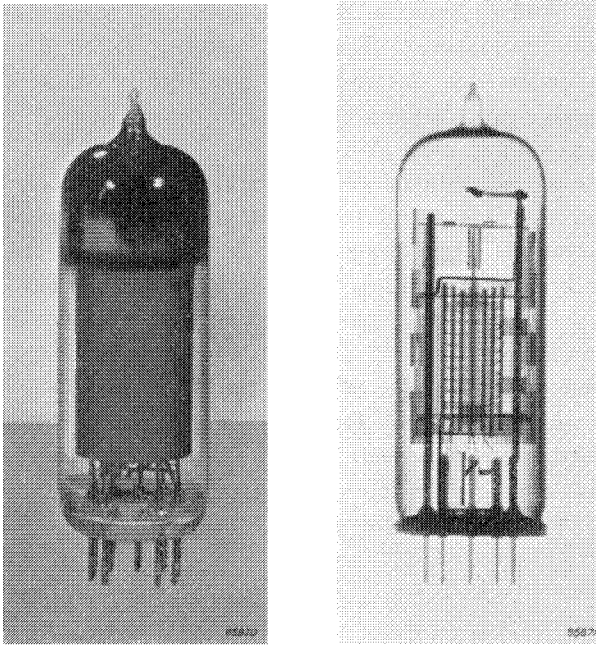

Fig. 1
Normal and X-ray photographs of the EBF 80.

The EBF 80 comprises a pentode section with a variable- μ characteristic and two diodes operating on a common cathode. The pentode system is suitable for R.F., I.F. or A.F. amplification, the slope being 2.2 mA/V, and the internal resistance 1.4 M Ω , for a grid bias of -2 V. The two diodes can be used for detection and as a voltage source for automatic gain control. In view of the fact that this valve has two diodes, it is particularly suitable for receivers containing no other diodes: delayed A.G.C. can thus be employed without any difficulty with all the advantages mentioned in the description of the EAF 42.

Examples of receivers in which the EBF 80 can be used with advantage as I.F. amplifier are as follows:

1. Simple receivers without an A.F. amplifying valve, employing, for example, the ECH 42 or ECH 41 as the frequency changer and the EL 41 as the output valve.
2. Push-pull receivers with the ECC 40 as an A.F. amplifier and phase inverter.
3. Sets in which the EF 40 is used as an A.F. amplifying valve, ensuring high A.F. amplification with low hum level and little risk of microphony.

EBF 80

- Sets suitable for receiving A.M. as well as F.M. signals, employing the EQ 80 as F.M. detector. For A.M. reception, the EQ 80 can be used as an A.F. amplifier, with the two diodes of the EBF 80 as detector and A.G.C. diode.

In order to avoid undesirable coupling, suitable screens are fitted between the diodes and the pentode section and between the electrodes of the pentode. The whole is enclosed in a screening cage to protect the valve from external influences, thus obviating the necessity for external screening.

When used as an A.F. amplifier, the EBF 80 provides a gain of 150, which represents more amplification than is usually required, and so leaves a reserve which can be used for feedback purposes. Moreover, the gain in an amplifier or receiver is usually limited by microphony; unless special precautions are taken, the gain cannot be allowed to reach a value such that, using a loudspeaker of 5% efficiency, the input signal applied to the EBF 80 is less than 25 mV for an output of 50 mW from the output valve. The full significance of this is explained in the description of the valve EAF 42.

TECHNICAL DATA OF THE DOUBLE DIODE-PENTODE EBF 80

Heater data

Heating: indirect by A.C. or D.C.; parallel feed

Heater voltage	V_f	=	6.3 V
Heater current	I_f	=	0.3 A

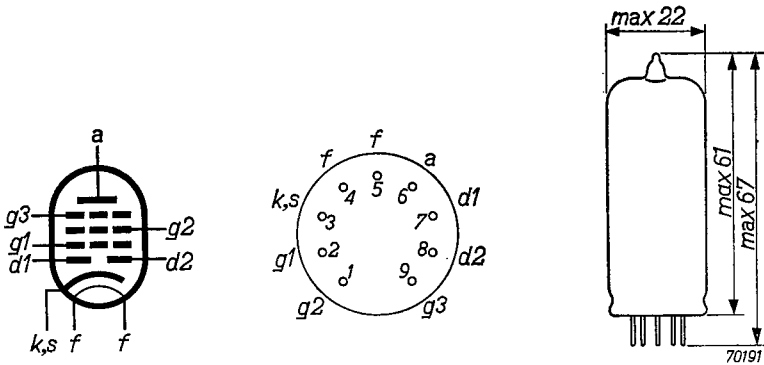

Fig. 2
Electrode arrangement, electrode connections and max. dimensions in mm of the EBF 80

Capacitances

Pentode section

Input capacitance	C_{g1}	=	4.2 pF
Output capacitance	C_a	=	4.9 pF
Control grid - anode.	C_{ag1}	<	0.0025 pF
Control grid - heater.	C_{g1f}	<	0.07 pF

Diode system

Diode 1 - cathode.	C_{d1}	=	2.2 pF
Diode 2 - cathode.	C_{d2}	=	2.35 pF
Between the diode anodes	C_{d1d2}	<	0.35 pF
Diode 1 - heater	C_{d1f}	<	0.02 pF
Diode 2 - heater	C_{d2f}	<	0.005 pF

Between the diodes and the pentode section

Diode 1 - control grid	C_{d1g1}	<	0.0008 pF
Diode 2 - control grid	C_{d2g1}	<	0.001 pF
Diode 1 - pentode anode	C_{d1a}	<	0.2 pF
Diode 2 - pentode anode	C_{d2a}	<	0.05 pF

Operating characteristics of the pentode section as R.F. or I.F. amplifier

Anode and supply voltage	$V_a = V_b$	=	250 V
Voltage on grid 3	V_{g3}	=	0 V
Screen grid resistor	R_{g2}	=	95 kΩ
Cathode resistor	R_k	=	295 Ω
Grid bias	V_{g1}	=	$\overbrace{-2 \text{ } -41.5}^{\text{V}}$
Screen grid voltage	V_{g2}	=	85 250 V
Anode current	I_a	=	5.0 — mA
Screen grid current	I_{g2}	=	1.75 — mA
Mutual conductance	S	=	2200 22 μA/V
Internal resistance	R_i	=	1.4 >10 MΩ
Amplification factor of grid No. 2 with respect to grid No. 1	μ_{g2g1}	=	18 18
Equivalent noise resistance	R_{eq}	=	6.8 — kΩ

EBF 80

Operating characteristics of the pentode section as a resistance-capacity coupled A.F. amplifier

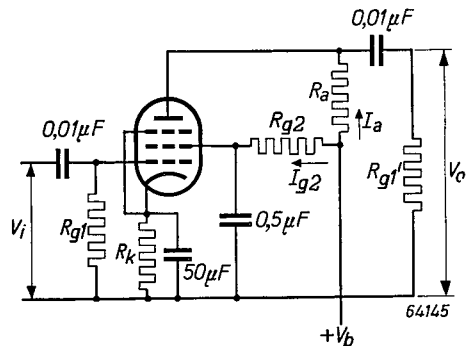

Fig. 3

Supply voltage	V_b	=	250	250	250	250	V
Anode resistor	R_a	=	0.22	0.1	0.22	0.1	MΩ
Screen grid resistor	R_{g2}	=	0.82	0.39	1.0	0.47	MΩ
Grid leak	R_{g1}	=	1	1	10	10	MΩ
Cathode resistor	R_k	=	1800	1000	0	0	Ω
Grid leak of next valve	R'_{g1}	=	0.68	0.33	0.68	0.33	MΩ
Anode current	I_a	=	0.75	1.5	0.75	1.5	mA
Screen grid current	I_{g2}	=	0.30	0.53	0.25	0.50	mA
Amplification	V_0/V_i	=	110	80	160	110	
Distortion d_{tot} at an output							
voltage of	3 V_{RMS}	=	0.75	0.9	0.8	0.8	%
	5 V_{RMS}	=	1.3	1.5	1.4	1.4	%
	8 V_{RMS}	=	2.0	2.2	2.1	2.1	%

Operating characteristics of the pentode section as a resistance-capacity coupled A.F. amplifier, triode-connected (screen grid connected to anode)

Supply voltage	V_b	=	250	250	250	250	V
Anode resistor	R_a	=	0.1	0.047	0.1	0.047	MΩ
Grid leak	R_{g1}	=	1	1	10	10	MΩ
Cathode resistor	R_k	=	820	560	0	0	Ω
Grid leak of next valve	R'_{g1}	=	0.33	0.15	0.33	0.15	MΩ
Anode current	I_a	=	2.08	4.10	2.16	4.50	mA
Amplification	V_0/V_i	=	14	13	15	15	
Distortion d_{tot} at an output							
voltage of	3 V_{RMS}	=	1.6	1.3	2.0	1.7	%
	5 V_{RMS}	=	2.5	2.0	3.1	2.7	%
	8 V_{RMS}	=	4.3	2.9	4.8	4.1	%

Limiting values of the pentode section

Anode voltage, valve biased to cut-off	V_{a_o}	= max.	550 V
Anode voltage	V_a	= max.	300 V
Anode dissipation	W_a	= max.	1.5 W
Screen grid voltage, in cut-off condition	V_{g2_o}	= max.	550 V
Screen grid voltage, valve controlled	$V_{g2}(I_a < 2.5 \text{ mA})$	= max.	300 V
Screen grid voltage, valve uncontrolled	$V_{g2}(I_a = 5 \text{ mA})$	= max.	125 V
Screen grid dissipation	W_{g2}	= max.	0.3 W
Cathode current	I_k	= max.	10 mA
Grid current starting point	$V_{g1}(I_{g1} = +0.3 \text{ } \mu\text{A})$	= max.	-1.3 V
External resistance between control grid and cathode	R_{g1}	= max.	3 M Ω ¹⁾
External resistance between heater and cathode	R_{fk}	= max.	20 k Ω
Voltage between heater and cathode	V_{fk}	= max.	100 V

Limiting values of the diode sections

Peak inverse voltage on diode No. 1	$V_{d1inv p}$	= max.	350 V
Peak inverse voltage on diode No. 2	$V_{d2inv p}$	= max.	350 V
Current to diode anode No. 1	I_{d1}	= max.	0.8 mA
Current to diode anode No. 2	I_{d2}	= max.	0.8 mA
Peak current to diode anode No. 1	I_{d1p}	= max.	5 mA
Peak current to diode anode No. 2	I_{d2p}	= max.	5 mA
External resistance between heater and cathode	R_{fk}	= max.	20 k Ω
Voltage between heater and cathode	V_{fk}	= max.	100 V

¹⁾ Applicable where grid bias is obtained from cathode resistor; if a grid leak provides the grid bias, the limiting value for R_{g1} is 22 M Ω .

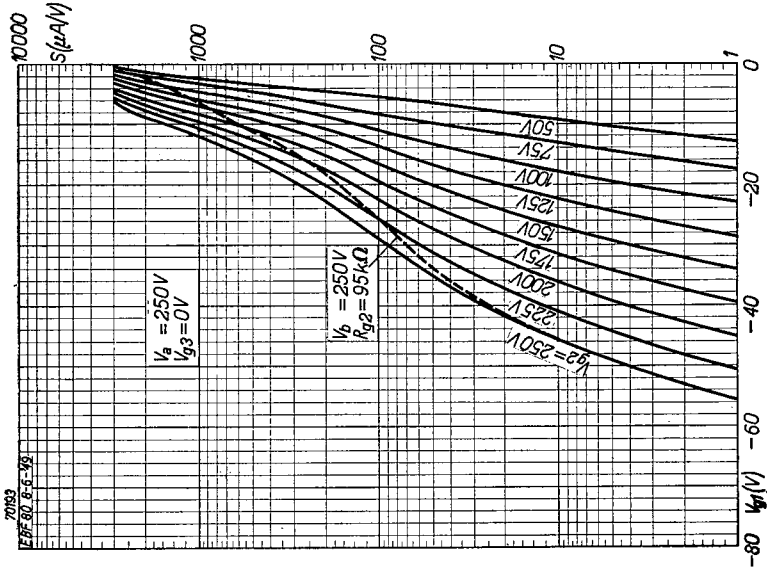

Fig. 5

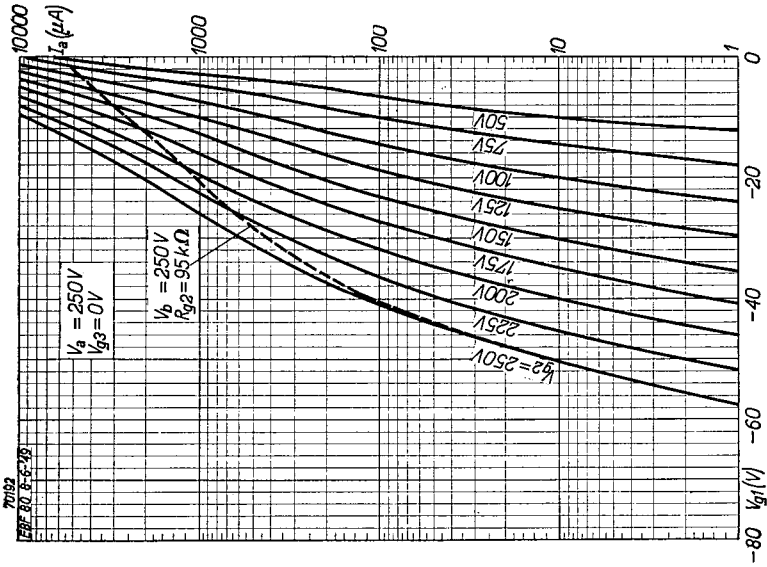

Fig. 4

Anode current (I_a , Fig. 4) and mutual conductance (S , Fig. 5) as functions of the grid bias (V_{g1}), with screen grid voltage (V_{g2}) as parameter. The broken lines represent I_a and S when a series resistor of 95 kΩ is included in the screen grid circuit.

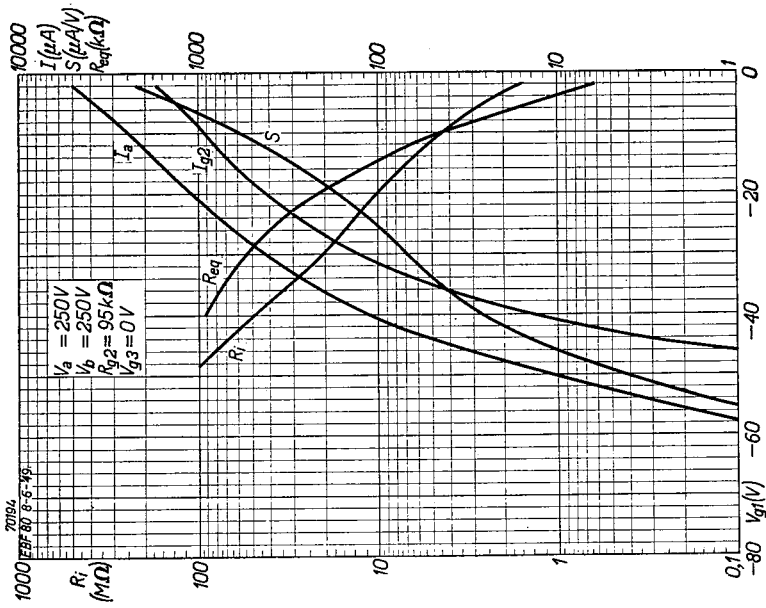

Fig. 6

Anode current (I_a), screen grid current (I_{g2}), mutual conductance (S), internal resistance (R_i) and equivalent noise resistance (R_{eq}) as functions of the grid bias (V_{g1}), with $R_{g2} = 95 \text{ k}\Omega$ in the screen grid circuit.

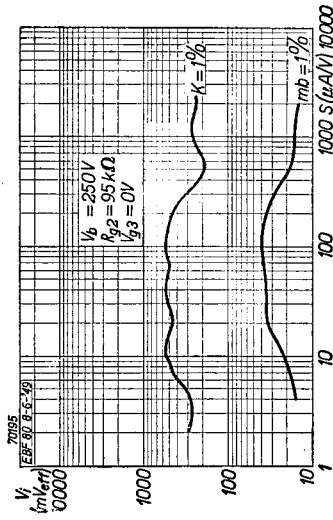

Fig. 7

- 1) Strength of an interfering signal (V_i) at the control grid producing 1% cross-modulation (curve $K=1\%$), and
- 2) strength of a ripple voltage (V_i) at the control grid producing 1% modulation hum (curve $m_b=1\%$), both as functions of the slope (S).

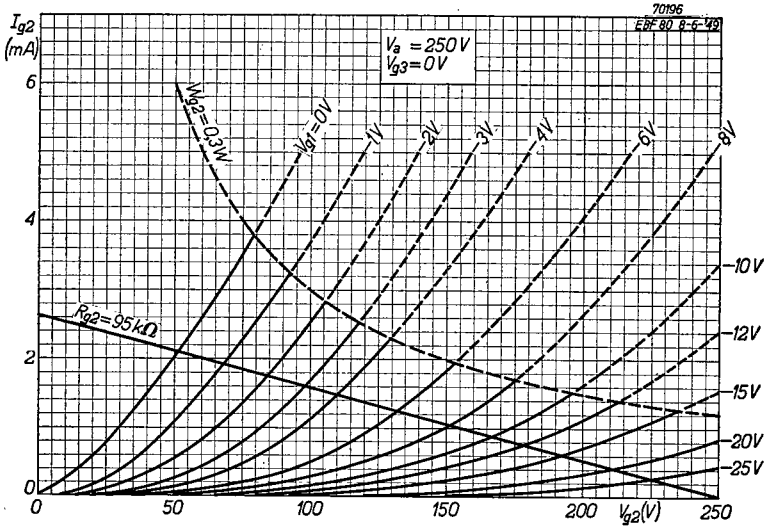

Fig. 8
Screen grid current (I_{g2}) as a function of the screen grid voltage (V_{g2}) with grid bias (V_{g1}) as parameter. The broken curve indicates the maximum permissible screen grid dissipation ($W_{g2} = 0.3W$), whilst the straight line represents the load line with a series resistor of $95k\Omega$.