



# EC1019B

## InGaP HBT Gain Block

### Product Features

- DC – 4 GHz
- +19.5 dBm P1dB at 2 GHz
- +31 dBm OIP3 at 2 GHz
- 18.5 dB Gain at 2 GHz
- 2.8 dB Noise Figure
- Available in Lead-free / green SOT-89 Package Style
- Internally matched to 50  $\Omega$

### Applications

- Mobile Infrastructure
- CATV / FTTH
- W-LAN / ISM
- RFID
- WiMAX / WiBro

### Product Description

The EC1019B is a general-purpose buffer amplifier that offers high dynamic range in a low-cost surface-mount package. At 2000 MHz, the EC1019B typically provides 18.5 dB of gain, +31 dBm Output IP3, and +19.5 dBm P1dB.

The EC1019B consists of Darlington pair amplifiers using the high reliability InGaP/GaAs HBT process technology and only requires DC-blocking capacitors, a bias resistor, and an inductive RF choke for operation. The device is ideal for wireless applications and is available in low-cost, surface-mountable plastic lead-free/green/RoHS-compliant SOT-89 packages. A SOT-86 version is also available as the EC1019C. All devices are 100% RF and DC tested.

The broadband MMIC amplifier can be directly applied to various current and next generation wireless technologies such as GPRS, GSM, CDMA, and W-CDMA. In addition, the EC1019B will work for other various applications within the DC to 4 GHz frequency range such as CATV and mobile wireless.

### Functional Diagram

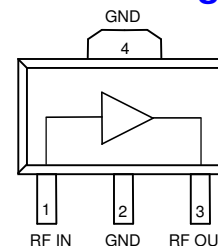

Function	Pin No.
Input	1
Output/Bias	3
Ground	2, 4

### Specifications <sup>(1)</sup>

Parameter	Units	Min	Typ	Max
Operational Bandwidth	MHz	DC		4000
Test Frequency	MHz		2000	
Gain	dB	16.5	18.4	20.5
Input Return Loss	dB		16.5	
Output Return Loss	dB		10.5	
Output P1dB	dBm	+14.5	+19.5	
Output IP3 <sup>(2)</sup>	dBm		+31	
Noise Figure	dB		2.9	
Device Voltage	V	4.2	4.7	5.2
Device Current	mA		70	

1. Test conditions unless otherwise noted: 25 °C, Supply Voltage = +6V, Rbias = 16.5 $\Omega$ , 50 $\Omega$  system.
2. 3OIP measured with two tones at an output power of +4 dBm/tone separated by 1 MHz. The suppression on the largest IM3 product is used to calculate the 3OIP using a 2:1 rule.

### Typical Performance <sup>(1)</sup>

Parameter	Units	Typical			
Frequency	MHz	500	900	1900	2140
S21	dB	20.9	20.4	18.5	18.2
S11	dB	-21.5	-19.2	-16.6	-16.9
S22	dB	-17.3	-15.1	-10.6	-10.2
Output P1dB	dBm	+19	+19	+19.5	+19
Output IP3 <sup>(2)</sup>	dBm	+34	+34	+31	+31
Noise Figure	dB	2.5	2.6	2.8	2.9

### Absolute Maximum Rating

Parameter	Rating
Operating Case Temperature	-40 to +85 °C
Storage Temperature	-55 to +150 °C
Device Current	130 mA
RF Input Power (continuous)	+12 dBm
Junction Temperature	+250 °C

Operation of this device above any of these parameters may cause permanent damage.

### Ordering Information

Part No.	Description
EC1019B-G	InGaP HBT Gain Block (lead-free/green/RoHS-compliant SOT-89 package)
EC1019B-PCB	700 – 2400 MHz Fully Assembled Eval. Board



# EC1019B

InGaP HBT Gain Block

## Typical Device RF Performance

Supply Bias = +6 V,  $R_{bias} = 15 \Omega$ ,  $I_{cc} = 70 \text{ mA}$

Frequency	MHz	100	500	900	1900	2140	2400	3500	5800
S21	dB	21.2	20.9	20.4	18.5	18.2	17.6	15.6	11.3
S11	dB	-23.7	-21.5	-19.2	-16.6	-16.9	-18.2	-11.2	-9.5
S22	dB	-19.0	-17.3	-15.1	-10.6	-10.2	-10.2	-8.1	-6.2
Output P1dB	dBm	+19.4	+19.4	+19.4	+19.5	+19.0	+18.8	+16.2	
Output IP3	dBm	+33	+33.2	+33.6	+31	+31	+30.7		
Noise Figure	dB	2.9	2.5	2.6	2.8	2.9			

1. Test conditions: T = 25°C, Supply Voltage = +6 V, Device Voltage = 4.7 V,  $R_{bias} = 16.5 \Omega$ ,  $I_{cc} = 70 \text{ mA}$  typical, 50  $\Omega$  System.
2. 3OIP measured with two tones at an output power of +4 dBm/tone separated by 1 MHz. The suppression on the largest IM3 product is used to calculate the 3OIP using a 2:1 rule.
3. Data is shown as device performance only. Actual implementation for the desired frequency band will be determined by external components shown in the application circuit.

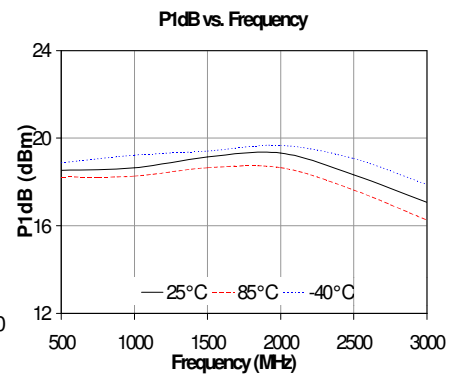
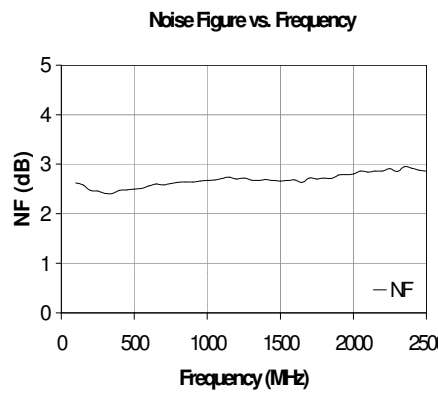
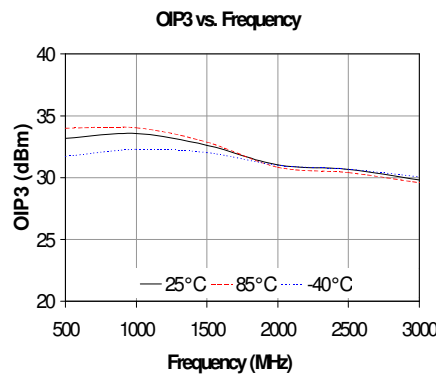
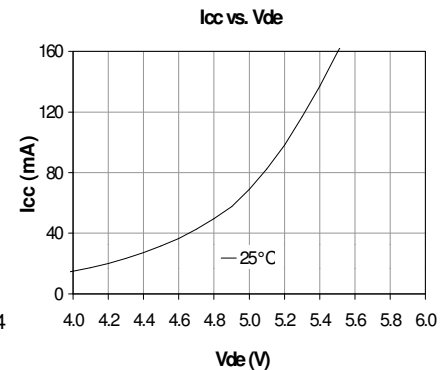
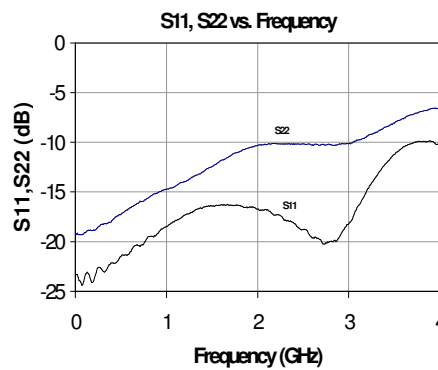



# EC1019B

InGaP HBT Gain Block

## Recommended Application Circuit

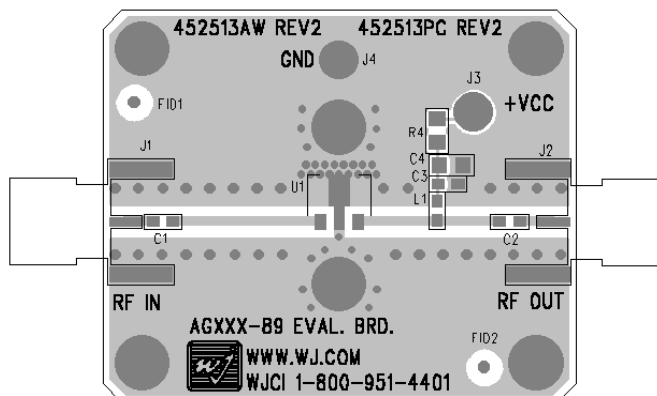
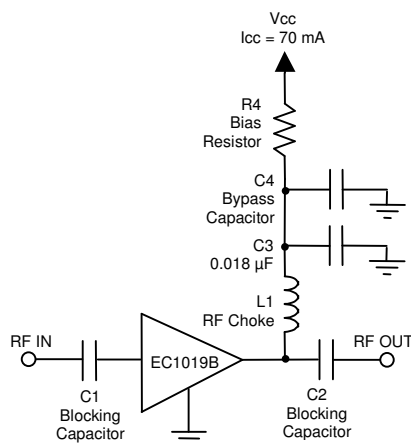

Recommended Component Values

Reference Designator	Frequency (MHz)						
	50	500	900	1900	2200	2500	3500
L1	820 nH	220 nH	68 nH	27 nH	22 nH	18 nH	15 nH
C1, C2, C4	.018 μF	1000 pF	100 pF	68 pF	68 pF	56 pF	39 pF

- The proper values for the components are dependent upon the intended frequency of operation.
- The following values are contained on the evaluation board to achieve optimal broadband performance:

Ref. Desig.	Value / Type	Size
L1	39 nH wirewound inductor	0603
C1, C2	56 pF chip capacitor	0603
C3	0.018 μF chip capacitor	0603
C4	Do Not Place	
R4	15 Ω 1% tolerance	0805

Recommended Bias Resistor Values

Supply Voltage	R1 value	Size
6 V	16.4 ohms	0805
7 V	30.7 ohms	1210
8 V	45 ohms	1210
9 V	59 ohms	2010
10 V	74 ohms	2010
12 V	102 ohms	2512

The proper value for R1 is dependent upon the supply voltage and allows for bias stability over temperature. WJ recommends a minimum supply bias of +6 V. A 1% tolerance resistor is recommended.

## Typical Device S-Parameters

S-Parameters ( $V_{\text{device}} = +4.7 \text{ V}$ ,  $I_{\text{CC}} = 70 \text{ mA}$ ,  $T = 25 \text{ }^\circ\text{C}$ , calibrated to device leads)

Freq (MHz)	S11 (dB)	S11 (ang)	S21 (dB)	S21 (ang)	S12 (dB)	S12 (ang)	S22 (dB)	S22 (ang)
50	-23.95	-10.27	21.26	177.77	-23.34	1.00	-19.31	-6.11
500	-21.49	-53.11	20.93	159.51	-23.02	8.39	-17.25	-58.78
1000	-18.50	-96.14	20.23	141.23	-22.37	14.81	-14.71	-100.42
1500	-16.41	-136.32	19.32	124.62	-21.62	19.01	-12.45	-132.99
2000	-16.74	-169.66	18.38	110.93	-20.72	22.20	-10.32	-161.53
2500	-18.80	170.71	17.40	95.50	-19.86	22.10	-10.16	167.27
3000	-18.23	-170.30	16.26	86.90	-19.10	22.75	-10.15	154.27
3500	-11.23	156.68	15.62	73.24	-18.20	21.01	-8.08	139.29
4000	-10.23	101.48	14.56	67.04	-17.79	19.02	-6.62	107.37
4500	-15.66	57.53	14.06	52.87	-17.02	14.17	-7.84	82.18
5000	-15.34	96.95	12.53	44.96	-16.79	10.83	-8.00	69.95
5500	-10.30	75.00	12.25	30.08	-16.32	6.34	-6.73	57.27
6000	-8.84	47.92	11.61	22.08	-15.68	4.21	-5.91	36.46

Device S-parameters are available for download off of the website at: <http://www.wj.com>



# EC1019B

InGaP HBT Gain Block

## EC1019B-G Mechanical Information

This package is lead-free/Green/RoHS-compliant. The plating material on the leads is NiPdAu. It is compatible with both lead-free (maximum 260 °C reflow temperature) and leaded (maximum 245 °C reflow temperature) soldering processes.

### Outline Drawing

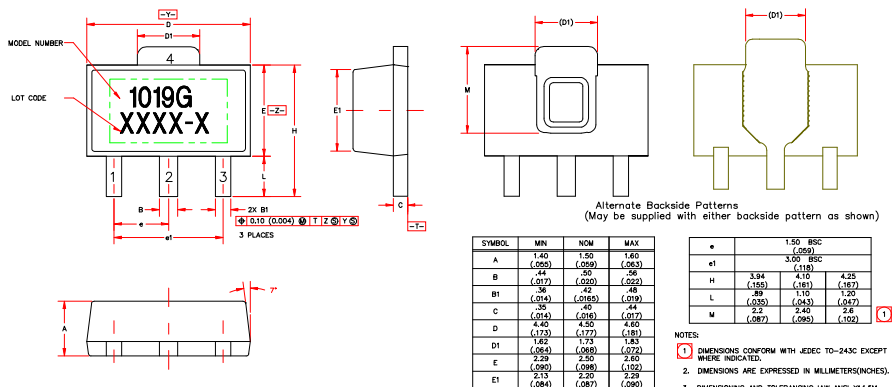

### Product Marking

The component will be marked with an "1019G" designator with an alphanumeric lot code on the top surface of the package. The obsolete tin-lead package is marked with an "1019" designator followed by an alphanumeric lot code.

Tape and reel specifications for this part are located on the website in the "Application Notes" section.

### Land Pattern

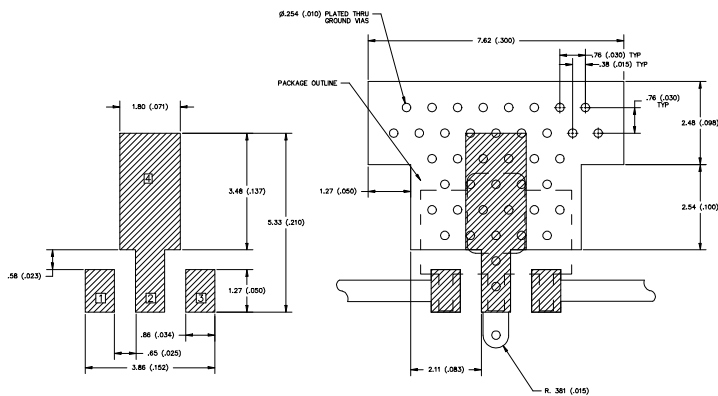

### MSL / ESD Rating



Caution! ESD sensitive device.

ESD Rating: Class 1A  
 Value: Passes between 250 and 500V  
 Test: Human Body Model (HBM)  
 Standard: JEDEC Standard JESD22-A114

MSL Rating: Level 3 at +260 °C convection reflow  
 Standard: JEDEC Standard J-STD-020

### Mounting Config. Notes

- Ground / thermal vias are critical for the proper performance of this device. Vias should use a .35mm (#80 / .0135") diameter drill and have a final plated thru diameter of .25 mm (.010").
- Add as much copper as possible to inner and outer layers near the part to ensure optimal thermal performance.
- Mounting screws can be added near the part to fasten the board to a heatsink. Ensure that the ground / thermal via region contacts the heatsink.
- Do not put solder mask on the backside of the PC board in the region where the board contacts the heatsink.
- RF trace width depends upon the PC board material and construction.
- Use 1 oz. Copper minimum.
- All dimensions are in millimeters (inches). Angles are in degrees.

### Thermal Specifications

Parameter	Rating
Operating Case Temperature	-40 to +85 °C
Thermal Resistance, Rth	128 °C/W