

Features

- Thick film hybrid
- Minimum output power - 15 W

Equivalent Circuit

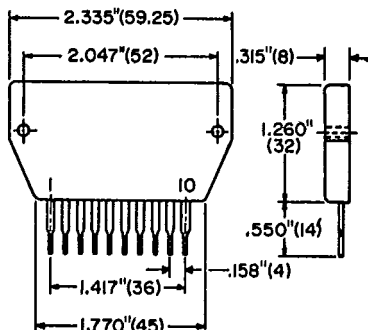
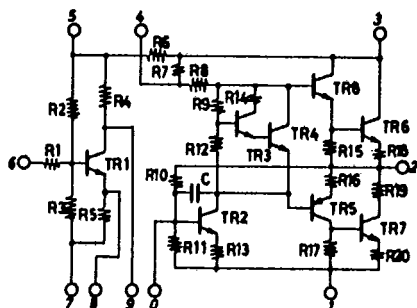

Absolute Maximum Ratings ($T_A =$

Characteristic	Symbol	Rating	Unit
Supply Voltage	V_{CC} (Pin 3 to 1)	54	V
Operating Case Temperature	T_C	85	$^{\circ}C$
Storage Temperature	T_{stg}	-30 to +100	$^{\circ}C$
Allowable Load Shorting Time	t_s $P_o = 15 W$ $f = 50 Hz$	2	sec

Operational Characteristics ($T_A = 25^{\circ}C$, $V_{CC} = 38 V$, $R_L = 8 \Omega$, $f = 1 kHz$, $R_g = 600 \Omega$)

Characteristic	Symbol	Test Condition	Min	Typ	Max	Unit
Quiescent Current	I_{CCO}		10	20	50	mA
Output Power	P_o	THD = 1.0%	15			W
Voltage Gain	VG	$P_o = 0.1 W$	32	33	34	dB
Input Resistance	r_i	$P_o = 0.1 W$	30K	40K		Ω
Output Resistance	r_o	$P_o = 0.1 W$		0.2		Ω
Distortion	THD	$P_o = 0.1 W$			0.3	%
Power Bandwidth	PBW	THD = 1.0%, -3 dB	30 to 30 K			Hz
Output Noise Voltage	V_{NO}	$R_g = 2.2 k\Omega$			0.8	mVrms
Frequency Channel High	f_{CH}	$V_i = 50 mV$, -3 dB	50 K			Hz
Frequency Channel Low	f_{CL}	$V_i = 50 mV$, -3 dB			30	Hz

Application

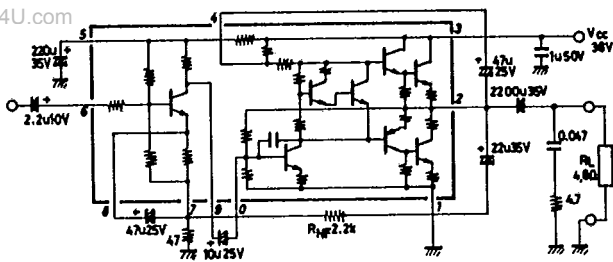

PC Board

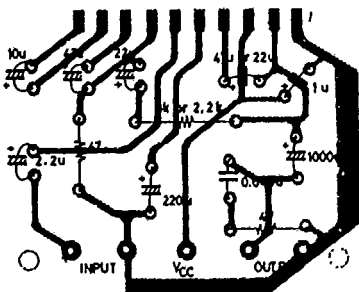

Typical Characteristics

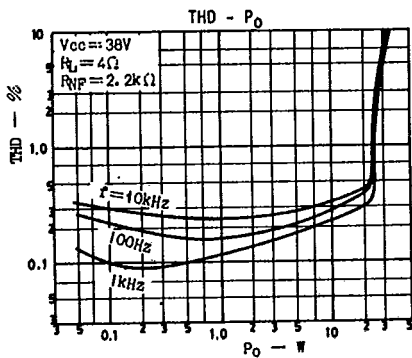
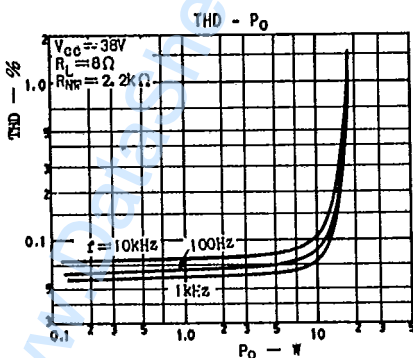
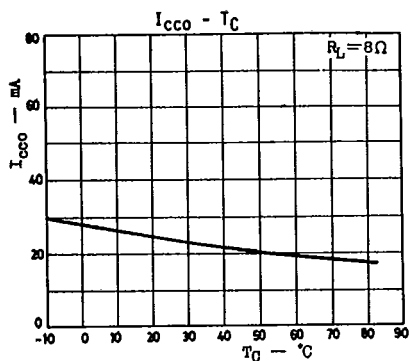
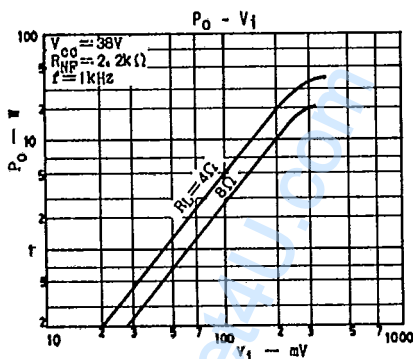

Typical Characteristics (Cont.)

www.DataSheet4U.com

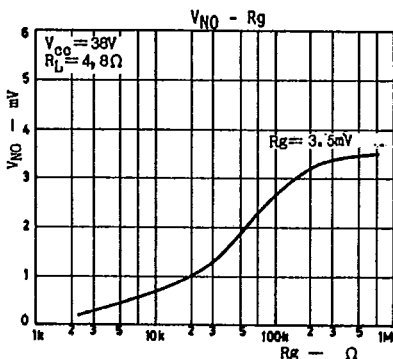
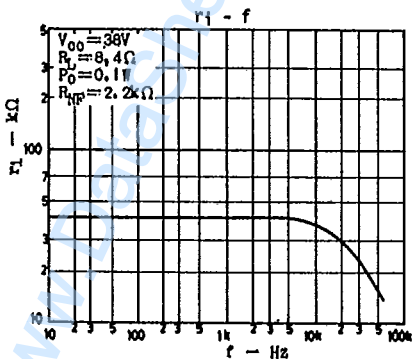
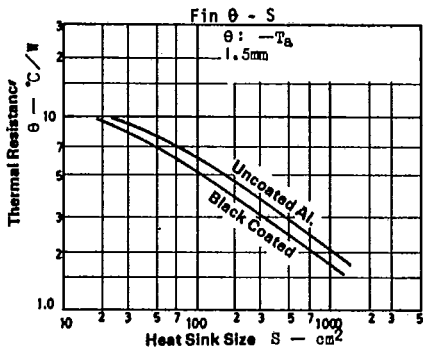
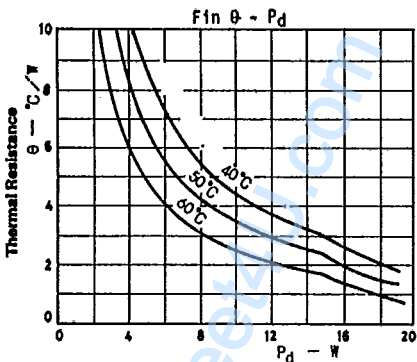
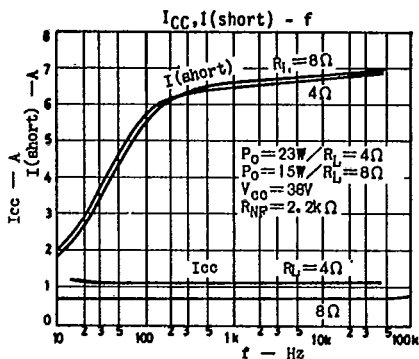
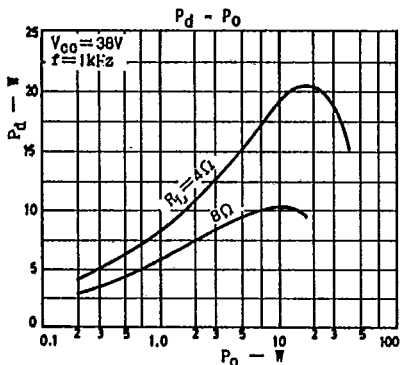
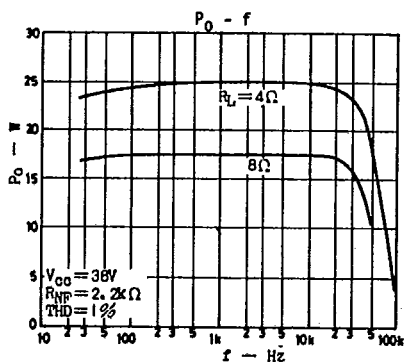
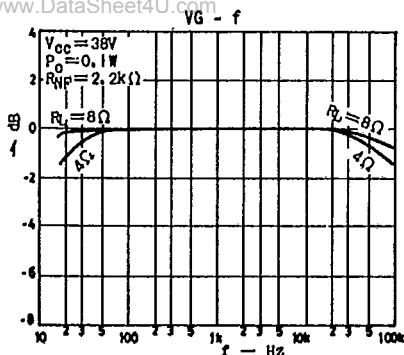

Typical Characteristics (Cont.)

$V_{NO} - V_{rp}$

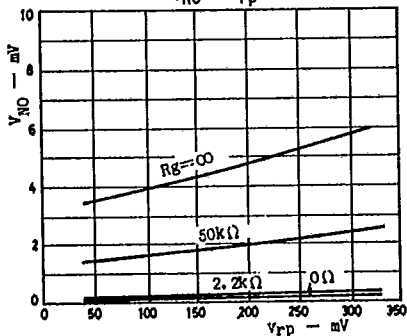

$V_N - V_{CC}$

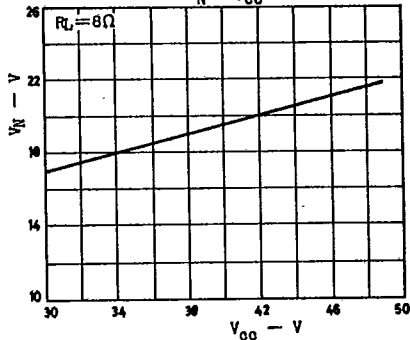

$P_o, I_{CC} - V_{CC}$

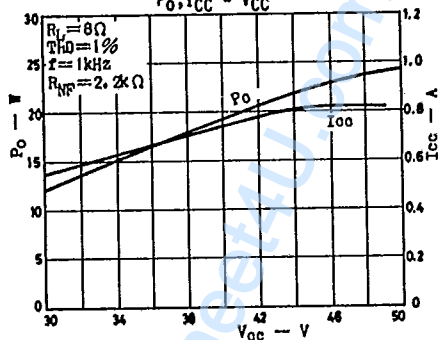

$P_o, I_{CC} - V_{CC}$

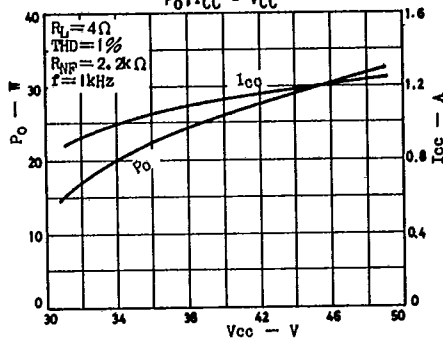

$V_N - V_{CC}$

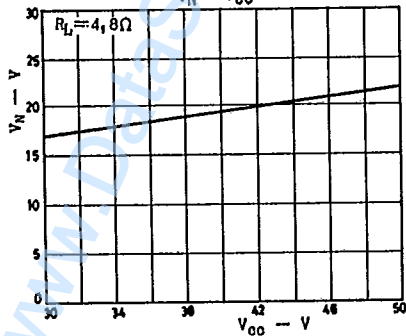

$I_{CCO} - V_{CC}$

