



ECP050D

1/2 Watt, High Linearity InGaP HBT Amplifier

The Communications Edge™

Product Information

Product Features

- 1800 – 2300 MHz
- +28.5 dBm P1dB
- +44 dBm Output IP3
- 14 dB Gain @ 1960 MHz
- +5V Single Positive Supply
- 16-pin 4x4mm lead-free/green/RoHS-compliant QFN Package

Applications

- Final stage amplifiers for Repeaters
- Mobile Infrastructure

Product Description

The ECP050D is a high dynamic range driver amplifier in a low-cost surface mount package. The InGaP/GaAs HBT is able to achieve high performance for various narrowband-tuned application circuits with up to +44 dBm OIP3 and +28.5 dBm of compressed 1dB power. It is housed in an industry standard in a lead-free/green/RoHS-compliant 16-pin 4x4mm QFN surface-mount package. All devices are 100% RF and DC tested.

The ECP050D is targeted for use as a driver amplifier in wireless infrastructure where high linearity and medium power is required. An internal active bias allows the ECP050D to maintain high linearity over temperature and operate directly off a single +5V supply. This combination makes the device an excellent candidate for transceiver line cards in current and next generation multi-carrier 3G base stations.

Functional Diagram

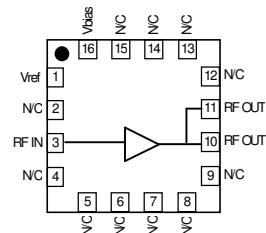

Function	Pin No.
Vref	1
RF Input	3
RF Output	10, 11
Vbias	16
GND	Backside Paddle
N/C or GND	2, 4-9, 12-15

Specifications ⁽¹⁾

Parameters	Units	Min	Typ	Max
Operational Bandwidth	MHz	1800		2300
Test Frequency	MHz		2140	
Gain	dB	12.5	14.4	
Input Return Loss	dB		23	
Output Return Loss	dB		8	
Output P1dB	dBm	+26.5	+28.5	
Output IP3 ⁽²⁾	dBm	+41	+42	
IS-95A Channel Power @ -45 dBc ACPR, 1960 MHz	dBm		+22.5	
wCDMA Channel Power @ -45 dBc ACLR, 2140 MHz	dBm		+20	
Noise Figure	dB		5.3	
Operating Current Range ⁽³⁾	mA	200	250	300
Device Voltage	V		+5	

1. Test conditions unless otherwise noted. 25 °C, Vsupply = +5 V in tuned application circuit.
2. 3OIP measured with two tones at an output power of +11 dBm/tone separated by 1 MHz. The suppression on the largest IM3 product is used to calculate the 3OIP using a 2:1 rule.
3. This corresponds to the quiescent current or operating current under small-signal conditions. It is expected that the current can increase up to 300mA at P1dB.

Typical Performance ⁽⁴⁾

Parameters	Units	Typical	
Frequency	MHz	1960	2140
Gain	dB	14.3	14.4
S11	dB	-12	-23
S22	dB	-8	-8
Output P1dB	dBm	+28.3	+28.5
Output IP3 ⁽²⁾	dBm	+44	+42
IS-95A Channel Power @ -45 dBc ACPR,	dBm	+22.5	
wCDMA Channel Power @ -45 dBc ACLR	dBm		+20
Noise Figure	dB	5	5.3
Supply Bias		+5 V @ 250 mA	

4. Typical parameters reflect performance in a tuned application circuit at +25 °C.

Absolute Maximum Rating

Parameter	Rating
Operating Case Temperature	-40 to +85 °C
Storage Temperature	-65 to +150 °C
RF Input Power (continuous)	+22 dBm
Device Voltage	+8 V
Device Current	400 mA
Device Power	2 W
Junction Temperature	+250 °C

Operation of this device above any of these parameters may cause permanent damage.

Ordering Information

Part No.	Description
ECP050D-G	1/2 Watt, High Linearity InGaP HBT Amplifier (lead-free/green/RoHS-compliant 16-pin 4x4mm QFN package)
ECP050D-PCB1960	1960 MHz Evaluation Board
ECP050D-PCB2140	2140 MHz Evaluation Board

Specifications and information are subject to change without notice



ECP050D

1/2 Watt, High Linearity InGaP HBT Amplifier

The Communications Edge™

Product Information

Typical Device Data

S-Parameters ($V_{cc} = +5\text{ V}$, $I_{cc} = 250\text{ mA}$, $T = 25\text{ }^\circ\text{C}$, unmatched 50 ohm system)

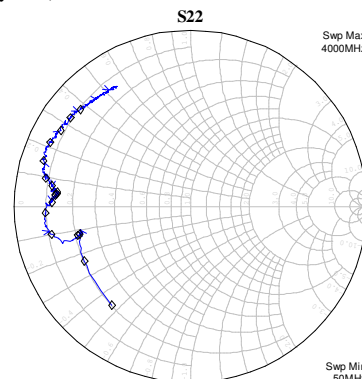
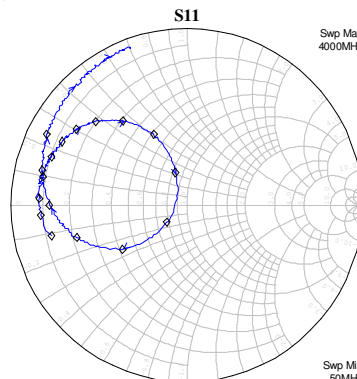
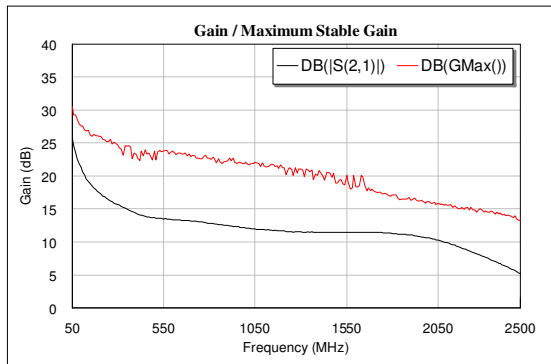

Notes:

The gain for the unmatched device in 50 ohm system is shown as the trace in black color. For a tuned circuit for a particular frequency, it is expected that actual gain will be higher, up to the maximum stable gain. The maximum stable gain is shown in the dashed red line. The return loss plots are shown from 50 – 5050 MHz, with markers placed at 0.05, .1 and 0.2 – 4.0 GHz in 0.2 GHz increments.

S-Parameters ($V_{cc} = +5\text{ V}$, $I_{cc} = 250\text{ mA}$, $T = 25\text{ }^\circ\text{C}$, unmatched 50 ohm system, calibrated to device leads)

Freq (MHz)	S11 (dB)	S11 (ang)	S21 (dB)	S21 (ang)	S12 (dB)	S12 (ang)	S22 (dB)	S22 (ang)
50	-2.07	-167.43	25.82	121.81	-35.26	26.47	-2.91	-128.35
100	-1.58	-176.05	21.20	119.20	-33.90	11.97	-3.41	-152.73
200	-1.51	177.40	17.44	119.80	-34.60	1.25	-3.78	-165.86
400	-1.57	168.78	14.35	113.14	-34.58	-8.55	-3.62	-165.62
600	-1.75	160.40	13.40	106.22	-34.07	-4.59	-1.91	-168.60
800	-1.99	153.13	12.87	92.25	-32.56	-14.00	-1.70	-177.42
1000	-2.37	145.53	12.13	78.04	-31.97	-20.72	-2.09	178.25
1200	-3.08	137.59	11.70	63.81	-30.73	-34.51	-2.30	175.18
1400	-4.45	127.27	11.49	48.38	-30.15	-45.41	-2.38	174.61
1600	-7.06	115.09	11.51	30.59	-28.93	-58.87	-2.40	173.92
1800	-14.14	108.91	11.31	7.41	-28.59	-86.40	-2.01	171.45
2000	-16.65	-139.80	10.59	-17.42	-28.25	-106.92	-1.57	168.88
2200	-7.09	-145.62	8.90	-43.17	-29.63	-131.87	-1.19	162.66
2400	-3.71	-163.79	6.54	-65.83	-30.95	-157.71	-1.17	155.41
2600	-2.13	179.97	3.92	-83.85	-33.01	-173.42	-1.40	149.55
2800	-1.44	166.49	1.29	-98.60	-36.04	168.07	-1.46	143.42
3000	-1.00	153.30	-1.17	-112.45	-38.83	154.12	-1.61	138.55

Device S-parameters are available for download off of the website at: <http://www.wj.com>

Application Circuit PC Board Layout

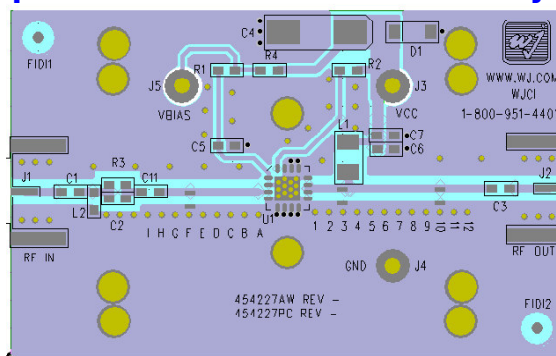

Circuit Board Material: .014" Getek, 4 - layer, 1 oz copper, Microstrip line details: width = .026", spacing = .026"
The silk screen markers 'A', 'B', 'C', etc. and '1', '2', '3', etc. are used as placemarkers for the input and output tuning shunt capacitors – C8, C9 and C10. The markers and vias are spaced in .050" increments.

Specifications and information are subject to change without notice



1960 MHz Application Circuit (ECP050D-PCB1960)

Typical RF Performance at 25 °C

Frequency	1960 MHz
S21 – Gain	14.3 dB
S11 – Input Return Loss	-12 dB
S22 – Output Return Loss	-8 dB
Output P1dB	+28.3 dBm
Output IP3 (+11 dBm / tone, 1 MHz spacing)	+44 dBm
Channel Power (@ -45 dBc ACPR, IS-95 9 channels fwd)	+22.5 dBm
Noise Figure	5 dB
Device / Supply Voltage	+5 V
Quiescent Current	250 mA

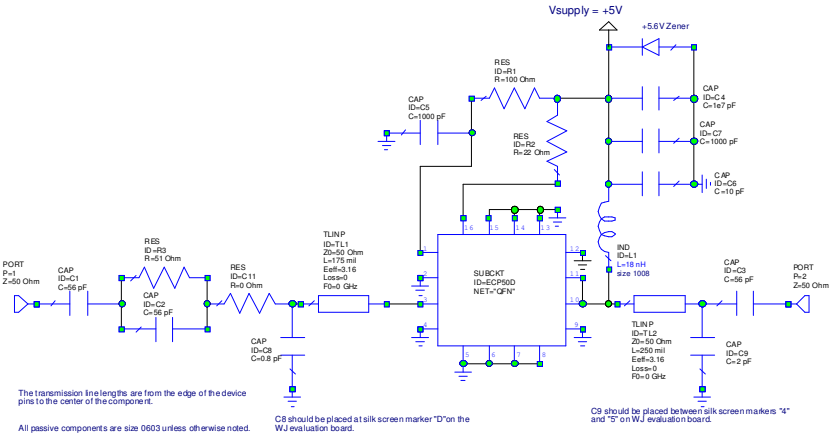

S21 vs. Frequency

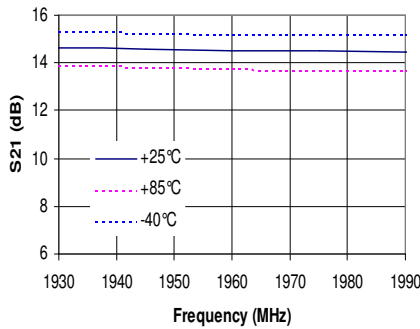

S11 vs. Frequency

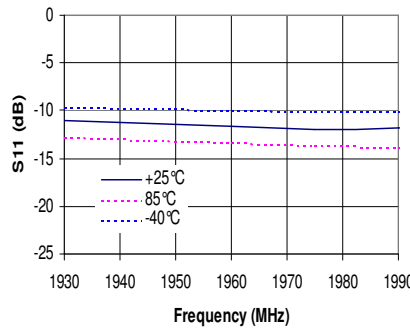

S22 vs. Frequency

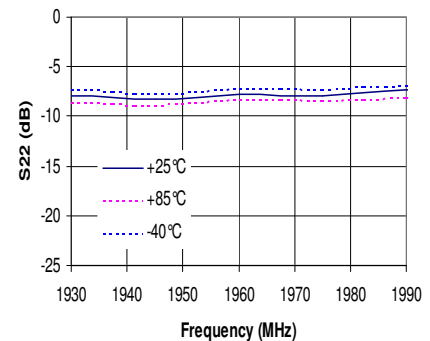

Noise Figure vs. Frequency

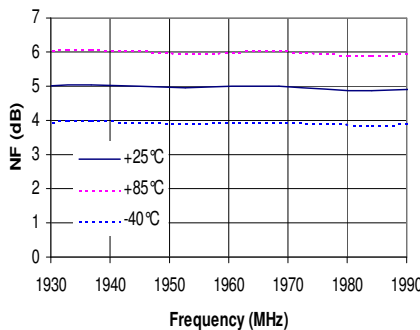

P1 dB vs. Frequency

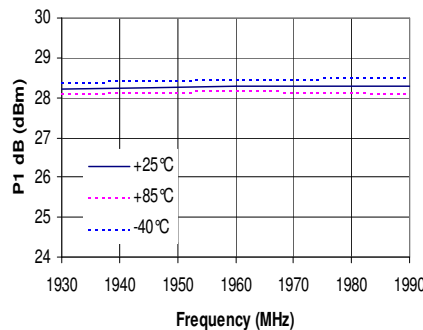

ACPR vs. Channel Power

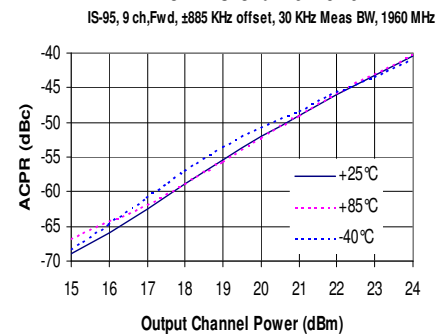

OIP3 vs. Output Power

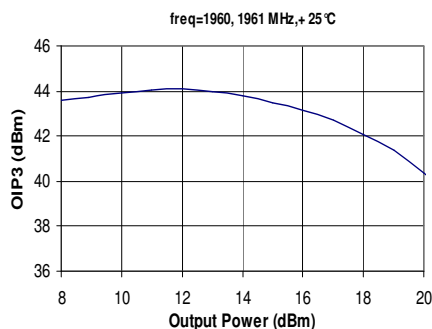

OIP3 vs. Frequency

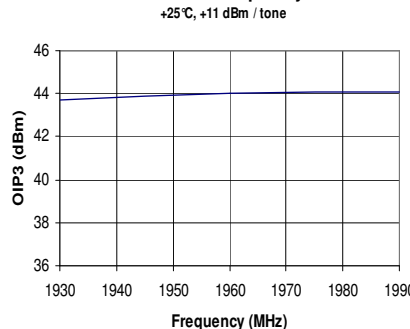

OIP3 vs. Temperature

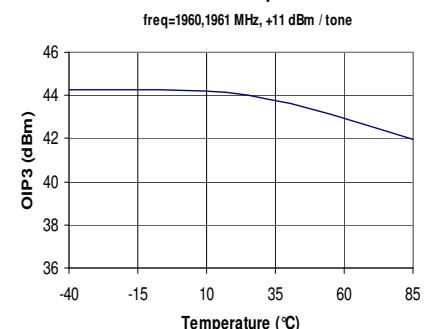



ECP050D

1/2 Watt, High Linearity InGaP HBT Amplifier

The Communications Edge™

Product Information

2140 MHz Application Circuit (ECP050D-PCB2140)

Typical RF Performance at 25 °C

Frequency	2140 MHz
S21 – Gain	14.4 dB
S11 – Input Return Loss	-23 dB
S22 – Output Return Loss	-8 dB
Output P1dB	+28.5 dBm
Output IP3 (+11 dBm / tone, 1 MHz spacing)	+42 dBm
W-CDMA Channel Power (@-45 dBc ACLR)	+20 dBm
Noise Figure	5.3 dB
Device / Supply Voltage	+5 V
Quiescent Current	250 mA

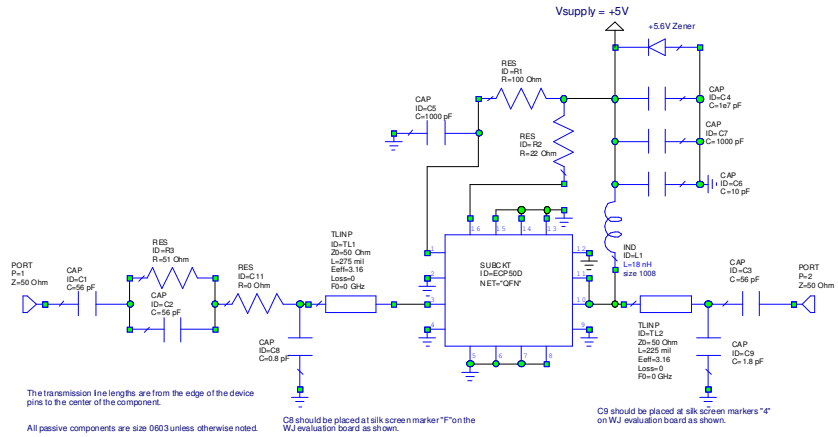

S21 vs. Frequency

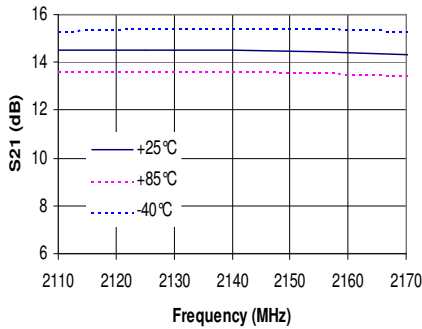

S11 vs. Frequency

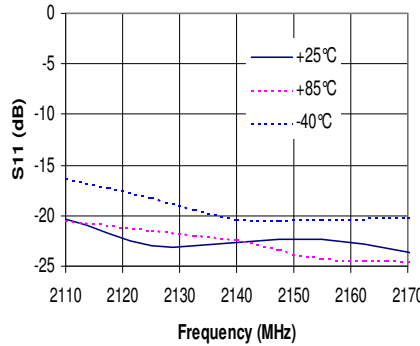

S22 vs. Frequency

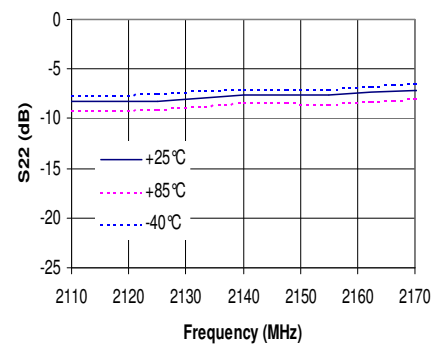

Noise Figure vs. Frequency

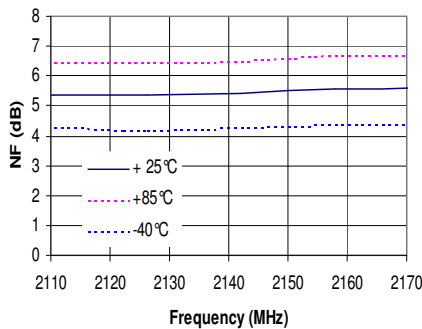

ACPR vs. Channel Power

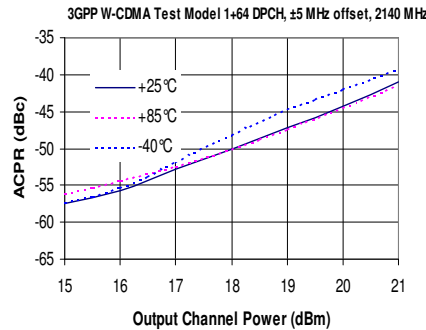

P1 dB vs. Frequency

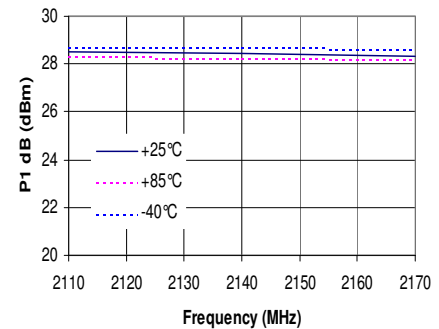

OIP3 vs. Frequency

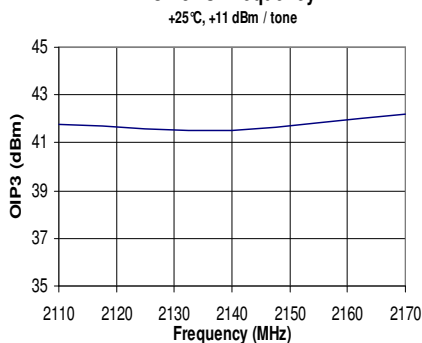

OIP3 vs. Temperature

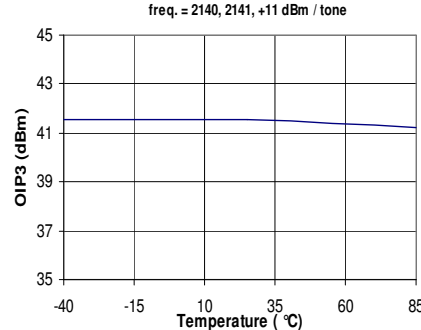

OIP3 vs. Output Power

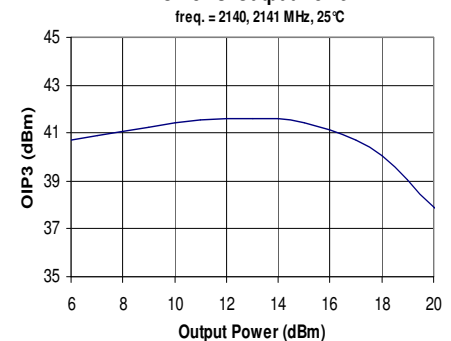

Specifications and information are subject to change without notice



ECP050D

1/2 Watt, High Linearity InGaP HBT Amplifier

The Communications Edge™

Product Information

ECP050D-G Mechanical Information

This package is lead-free/RoHS-compliant. It is compatible with both lead-free (maximum 260 °C reflow temperature) and leaded (maximum 245 °C reflow temperature) soldering processes. The plating material on the pins is annealed matte tin over copper.

Outline Drawing

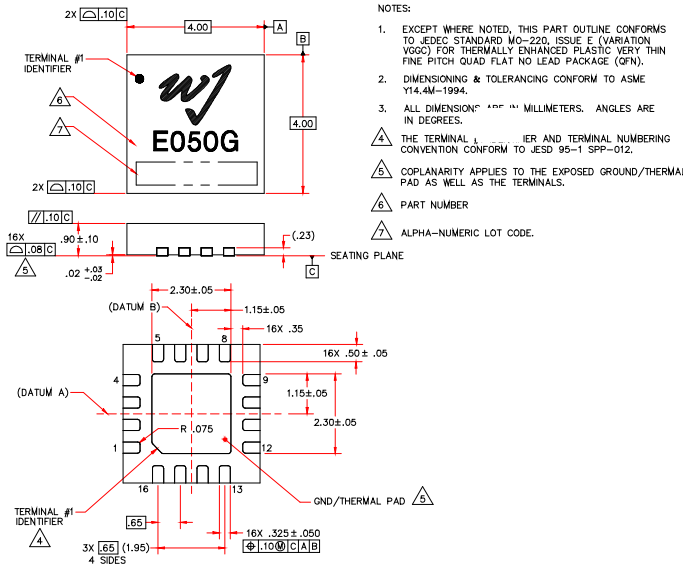

Land Pattern

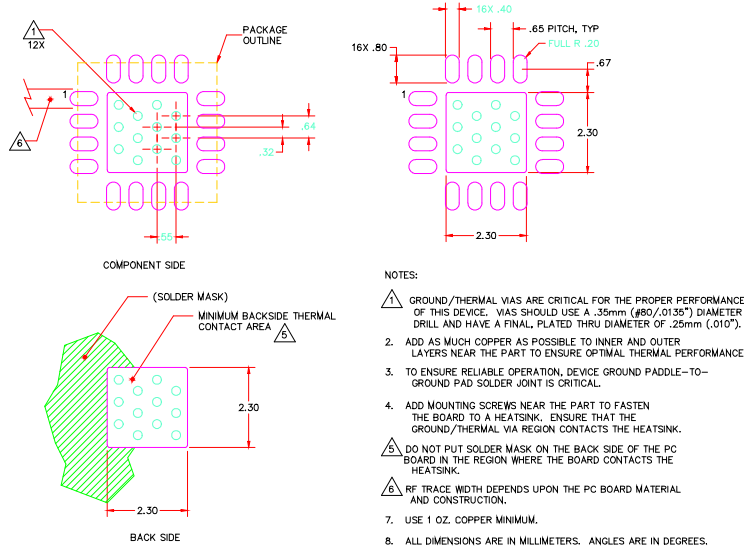

Product Marking

The component will be marked with an "E050G" designator with an alphanumeric lot code on the top surface of the package. The obsolete tin-lead package is marked with an "E050" designator followed by an alphanumeric lot code.

Tape and reel specifications for this part are located on the website in the "Application Notes" section.

ESD / MSL Information



Caution! ESD sensitive device.

ESD Rating: Class 1B
 Value: Passes between 500 and 1000V
 Test: Human Body Model (HBM)
 Standard: JEDEC Standard JESD22-A114

MSL Rating: Level 1 at +260 °C convection reflow
 Standard: JEDEC Standard J-STD-020

Mounting Config. Notes

- A heatsink underneath the area of the PCB for the mounted device is recommended for proper thermal operation.
- Ground / thermal vias are critical for the proper performance of this device. Vias should use a .35mm (#80 / .0135") diameter drill and have a final plated thru diameter of .25 mm (.010").
- Add as much copper as possible to inner and outer layers near the part to ensure optimal thermal performance.
- Mounting screws can be added near the part to fasten the board to a heatsink. Ensure that the ground / thermal via region contacts the heatsink.
- Do not put solder mask on the backside of the PCB board in the region where the board contacts the heatsink.
- RF trace width depends upon the PCB board material and construction.
- Use 1 oz. Copper minimum.
- All dimensions are in millimeters (inches). Angles are in degrees.

Thermal Specifications

Parameter	Rating
Operating Case Temperature	-40 to +85 °C
Thermal Resistance, Rth ⁽¹⁾	62 °C / W
Junction Temperature, Tj ⁽²⁾	162 °C

Notes:

- The thermal resistance is referenced from the junction-to-case at a case temperature of 85 °C. Tjc is a function of the voltage at pins 10 and 11 and the current applied to pins 10, 11, and 16 and can be calculated by:
 $T_j = T_{case} + R_{th} * V_{cc} * I_{cc}$
- This corresponds to the typical biasing condition of +5V, 250 mA at an 85 °C case temperature. A minimum MTTF of 1 million hours is achieved for junction temperatures below 247 °C.

MTTF vs. GND Tab Temperature

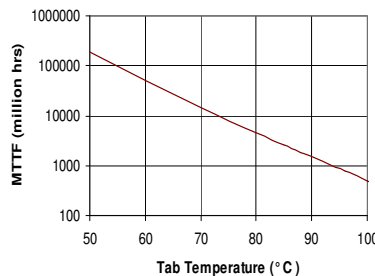

Specifications and information are subject to change without notice