



ECP052

1/2 Watt, High Linearity InGaP HBT Amplifier

The Communications Edge™

Product Information

Product Features

- 800 – 1000 MHz
- +28.5 dBm P1dB
- +44 dBm Output IP3
- 18 dB Gain @ 900 MHz
- Single Positive Supply (+5V)
- Available in SOIC-8 or 16pin 4mm QFN package

Applications

- Final stage amplifiers for Repeaters
- Mobile Infrastructure

Product Description

The ECP052 is a high dynamic range driver amplifier in a low-cost surface mount package. The InGaP/GaAs HBT is able to achieve high performance for various narrowband-tuned application circuits with up to +44 dBm OIP3 and +28.5 dBm of compressed 1dB power. It is housed in an industry standard SOIC-8 or 16-pin 4x4mm QFN SMT package. All devices are 100% RF and DC tested.

The ECP052 is targeted for use as a driver amplifier in wireless infrastructure where high linearity and medium power is required. An internal active bias allows the ECP052 to maintain high linearity over temperature and operate directly off a single +5V supply. This combination makes the device an excellent candidate for transceiver line cards in current and next generation multi-carrier 3G base stations.

Functional Diagram

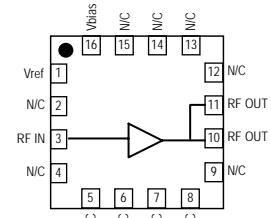

ECP052D

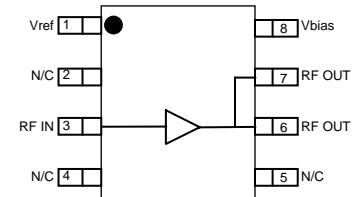

ECP052G

Specifications ⁽¹⁾

Parameter	Units	Min	Typ	Max
Operational Bandwidth	MHz	800		1000
Test Frequency	MHz		850	
Gain	dB	15.5	17	
Output P1dB	dBm	+27	+28	
Output IP3 ⁽²⁾	dBm	+42.5	+44	
Test Frequency	MHz		900	
Gain	dB	15.5	17.8	
Input Return Loss	dB		18	
Output Return Loss	dB		7	
Output P1dB	dBm	+27	+28.7	
Output IP3 ⁽²⁾	dBm	+42.5	+43	
IS-95A Channel Power @ -45 dBc ACPR, 1960 MHz	dBm		+23	
Noise Figure	dB		7	
Operating Current Range, I _{cc} ⁽³⁾	mA	200	250	300
Device Voltage, V _{cc}	V		+5	

1. Test conditions unless otherwise noted: 25°C, V_{supply} = +5 V, in tuned application circuit.
 2. 3OIP measured with two tones at an output power of +11 dBm/tone separated by 1 MHz. The suppression on the largest IM3 product is used to calculate the 3OIP using a 2:1 rule.
 3. This corresponds to the quiescent current or operating current under small-signal conditions into pins 6, 7, and 8. It is expected that the current can increase by an additional 50 mA at P1dB. Pin 1 is used as a reference voltage for the internal biasing circuitry. It is expected that Pin 1 will pull 12mA of current when used with a series bias resistor of R1=100Ω. (ie. total device current typically will be 262 mA.)

Absolute Maximum Rating

Parameters	Rating
Operating Case Temperature	-40 to +85 °C
Storage Temperature	-65 to +150 °C
RF Input Power (continuous)	+28 dBm
Device Voltage	+8 V
Device Current	400 mA
Device Power	2 W

Ordering Information

Part No.	Description
ECP052D	1/2 Watt InGaP HBT Amplifier (16p 4mm Pkg)
ECP052G	1/2 Watt InGaP HBT Amplifier (SOIC-8 Pkg)
ECP052D-PCB900	900 MHz Evaluation Board
ECP052G-PCB900	900 MHz Evaluation Board

Operation of this device above any of these parameters may cause permanent damage.

Specifications and information are subject to change without notice



Typical Device Data

S-Parameters ($V_{cc} = +5\text{ V}$, $I_{cc} = 250\text{ mA}$, $T = 25^\circ\text{C}$, unmatched 50 ohm system)

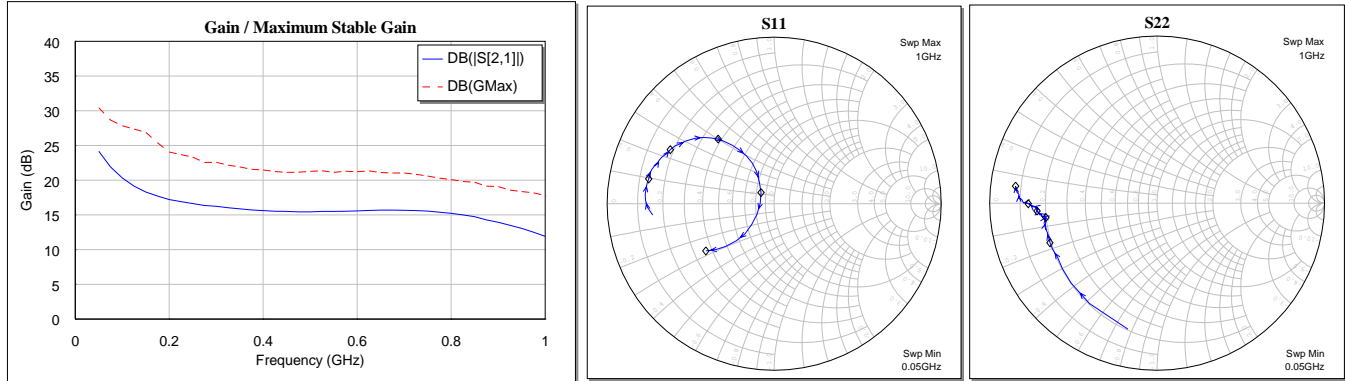

Notes:

The gain for the unmatched device in 50 ohm system is shown as the trace in black color. For a tuned circuit for a particular frequency, it is expected that actual gain will be higher, up to the maximum stable gain. The maximum stable gain is shown in the dashed red line. The return loss plots are shown from 50 – 1000 MHz, with markers placed at 0.2 – 1 GHz in 0.1 GHz increments.

S-Parameters ($V_{cc} = +5\text{ V}$, $I_{cc} = 250\text{ mA}$, $T = 25^\circ\text{C}$, unmatched 50 ohm system, calibrated to device leads)

Freq (MHz)	S11 (dB)	S21 (dB)	S21 (ang)	S12 (dB)	S12 (ang)	S22 (dB)	S22 (ang)
50	-2.72	24.16	133.35	-36.72	29.75	-2.23	-102.97
100	-2.25	20.33	124.95	-35.31	13.96	-3.08	-137.03
200	-2.31	17.23	119.37	-34.90	2.32	-3.32	-159.63
400	-3.08	15.63	98.28	-33.62	-16.36	-3.48	-172.70
600	-5.79	15.58	69.70	-32.10	-37.73	-2.87	-176.25
800	-19.72	15.22	25.60	-31.19	-78.95	-2.27	-179.74
1000	-6.06	11.91	-22.67	-33.26	-129.67	-1.40	173.15
1200	-2.34	6.92	-56.59	-38.16	176.95	-1.49	165.12
1400	-1.28	2.28	-78.59	-41.14	132.98	-1.96	160.84
1600	-0.91	-1.17	-96.56	-42.62	113.65	-2.53	160.80
1800	-0.71	-4.40	-112.20	-40.78	98.57	-2.92	157.57
2000	-0.60	-6.78	-128.36	-40.27	74.44	-3.29	155.77
2200	-0.58	-8.70	-146.80	-37.79	53.03	-3.72	155.24
2400	-0.55	-9.87	-169.80	-39.90	53.88	-3.96	158.19
2600	-0.51	-10.59	160.74	-37.66	41.18	-3.25	160.80
2800	-0.51	-11.66	128.82	-35.78	31.88	-1.97	158.05
3000	-0.54	-13.08	95.01	-35.88	27.61	-1.09	149.64

Application Circuit PC Board Layout

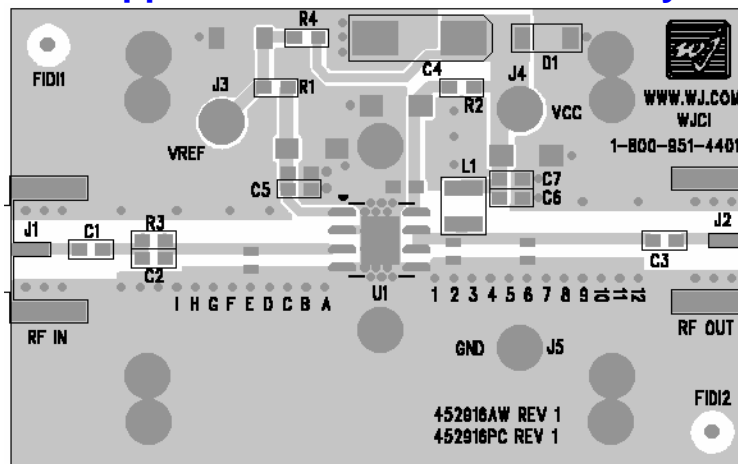

Circuit Board Material: .014" Getek, 4 - layer, 1 oz copper, Microstrip line details: width = .026", spacing = .026"
 The silk screen markers 'A', 'B', 'C', etc. and '1', '2', '3', etc. are used as placemarkers for the input and output tuning Shunt capacitors – C8 and C9. The markers and vias are spaced in .050" increments.

Specifications and information are subject to change without notice



900 MHz Application Circuit (ECP052G-PCB900)

Typical RF Performance at 25°C

Frequency	900 MHz
S21 – Gain	17.5 dB
S11 – Input Return Loss	-18 dB
S22 – Output Return Loss	-7 dB
Output P1dB	+28.7 dBm
Output IP3 (+11 dBm / tone, 1 MHz spacing)	+43 dBm
Channel Power (@-45 dBc ACPR, IS-95 9 channels fwd)	+23 dBm
Noise Figure	7 dB
Device / Supply Voltage	+5 V
Quiescent Current	250 mA

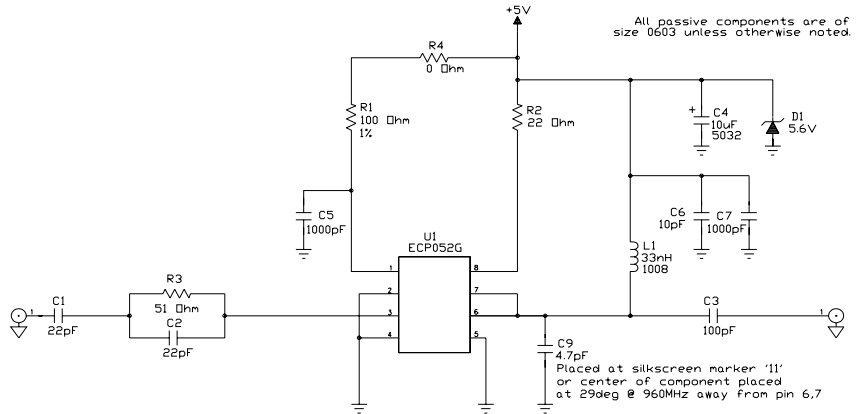

S21 vs Frequency

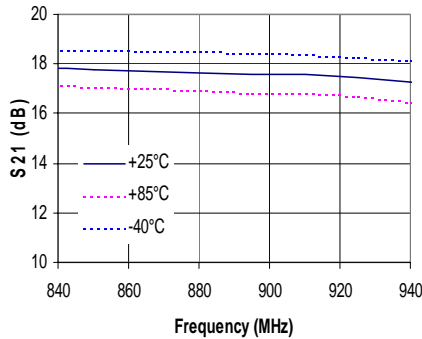

S11 vs. Frequency

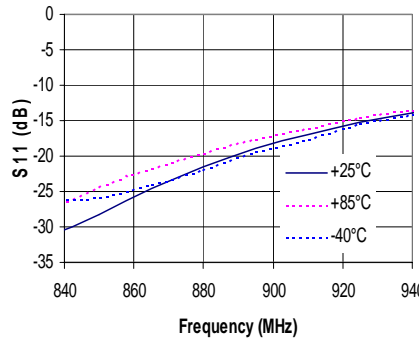

S22 vs. Frequency

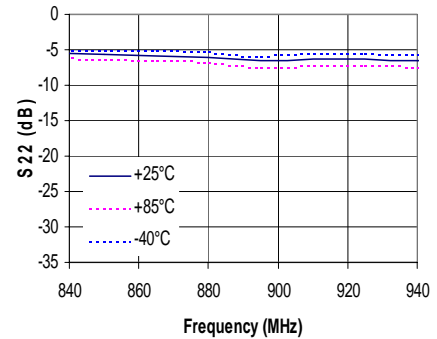

Noise Figure vs. Frequency

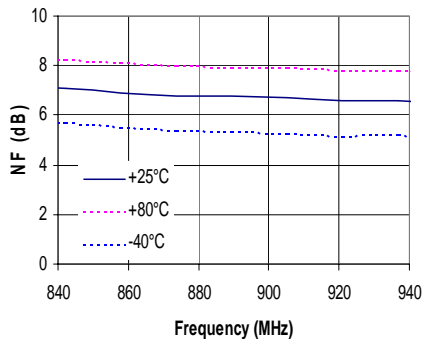

P1 dB vs. Frequency

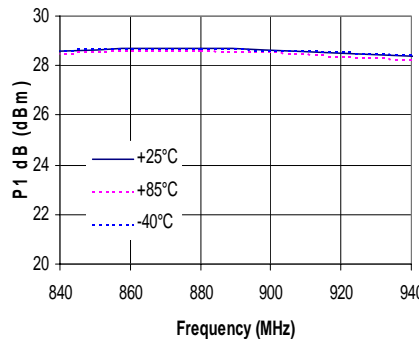

ACPR vs. Channel Power
IS-95, 9 Ch. Fwd, ±885KHz Meas BW, 900 MHz

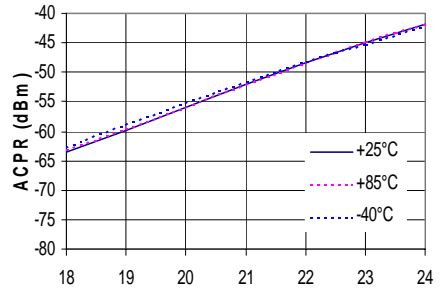

OIP3 vs. Temperature

freq. = 900, 901 MHz, +13 dBm /tone

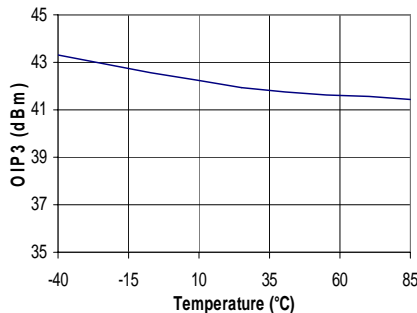

OIP3 vs. Output Power

freq. = 900, 901 MHz, +25°C

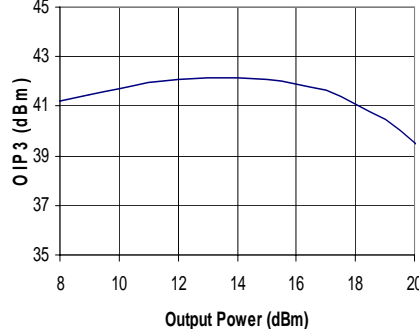

Output Channel Power (dBm)

OIP3 vs. Frequency

+25°, +13 dBm / tone

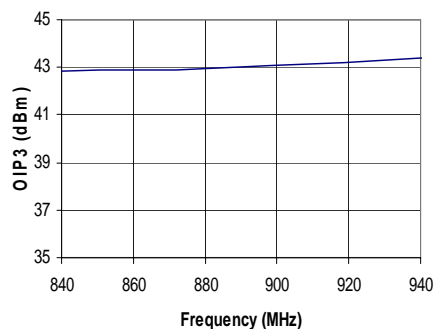



ECP052

1/2 Watt, High Linearity InGaP HBT Amplifier

The Communications Edge™

Product Information

ECP052G (SOIC-8 Package) Mechanical Information

Outline Drawing

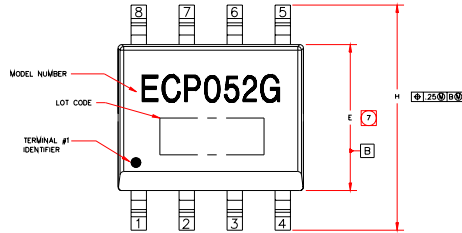

- NOTES:
- EXCEPT WHERE NOTED, THIS PART OUTLINE CONFORMS TO JEDEC STANDARD MS-012, ISSUE C FOR SMALL OUTLINE (SO) PERIPHERAL TERMINALS, 3.25mm BODY WIDTH (PLASTIC).
 - DIMENSIONING & TOLERANCING CONFORM TO ASME Y14.4M-1994.
 - ALL DIMENSIONS ARE IN MILLIMETERS. ANGLES ARE IN DEGREES.
 - DOES NOT INCLUDE MOLD FLASH, PROTRUSIONS OR GATE BURRS, WHICH SHALL NOT EXCEED .15mm(.006in) PER SIDE.
 - DEVIATION FROM JEDEC MS-012 STANDARD.
 - LENGTH OF TERMINAL FOR SOLDERING TO A SUBSTRATE.
 - DOES NOT INCLUDE INTER-LEAD FLASH OR PROTRUSIONS, WHICH SHALL NOT EXCEED .25mm(.010in) PER SIDE.

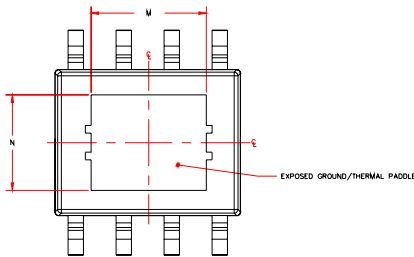
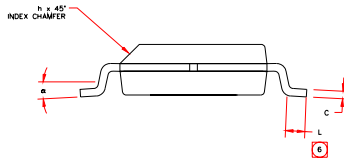
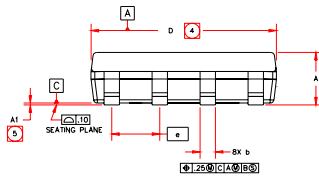

SYMBOL	MILLIMETERS		INCHES	
	MIN.	MAX.	MIN.	MAX.
A	1.30	1.50	.051	.059
A1	0	.10	0	.004
b	.38	.43	.015	.017
C	.18	.23	.007	.009
D	4.80	5.00	.189	.197
E	3.80	4.00	.150	.157
e	1.27 BSC		.050 BSC	
H	5.80	6.20	.228	.244
h	.25	.30	.01	.02
L	.40	1.27	.016	.050
M	2.95	3.15	.116	.124
N	2.03	2.54	.080	.100
a	0	9°	0	9°

Land Pattern

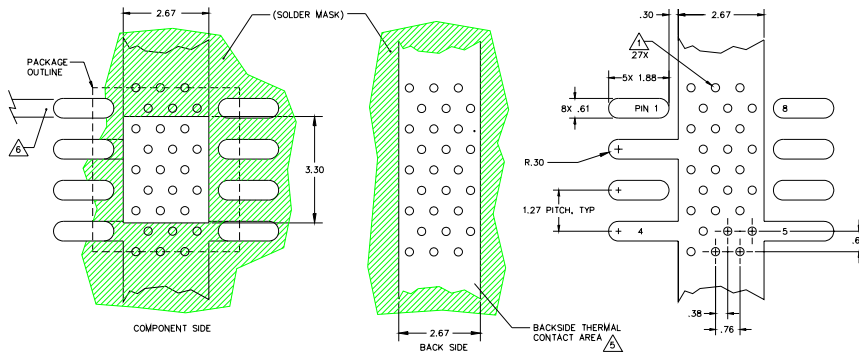

Thermal Specifications

Parameter	Rating
Operating Case Temperature	-40 to +85° C
Thermal Resistance, Rth ⁽¹⁾	62° C / W
Junction Temperature, Tjc ⁽²⁾	162° C

Notes:

1. The thermal resistance is referenced from the junction-to-case at a case temperature of 85° C. Tjc is a function of the voltage at pins 6 and 7 and the current applied to pins 6, 7, and 8 and can be calculated by:

$$T_{jc} = T_{case} + R_{th} * V_{cc} * I_{cc}$$

2. This corresponds to the typical biasing condition of +5V, 250 mA at an 85° C case temperature. A minimum MTTF of 1 million hours is achieved for junction temperatures below 247° C.

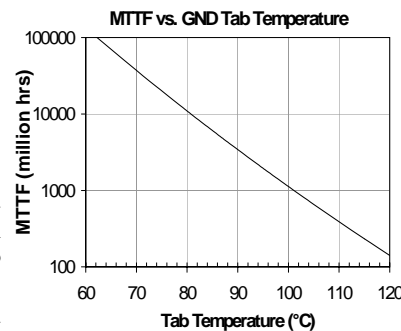

Product Marking

The component will be marked with an "ECP052G" designator with an alphanumeric lot code on the top surface of the package.

Tape and reel specifications for this part are located on the website in the "Application Notes" section.

ESD / MSL Information

ESD Rating: Class 1B
 Value: Passes between 500 and 1000V
 Test: Human Body Model (HBM)
 Standard: JEDEC Standard JESD22-A114

MSL Rating: Level 3 at +235° C convection reflow
 Standard: JEDEC Standard J-STD-020

Functional Diagram

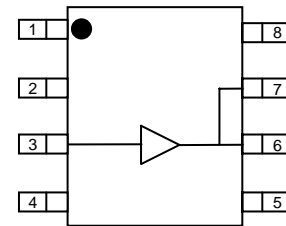

Function	Pin No.
Vref	1
Input	3
Output	6, 7
Vbias	8
GND	Backside Paddle
N/C or GND	2, 4, 5

Mounting Config. Notes

- A heatsink underneath the area of the PCB for the mounted device is strictly required for proper thermal operation. Damage to the device can occur without the use of one.
- Ground / thermal vias are critical for the proper performance of this device. Vias should use a .35mm (#80 / .0135") diameter drill and have a final plated thru diameter of .25 mm (.010").
- Add as much copper as possible to inner and outer layers near the part to ensure optimal thermal performance.
- Mounting screws can be added near the part to fasten the board to a heatsink. Ensure that the ground / thermal via region contacts the heatsink.
- Do not put solder mask on the backside of the PC board in the region where the board contacts the heatsink.
- RF trace width depends upon the PC board material and construction.
- Use 1 oz. Copper minimum.
- All dimensions are in millimeters (inches). Angles are in degrees.

Specifications and information are subject to change without notice



ECP052D (16-pin 4x4mm Package) Mechanical Information

Outline Drawing

NOTE: ALL DIMENSIONS ARE IN MILLIMETERS

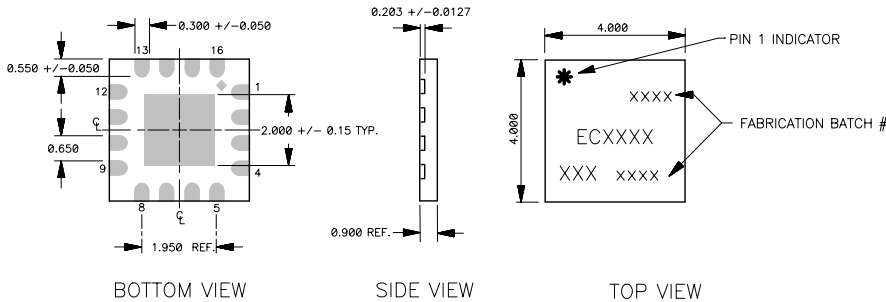

Product Marking

The component will be marked with an "ECP052D" designator with an alphanumeric lot code on the top surface of the package.

Tape and reel specifications for this part are located on the website in the "Application Notes" section.

ESD / MSL Information

ESD Rating: Class 1B
 Value: Passes between 500 and 1000V
 Test: Human Body Model (HBM)
 Standard: JEDEC Standard JESD22-A114

MSL Rating: Level 3 at +235° C convection reflow
 Standard: JEDEC Standard J-STD-020

Land Pattern

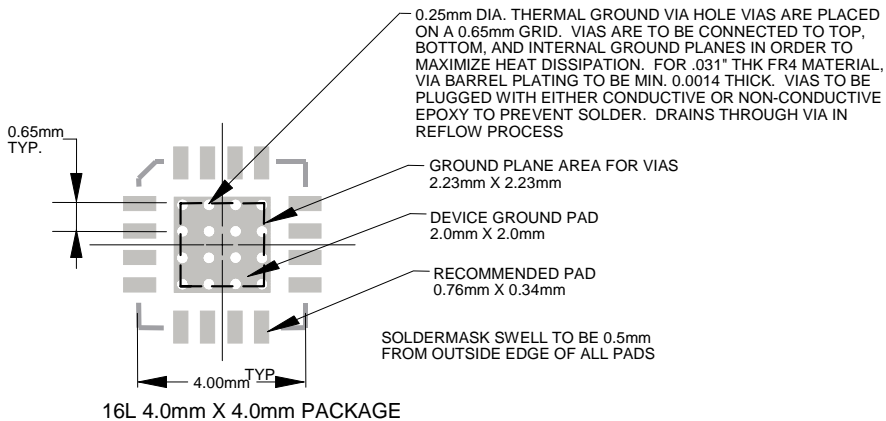

Functional Diagram

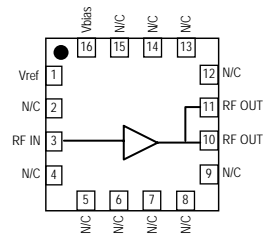

Function	Pin No.
Vref	1
RF Input	3
RF Output	10, 11
Vbias	16
GND	Backside Paddle
N/C or GND	2, 4-9, 12-15

Thermal Specifications

Parameter	Rating
Operating Case Temperature	-40 to +85° C
Thermal Resistance, Rth ⁽¹⁾	62° C / W
Junction Temperature, Tjc ⁽²⁾	162° C

Notes:

1. The thermal resistance is referenced from the junction-to-case at a case temperature of 85° C. Tjc is a function of the voltage at pins 10 and 11 and the current applied to pins 10, 11, and 16 and can be calculated by:

$$T_{jc} = T_{case} + R_{th} * V_{cc} * I_{cc}$$

2. This corresponds to the typical biasing condition of +5V, 250 mA at an 85° C case temperature. A minimum MTTF of 1 million hours is achieved for junction temperatures below 247° C.

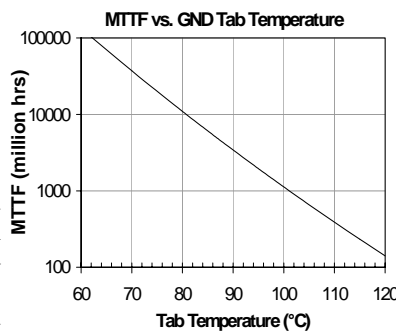

Mounting Config. Notes

1. A heatsink underneath the area of the PCB for the mounted device is strictly required for proper thermal operation. Damage to the device can occur without the use of one.
2. Ground / thermal vias are critical for the proper performance of this device. Vias should use a .35mm (#80 / .0135") diameter drill and have a final plated thru diameter of .25 mm (.010").
3. Add as much copper as possible to inner and outer layers near the part to ensure optimal thermal performance.
4. Mounting screws can be added near the part to fasten the board to a heatsink. Ensure that the ground / thermal via region contacts the heatsink.
5. Do not put solder mask on the backside of the PC board in the region where the board contacts the heatsink.
6. RF trace width depends upon the PC board material and construction.
7. Use 1 oz. Copper minimum.
8. All dimensions are in millimeters (inches). Angles are in degrees.

Specifications and information are subject to change without notice